



#### Future Stores

London, Oxford Street  
400sqm dvLED wall using **System Xpert**

**B Tech**<sup>®</sup>  
AV Mounts

Full Range  
**Product Catalogue**  
2025 / 2026

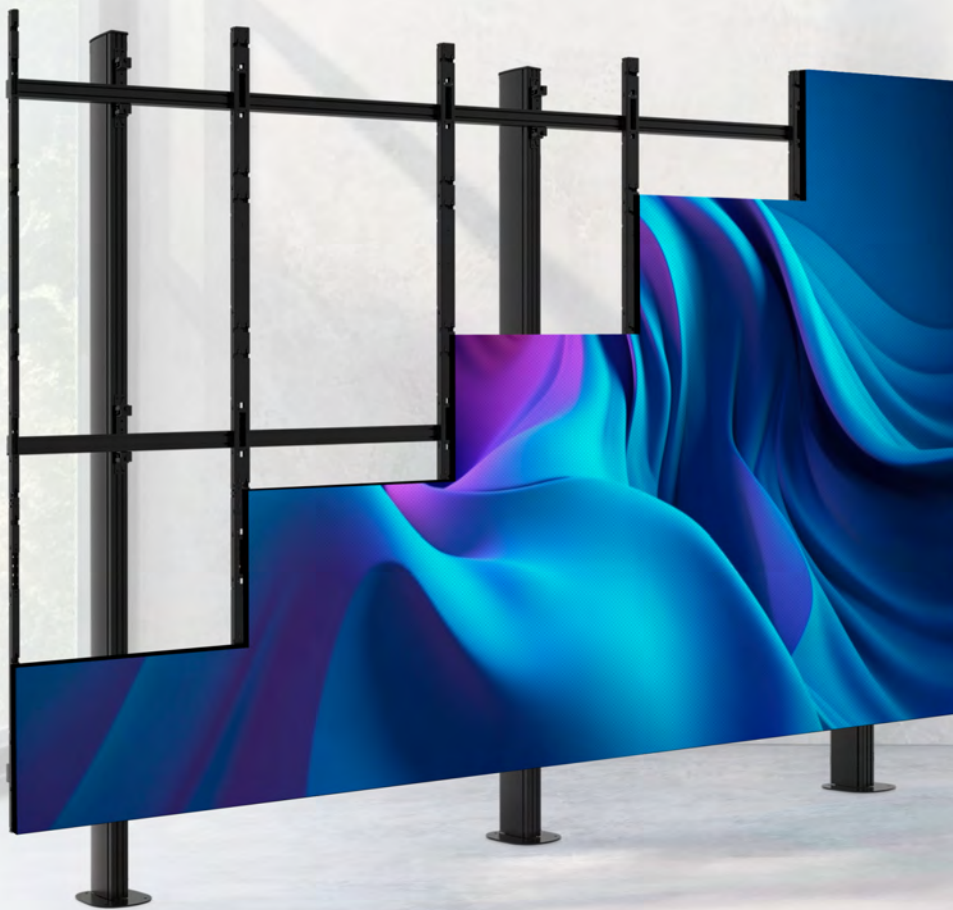

In 2022, B-Tech partnered with IT mounting specialist Neomounts to form the **Global Mounts Group**; an all-encompassing mounting specialist serving both the AV and IT channels. In 2024, the Global Mounts Group acquired Audipack, a renowned manufacturer of high-end and custom-made mounting solutions (see page 112 for more details about Audipack products). Together, we offer the industry's most comprehensive portfolio and a global distribution network, establishing ourselves as a true one-stop shop for any mounting solution.



## B-Tech Online

For company info, product specs, assembly manuals, configuration tools, PR and media files, please visit: [www.btechavmounts.com](http://www.btechavmounts.com)



Connect with B-Tech



@btechavmounts



Subscribe to our mailing list for the latest news, event details and product launches [www.btechavmounts.com/mailling-list](http://www.btechavmounts.com/mailling-list)

# Welcome to the latest edition of the B-Tech AV Mounts Catalogue

2024 was a very busy year for B-Tech's product development department, and we also saw the addition of a brand new partner joining us in the Global Mounts Group. The result of which is a large number of exciting new additions to the 2025 catalogue, including the release of one of our most important ranges of the past few years - our new stockable dvLED mounting system - System Xpress. Alongside this a major new marketing initiative was introduced, with several new named ranges introduced as part of their respective product launches. These names, along with individual identifiers attached to each product, help to make it easier to identify and select a suitable mounting solution that is just right for your installation, please see below for a brief overview and then head over to the page shown to check them out!

Established in London in 1972, B-Tech AV Mounts is an industry leader in the design and manufacture of professional AV mounting solutions, whose products are recognised globally for their innovation, robustness, reliability, ease of install and design aesthetics. With strategically located offices and distribution centres around the world, B-Tech provides a truly global localised service. B-Tech AV Mounts not only offers one of the most extensive but also the most versatile and adaptable mounting ranges available from any mounting solutions provider.

B-Tech mounting solutions cover all AV requirements ranging from small, single screens to large format displays, projectors, speakers, interactive touchscreens and UC equipment, as well as large, multi-screen LCDS and dvLED video walls and digital signage. Designed to stringent TUV and UL safety standards by B-Tech's in-house team of engineers, our products are available as wall or ceiling mounts, desktop stands or as freestanding, mobile or bolt-down floor stands. Winners of multiple accolades including AV Awards' AV Manufacturer of the Year crown, B-Tech AV Mounts products are found in prestigious hotels, shopping malls, government facilities, corporate offices, sports stadia, restaurants, airports and conference facilities worldwide.

## New for 2025 Brand New Named Product Ranges

SYSTEM **XPERT** Pg.22

The pros choice; feature rich dvLED mounts for the best install experience

SYSTEM **XPRESS** Pg.28

Quick to order and ship: stockable dvLED mounts for popular configurations

**momentum** Pg.74

Our latest range of mobile solutions

**vantage** Pg.55

Premium articulated wall mounts with our new UltraGlide technology

**elements** Pg.55













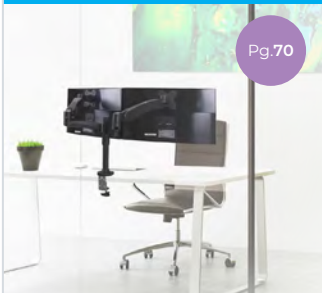

Offering fundamental features at affordable price points

**flex** Pg.70

Our latest range of Full Motion Desk Mounts



**Complete Mounting Solutions** contain everything you need to mount your AV equipment. These products cover the most common wall, ceiling or floor mounting requirements and include solutions for flat screens, projectors, speakers and specialist digital signage applications such as large scale videowalls, menu boards and dvLED. For these larger installs, combination kits are usually provided, which have multiple parts that make up the solution. These are treated just like any small, simple one-box product - all you need to order is a single part code... we'll make sure everything is included.

<b>dvLED Mounting Solutions</b>  Pg.18	<b>Menu Board &amp; Videowall Mounting Systems</b>  Pg.34	<b>Digital Signage</b>  Pg.46	<b>Flat Screen Wall Mounts</b>  Pg.54
<b>Flat Screen Ceiling Mounts</b>  Pg.66	<b>Flat Screen Desk Mounts</b>  Pg.70	<b>Floor Stands &amp; Mobile Solutions</b>  Pg.74	<b>UC / VC Display Stands</b>  Pg.88
<b>Media Storage Devices &amp; Shelves</b>  Pg.96	<b>Speaker Mounts</b>  Pg.103	<b>UC / VC Video Bar Mounts</b>  Pg.104	<b>Projector Ceiling Mounts</b>  Pg.108
<b>System X Components</b>  Pg.116 <b>SYSTEM X</b>	<b>System 2 Components</b>  Pg.132 <b>SYSTEM 2</b>	<b>Floor Stand Components</b>  Pg.146	<b>System V Components</b>  Pg.152 <b>SYSTEM V</b>

**Component Ranges** are modular based systems designed to create custom solutions to suit almost any application. The adaptability of System X, System 2, System V, and our Floor Stand Range allows for an almost endless number of mounting configurations. Our range of components includes freestanding or mobile bases, an extensive selection of wall and ceiling mounts, and various screen interface arms. Screen mounts that feature the collar-compatible icon can be fitted to our System 2 poles and System X columns to create ceiling mounts and floor stands. System X can also be used with System 2 poles for specialist ceiling requirements.

<b>Intro</b>	<b>Pg.3</b>	<b>Premium UC/VC Display Stands</b>	<b>Pg.88</b>
Contents	4-5	Mode-AL Single Screen UC Display Stands	90-92
About B-Tech AV Mounts	6-9	Mode-AL Twin Screen VC Display Stands	93
<b>Complete Mounting Solutions</b>	<b>Pg.10</b>	Mode-AL Mounting Guide	94-95
Quick Ref. Guide: Multi-Screen and Digital Signage Mounts	10-11	<b>Media Storage Devices &amp; Shelves</b>	<b>Pg.96</b>
Quick Ref. Guide: Trolleys / Floor Stands	12-13	Flat Screen Mounts with AV Media Storage	98
Quick Ref. Guide: Flat Screen Wall Mounts	14-15	AV Storage Mounts	99
Quick Ref. Guide: Additional Mounting Solutions	16-17	Specialist Mounts & AV Component Shelves	100
<b>dvLED Mounting Solutions</b>	<b>Pg.18</b>	AV Component Shelves	101
System Xpert dvLED Mounts & Stands	22-27	AV Accessory Mounting Arms	102
System Xpress Mounts & Stands - Pre-Packaged Kits	28-29	Speaker Wall Mounts	103
System Xpress Mounts & Stands - Custom Kits	30-31	Universal Soundbar Mount	103
System All-In-One Mounting Solutions	32-33	<b>UC/VC Video Bar &amp; Camera Mounts</b>	<b>Pg.104</b>
<b>Menu Board &amp; Videowall Mounts</b>	<b>Pg.34</b>	Video Bar & Camera Mounts	106 - 107
Menu Board Mounting Systems	36	<b>Projector Ceiling Mounts</b>	<b>Pg.108</b>
Videowall Mounting Systems	37	Projector Ceiling Mounts	110
Videowall Stands	38	Heavy Duty Projector Ceiling Mounts	111
Curved Videowall Stands	39	<b>Audipack Mounting Solutions</b>	<b>Pg.112</b>
<b>Modular Videowall Mounts</b>	<b>Pg.42</b>	<b>Component Ranges</b>	<b>Pg.114</b>
Modular Videowall Mounts	44	<b>System X Components</b>	<b>Pg.116</b>
Full Service Wall Mounts	45	System X: Mounting Rails & Wall Fixing Kits	126
<b>Specialist Mounts &amp; Digital Signage Solutions</b>	<b>Pg.46</b>	System X: Support Columns & Mounting Rail Joining Kits	127
XXL Specialist Wall Mounts	48	System X: Bases	128
Digital Signage Wall Mounts	49	System X: Interface Arms	129 - 130
Digital Signage Kiosks	50	System X: Mounting Accessories	131
Digital Signage Stands	51-53	<b>System 2 Components</b>	<b>Pg.132</b>
<b>Flat Screen Wall Mounts</b>	<b>Pg.54</b>	System 2: Poles	140
Flat Screen Wall Mounts VESA 100	56-57	System 2: Ceiling Mounts	141
Flat Screen Wall Mounts VESA 200	58-59	System 2: Specialist Pole Mounts	142
Flat Screen Wall Mounts VESA 400	60	System 2: Accessory Collars	143
Flat Screen Wall Mounts VESA 600	61 - 63	System 2: Accessories	144
Flat Screen Wall Mounts VESA 800	62	System 2: Camera & Projector Mounts	145
Flat Screen Wall Mounts VESA 1000	64	<b>Floor Stand Components</b>	<b>Pg.146</b>
VESA Adaptors	65	Floor Stand Bases	150
<b>Flat Screen Ceiling Mounts</b>	<b>Pg.66</b>	Floor Stand Vertical Supports & Accessories	151
Flat Screen Ceiling Mounts VESA 100 / 200 / 600	67	<b>System V Components</b>	<b>Pg.152</b>
Flat Screen Ceiling Mounts VESA 600	68	System V: Poles & Ceiling Mounts	156
Flat Screen Ceiling Mounts VESA 1000	69	System V: Camera Mounts & Accessories	157
<b>Flat Screen Desk Mounts</b>	<b>Pg.70</b>	<b>Surveillance &amp; Security Mounting Solutions</b>	<b>Pg.158</b>
Full Motion Desk Mounts	71	Camera & Screen Ceiling Mounts	160
Premium Desk Mounts	72	Flat Screen Ceiling Mounts	161
Premium Heavy Duty Mounts	73	<b>Index</b>	<b>Pg.162</b>
<b>Floor Stands &amp; Mobile Solutions</b>	<b>Pg.74</b>		
Designer Trolleys	76		
Flat Screen Trolleys	77- 79		
Interactive Touchscreen Trolleys	78		
Motorised Height Adjustable Display Trolleys / Stands	80		
Low Level Flat Screen Display Stands	81		
Flat Screen Floor Stands  Poles	82		
System X Flat Screen Floor Stands	83		
Twin Screen Floor Stands	84		
Twin Screen VC Trolleys	85		
XL Twin Screen VC Floor Stands	86		
Twin Screen VC Wall Mounts	87		

## QR Codes

All products in the catalogue feature QR codes that you can scan to access the product's dedicated web page. There, you'll find the full product specifications, features, images, assembly manuals, and specification sheets.



Worldwide Installations



Control Rooms

Education

Security

Government

## Why Choose B-Tech?

### Comprehensive Product Range

Our extensive catalogue features one of the industry's largest selections of mounting solutions. A wide selection of mounting solutions, including wall, ceiling, desk, and floor mounts for display screens, dvLED, projectors, and audio equipment. B-Tech delivers versatility and choice for every setting.

### Decades of Excellence

Established in 1972, B-Tech brings over 50 years of industry experience and is a multiple award-winner, including Manufacturer of the Year at the AV Awards, and top honours for our System X and dvLED solutions.

### Rapid, Accurate Quotes

We offer quick, precise quotes for complex set-ups, including dvLED installations, often fulfilling bespoke needs directly from stock.

### Dedicated Support

Our technical and sales teams are always available to answer questions and provide expert guidance. Our engineers are available to design tailored installation plans and provide quotes based on your precise requirements.

### Fast Dispatch

Many of B-Tech's global locations offer same-day dispatch, ensuring swift delivery for urgent requirements.



**Fully stocked distribution centres**  
Enables a fast turn around on orders and shipping



**Full technical and sales support**  
From the point of enquiry through to installation

Worldwide Installations



Rental & Stage

Hospitality & Leisure

Exhibition & Conference

Showrooms

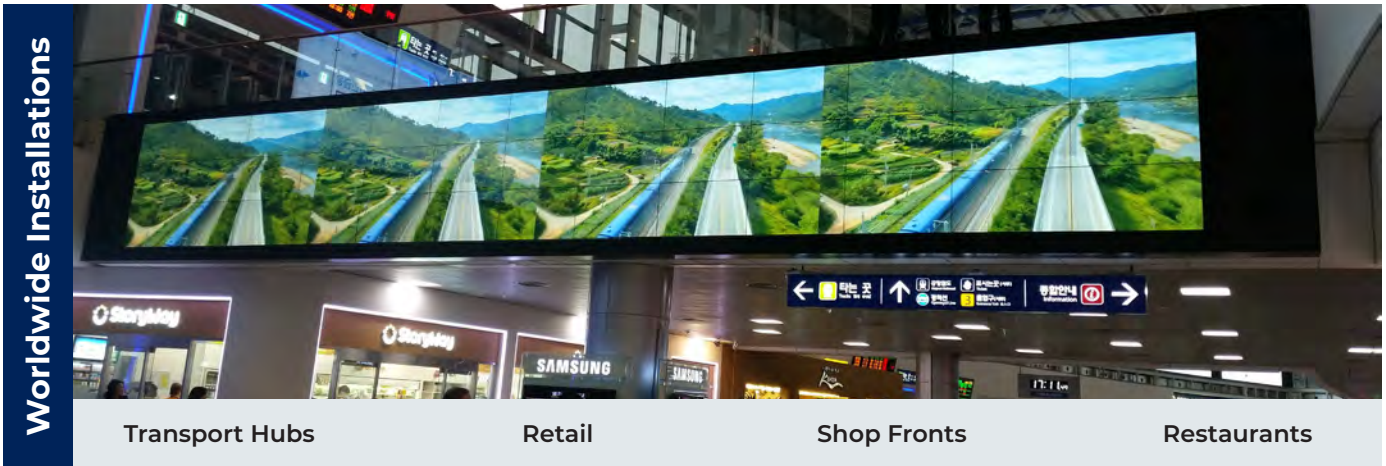

Worldwide Installations

Transport Hubs

Retail

Shop Fronts

Restaurants

## Limitless Configurations

With thousands of configurations available through our stocked, modular component systems, we provide versatile options for any project.

## Modular Design Systems

Our System X, System 2 ranges feature modular components that enable custom configurations, making installations exceptionally flexible and adaptable. This is especially valuable for complex or large-scale AV set-ups.

## In-House Design and Rigorous Testing

Our in-house engineering team ensures every product meets the highest standards of quality and innovation. Each item is tested to TÜV and UL standards, providing users with confidence in its reliability and performance.

## Installer Friendly

B-Tech mounts are designed with installation simplicity in mind, many features are included to save the installer on-site time with a streamlined mounting processes, pre-assembly of key components, rails cut to size in-house, complete technical drawings and installation guides provided.

## Innovative Design and Aesthetics

Our products merge functionality with style, offering professional-grade mounts that integrate seamlessly into both commercial and home environments without sacrificing visual appeal.



**Quick custom solutions.**  
Columns, rails and poles cut to length in-house



**Pre-assembly**  
To save valuable on-site installation time

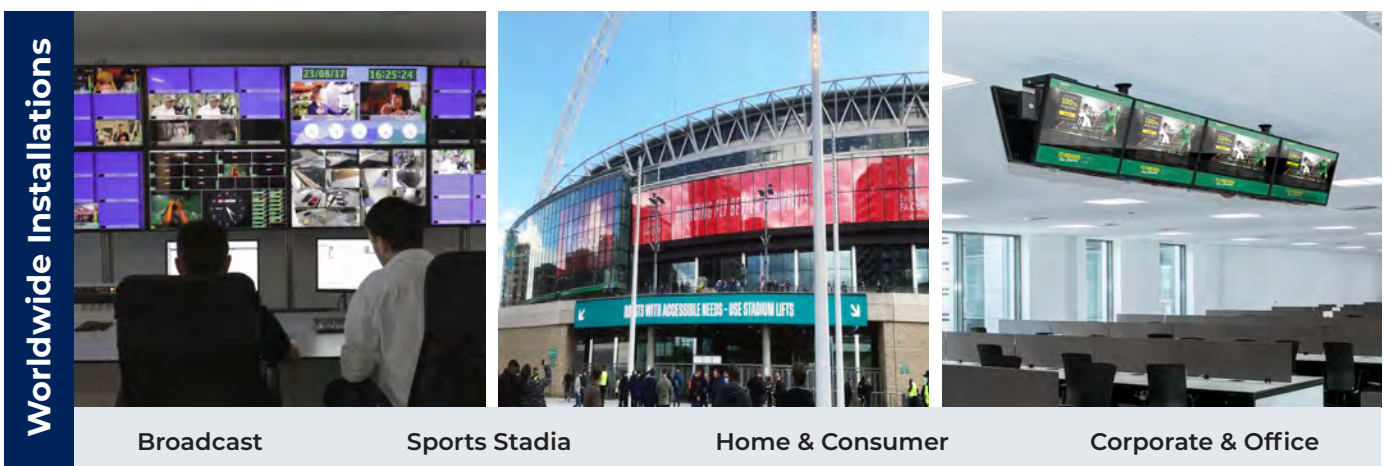

Worldwide Installations

Broadcast

Sports Stadia

Home & Consumer

Corporate & Office



B-Tech AV Mounts showrooms are an ideal venues for product training

## Design, Manufacturing and Safety Ethos

### In-House Design and Manufacturing

B-Tech's global product development department consists of designers and engineers working in unison from our European, Asian and North American offices. This wealth of experience enables B-Tech to produce quality solutions suitable for the international marketplace and provide a quick turnaround time on custom projects using first-hand knowledge of local markets and requirements. Installers are provided with full technical drawings, CAD images, installation guides, pre-assembled frames and rails cut to size for quick and easy on-site install.

### Custom Solutions

If you can't find what you're looking for from B-Tech's extensive range of off-the-shelf products, our technical support team will suggest using B-Tech component parts to create something new. If that's still not suitable, our product engineers can design a bespoke product based on your requirements to quickly develop and manufacture a custom solution.

### Design Safety

In-line with **TUV** and **UL** safety guidelines, B-Tech products are designed, engineered and tested to make sure they function correctly at the maximum stated load and do not fail at **5x** the maximum stated load. The highest quality materials are always used according to the requirements. At B-Tech, we design products that are, above all, safe, solid and secure.



Product development department consists of a global group of designers and engineers working in unison



Our testing facilities allow our engineers to validate all designs prior to production

### B-Tech Facilities Worldwide

The B-Tech AV Mounts group of companies is unique in the world of AV mounting solution providers.

Originally founded in the UK in 1972, today it is formed of multiple companies strategically located around the world, from which we are able to offer the full service expected of a leading global brand, with a familiar, local feel. Sales, technical support, full ranges of stock and next day shipment are all standard offerings you can expect from your local B-Tech company.



**UK.** Home of the original B-Tech AV Mounts office. Having been established in 1972, today our head office is located in **Daventry, Northamptonshire** in the centre of the UK for easy access to all of the **UK**.

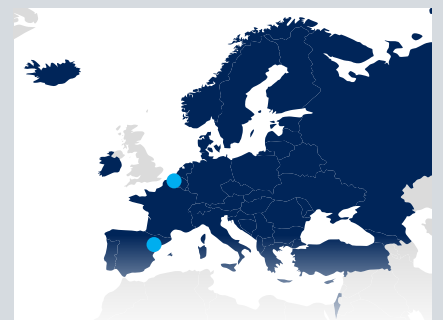

**EUROPE.** Our European HQ is located in **Brussels, Belgium** and supplies our satellite operation in **Spain** as well as other key European markets such as **France, Germany, Italy, the Nordics, Central and Eastern Europe**.





Complete technical drawings & installation guides provided

## The B-Tech Guarantee

### Warranty

Setting high standards and meeting customer expectations is our top priority. To support this, we offer our B-Tech guarantee..Most of B-Tech's products are available with a minimum 5-year guarantee as standard, and up to 10-years on many key products in the range. The guarantee is against defects in materials and quality, and we will replace or credit faulty goods. *The guarantee applies to the original owner only and must follow all installation guidelines.*

### Suppliers

At our manufacturing facilities, on-site engineers perform thorough product QC checks during and after production. Stringent quality control checks are carried out upon delivery to our warehouses. B-Tech products are compliant with European Regulations (EU) 2001/95/EC, 2023/988, REACH and RoHS directives and our major part suppliers hold ISO certifications. These manufacturing and production facilities undergo regular quality and ethical audits by B-Tech and third parties, such as SGS and ITS, conforming to international standards, guaranteeing the highest quality products.

### Sustainability

As part of our ethical responsibility strategy, B-Tech are committed to operating in an environmentally friendly way. A key element of this is to ship all new products with plastic-free packaging. We are also updating the boxes for all existing products and introducing this new-style packaging when we proceed with new production runs. Our goal is to eliminate plastic from our packaging across our entire range.



All quality control checks are performed by B-Tech engineers - no outsourcing

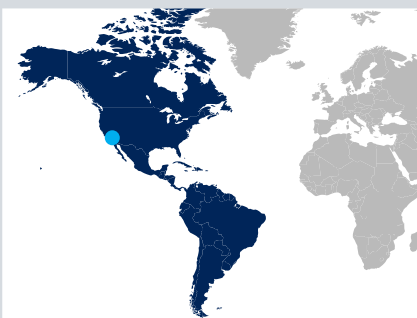

**NORTH AMERICA.** B-Tech AV Mounts North America is located in **Brea, California** and handles sales, distribution, marketing and product development for the North and South American markets.





**MEAI.** Our principal operation for the MEAI region is headquartered in **Dubai, UAE**. From there, B-Tech works closely with subsidiary partners in **India, South Africa** and **Egypt** to ensure service and supply to all MEAI markets.







**APAC** Multiple B-Tech operations throughout the region include offices in **China, Vietnam, Singapore** and **South Korea**. These offices handle all APAC sales and oversee the manufacturing and supply chain processes for the B-Tech group.

# Multi-Screen & Digital Signage Mounts Quick Reference Guide





## System X Menu Board Mounts

Wall	Wall	Ceiling	Ceiling
 <p><b>BT8330</b></p> <ul style="list-style-type: none"> <li>Max screen size: 75"</li> <li>Max load: 50kg per screen</li> <li>Mounting patterns: up to 900mm</li> </ul>	 <p><b>BT8331</b></p> <ul style="list-style-type: none"> <li>Max screen size: 75"</li> <li>Max load: 50kg per screen</li> <li>Mounting patterns: up to 900mm</li> </ul>	 <p><b>BT8332</b></p> <ul style="list-style-type: none"> <li>Max screen size: 75"</li> <li>Max load: 50kg per screen</li> <li>Mounting patterns: up to 900mm</li> </ul>	 <p><b>BT8333</b></p> <ul style="list-style-type: none"> <li>Max screen size: 75"</li> <li>Max load: 50kg per screen</li> <li>Mounting patterns: up to 900mm</li> </ul>
Page 36	Page 36	Page 36	Page 36

## System X Videowall Mounts

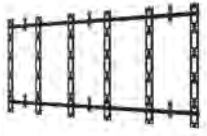
Wall	Wall	Ceiling	Ceiling
 <p><b>BT8340</b></p> <ul style="list-style-type: none"> <li>Max screen size: 75"</li> <li>Max load: 50kg per screen</li> <li>Mounting patterns: up to 900mm</li> </ul>	 <p><b>BT8341</b></p> <ul style="list-style-type: none"> <li>Max screen size: 75"</li> <li>Max load: 50kg per screen</li> <li>Mounting patterns: up to 900mm</li> </ul>	 <p><b>BT8342</b></p> <ul style="list-style-type: none"> <li>Max screen size: 75"</li> <li>Max load: 50kg per screen</li> <li>Mounting patterns: up to 900mm</li> </ul>	 <p><b>BT8343</b></p> <ul style="list-style-type: none"> <li>Max screen size: 75"</li> <li>Max load: 50kg per screen</li> <li>Mounting patterns: up to 900mm</li> </ul>
Page 37	Page 37	Page 37	Page 37

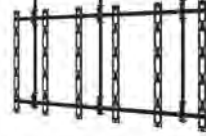
## System XPERT dvLED Mounts

Wall	Wall	Ceiling	Floor-To-Ceiling	Freestanding
 <p><b>BT9340</b></p> <ul style="list-style-type: none"> <li>BT9340-FM front mounted</li> <li>BT9340-RM rear mounted</li> </ul>	 <p><b>BT9343</b></p> <ul style="list-style-type: none"> <li>BT9343-FM front mounted</li> <li>BT9343-RM rear mounted</li> </ul>	 <p><b>BT9342</b></p> <ul style="list-style-type: none"> <li>BT9342-FM front mounted</li> <li>BT9342-RM rear mounted</li> </ul>	 <p><b>BT9344</b></p> <ul style="list-style-type: none"> <li>BT9344-FM front mounted</li> <li>BT9344-RM rear mounted</li> </ul>	 <p><b>BT9370</b></p> <ul style="list-style-type: none"> <li>BT9370-FM front mounted</li> <li>BT9370-RM rear mounted</li> </ul>
Page 22	Page 24	Page 22	Page 22	Page 23

## System XPRESS dvLED Mounts





Wall	Freestanding	Mobile	Bolt-Down	Ceiling	Floor-To-Ceiling
 <p><b>BT9240</b></p> <ul style="list-style-type: none"> <li>Kits: 4x4, 5x5, 6x6 &amp; 8x8</li> <li>Custom configuration available</li> </ul>	 <p><b>BT9270</b></p> <ul style="list-style-type: none"> <li>Kits: 4x4, 5x5, 6x6 &amp; 8x8</li> <li>Custom configuration available</li> </ul>	 <p><b>BT9271</b></p> <ul style="list-style-type: none"> <li>Kits: 4x4, 5x5, 6x6 &amp; 8x8</li> <li>Custom configuration available</li> </ul>	 <p><b>BT9272</b></p> <ul style="list-style-type: none"> <li>Kits: 4x4, 5x5, 6x6 &amp; 8x8</li> <li>Custom configuration available</li> </ul>	 <p><b>BT9242</b></p> <ul style="list-style-type: none"> <li>Custom configuration available</li> </ul>	 <p><b>BT9244</b></p> <ul style="list-style-type: none"> <li>Custom configuration available</li> </ul>
Page 30	Page 30	Page 30	Page 31	Page 31	Page 31

## XXL Digital Signage

Wall	Wall / Pop-Out	Wall / Pop-Out	Wall / Pop-Out	Wall / Pop-Out	Wall / Pop-Out
 <p><b>BT9920</b></p> <ul style="list-style-type: none"> <li>Max screen size: 120"</li> <li>Max load: 200kg</li> <li>Mounting patterns: up to 1600x800mm</li> </ul>	 <p><b>BT9923</b></p> <ul style="list-style-type: none"> <li>Max screen size: 120"</li> <li>Max load: 200kg</li> <li>Mounting patterns: up to 400x1500mm</li> </ul>	 <p><b>BT9921</b></p> <ul style="list-style-type: none"> <li>Max screen size: 120"</li> <li>Max load: 80kg</li> <li>Mounting patterns: up to 1600x800mm</li> </ul>	 <p><b>BT9922</b></p> <ul style="list-style-type: none"> <li>Max screen size: 136"</li> <li>Max load: 200kg</li> <li>Mounting patterns: up to 2400x1200mm</li> </ul>	 <p><b>BT9926</b></p> <ul style="list-style-type: none"> <li>Max screen size: 120"</li> <li>Max load: 200kg</li> <li>Mounting patterns: up to 1600x800mm</li> </ul>	 <p><b>BT9925</b></p> <ul style="list-style-type: none"> <li>Max screen size: 120"</li> <li>Max load: 80kg</li> <li>Mounting patterns: up to 800x1600mm</li> </ul>
Page 48	Page 49	Page 48	Page 48	Page 48	Page 48

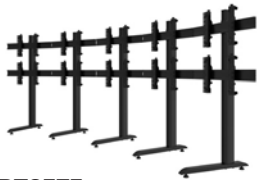









<b>System X Videowall Floor Stands</b>	<b>Freestanding</b>	<b>Mobile</b>	<b>Bolt-Down</b>	
				
	<b>BT8370</b> <ul style="list-style-type: none"> <li>Max screen size: 75"</li> <li>Max load: 50kg per screen</li> <li>Mounting patterns: up to 900mm</li> </ul>	<b>BT8371</b> <ul style="list-style-type: none"> <li>Max screen size: 75"</li> <li>Max load: 50kg per screen</li> <li>Mounting patterns: up to 900mm</li> </ul>	<b>BT8372</b> <ul style="list-style-type: none"> <li>Max screen size: 75"</li> <li>Max load: 50kg per screen</li> <li>Mounting patterns: up to 900mm</li> </ul>	<b>BT8377</b> <ul style="list-style-type: none"> <li>Max screen size: 75"</li> <li>Max load: 50kg per screen</li> <li>Mounting patterns: up to 900mm</li> </ul>
	Page 38	Page 38	Page 38	Page 38

<b>System X Curved Videowall Stands</b>	<b>Freestanding</b>		<b>Mobile</b>	<b>Bolt-Down</b>
	<b>Curved</b>	<b>Curved</b>	<b>Curved</b>	<b>Curved</b>
				
	<b>BT8373</b> <ul style="list-style-type: none"> <li>Max screen size: 75"</li> <li>Max load: 50kg per screen</li> <li>Mounting patterns: up to 900mm</li> </ul>	<b>BT8376</b> <ul style="list-style-type: none"> <li>Max screen size: 75"</li> <li>Max load: 50kg per screen</li> <li>Mounting patterns: up to 900mm</li> </ul>	<b>BT8374</b> <ul style="list-style-type: none"> <li>Max screen size: 75"</li> <li>Max load: 50kg per screen</li> <li>Mounting patterns: up to 900mm</li> </ul>	<b>BT8375</b> <ul style="list-style-type: none"> <li>Max screen size: 75"</li> <li>Max load: 50kg per screen</li> <li>Mounting patterns: up to 900mm</li> </ul>
Page 39	Page 39	Page 39	Page 39	



<b>Freestanding</b>	<b>Mobile</b>	<b>Bolt-Down</b>		
<b>Curved</b>		<b>Retractable Base</b>	<b>Curved</b>	
				
<b>BT9373</b> <ul style="list-style-type: none"> <li>BT9373-RM rear mounted</li> </ul>	<b>BT9371</b> <ul style="list-style-type: none"> <li>BT9371-FM front mounted</li> <li>BT9371-RM rear mounted</li> </ul>	<b>BT9372</b> <ul style="list-style-type: none"> <li>BT9372-FM front mounted</li> <li>BT9372-RM rear mounted</li> </ul>	<b>BT9377</b> <ul style="list-style-type: none"> <li>BT9377-FM front mounted</li> <li>BT9377-RM rear mounted</li> </ul>	<b>BT9375</b> <ul style="list-style-type: none"> <li>BT9375-RM rear mounted</li> </ul>
Page 24	Page 23	Page 23	Page 23	Page 24





<b>Full Service Mounts with Micro-Adjustment</b>	<b>Wall / Pop-Out</b>			
			<b>Slimline</b>	<b>XXL</b>
				
	<b>BT8309</b> <ul style="list-style-type: none"> <li>Max screen size: 42"</li> <li>Max load: 25kg</li> <li>Mounting patterns: up to 200x200</li> </ul>	<b>BT8301</b> <ul style="list-style-type: none"> <li>Max screen size: 70"</li> <li>Max load: 35g</li> <li>Mounting patterns: up to 600x400mm</li> </ul>	<b>BT8312</b> <ul style="list-style-type: none"> <li>Max screen size: 75"</li> <li>Max load: 50kg</li> <li>Mounting patterns: up to 600x400mm</li> </ul>	<b>BT8310XL</b> <ul style="list-style-type: none"> <li>Max screen size: 120"</li> <li>Max load: 125kg</li> <li>Mounting patterns: up to 600x400mm</li> </ul>
Page 45	Page 45	Page 44	Page 45	

<b>Digital Signage</b>	<b>Wall</b>	
	<b>Rotation</b>	<b>Portrait</b>
		
	<b>BT7550</b> <ul style="list-style-type: none"> <li>Max screen size: 65"</li> <li>Max load: 70kg</li> <li>Mounting patterns: up to 400x400</li> <li>Screen rotation: 90°</li> </ul>	<b>BT8322</b> <ul style="list-style-type: none"> <li>Max screen size: 65"</li> <li>Max load: 80kg</li> <li>Mounting patterns: up to 600x400mm</li> </ul>
Page 49	Page 49	







<b>Freestanding</b>	<b>Bolt-Down</b>				<b>Ceiling</b>
<b>Screen Enclosure</b>	<b>Screen Enclosure</b>	<b>Retractable Base Pole</b>	<b>Retractable Base Column</b>	<b>SAMSUNG OMN-D Series</b>	<b>SAMSUNG OMN-D Series</b>
					
<b>BT7003</b> <ul style="list-style-type: none"> <li>Max screen size: 65"</li> <li>Max load: 50kg</li> <li>Mounting patterns: up to 600x400mm</li> </ul>	<b>BT7004</b> <ul style="list-style-type: none"> <li>Max screen size: 65"</li> <li>Max load: 50kg</li> <li>Mounting patterns: up to 600x400mm</li> </ul>	<b>BT8577</b> <ul style="list-style-type: none"> <li>Max screen size: 75"</li> <li>Max load: 50kg</li> <li>Mounting patterns: up to 600x400mm</li> </ul>	<b>BT8587</b> <ul style="list-style-type: none"> <li>Max screen size: 86"</li> <li>Max load: 70kg</li> <li>Mounting patterns: up to 600x800mm</li> </ul>	<b>BT8326</b> <ul style="list-style-type: none"> <li>For use with: Samsung OMN-D Series</li> </ul>	<b>BT8325</b> <ul style="list-style-type: none"> <li>For use with: Samsung OMN-D Series</li> </ul>
Page 52	Page 52	Page 53	Page 53	Page 51	Page 51

# Trolleys / Floor Stands Quick Reference Guide

Trolleys	Mobile					
	 <p><b>BT7504</b></p> <ul style="list-style-type: none"> <li>Max screen size: 55"</li> <li>Max load: 25kg</li> <li>Mounting patterns: up to 400x400</li> </ul> <p>Page 77</p>	 <p><b>BT8503</b></p> <ul style="list-style-type: none"> <li>Max screen size: 60"</li> <li>Max load: 50kg</li> <li>Mounting patterns: up to 800x600mm</li> </ul> <p>Page 77</p>	 <p><b>BT8504</b></p> <ul style="list-style-type: none"> <li>Max screen size: 75"</li> <li>Max load: 70kg</li> <li>Mounting patterns: up to 600x400mm</li> </ul> <p>Page 77</p>	 <p><b>BT8562</b></p> <ul style="list-style-type: none"> <li>Max screen size: 75"</li> <li>Max load: 70kg</li> <li>Mounting patterns: up to 600x400mm</li> </ul> <p>Page 76</p>	 <p><b>BT8566</b></p> <ul style="list-style-type: none"> <li>Max screen size: 75"</li> <li>Max load: 70kg</li> <li>Mounting patterns: up to 600x400</li> <li>Screen rotation: 90°</li> </ul> <p>Page 76</p>	 <p><b>BT8564</b></p> <ul style="list-style-type: none"> <li>Max screen size: 120"</li> <li>Max load: 130kg</li> <li>Mounting patterns: up to 1000x600mm</li> </ul> <p>Page 76</p>



Floor Stands	Freestanding					
	 <p><b>BT8570</b></p> <ul style="list-style-type: none"> <li>Max screen size: 28"</li> <li>Max load: 8kg</li> <li>Mounting patterns: up to 100x100</li> </ul> <p>Page 82</p>	 <p><b>BT8571</b></p> <ul style="list-style-type: none"> <li>Max screen size: 47"</li> <li>Max load: 25kg</li> <li>Mounting patterns: up to 200x200</li> </ul> <p>Page 82</p>	 <p><b>BT8581</b></p> <ul style="list-style-type: none"> <li>Max screen size: 47"</li> <li>Max load: 35kg</li> <li>Mounting patterns: up to 200x200</li> </ul> <p>Page 82</p>	 <p><b>BT8572</b></p> <ul style="list-style-type: none"> <li>Max screen size: 55"</li> <li>Max load: 40kg</li> <li>Mounting patterns: up to 600x400mm</li> </ul> <p>Page 82</p>	 <p><b>BT8582</b></p> <ul style="list-style-type: none"> <li>Max screen size: 55"</li> <li>Max load: 40kg</li> <li>Mounting patterns: up to 600x400mm</li> </ul> <p>Page 82</p>	 <p><b>BT8573</b></p> <ul style="list-style-type: none"> <li>Max screen size: 75"</li> <li>Max load: 70kg</li> <li>Mounting patterns: up to 600x400mm</li> </ul> <p>Page 82</p>







Freestanding			Bolt-Down		
 <p><b>BT8705</b></p> <ul style="list-style-type: none"> <li>Max screen size: 75"</li> <li>Max load: 70kg</li> <li>Mounting patterns: up to 672x400mm</li> </ul> <p>Page 91</p>	 <p><b>BT8706</b></p> <ul style="list-style-type: none"> <li>Max screen size: 75"</li> <li>Max load: 70kg</li> <li>Mounting patterns: up to 672x400mm</li> </ul> <p>Page 91</p>	 <p><b>BT8709</b></p> <ul style="list-style-type: none"> <li>Max screen size: 100"</li> <li>Max load: 100kg</li> <li>Mounting patterns: up to 972x800mm</li> </ul> <p>Page 92</p>	 <p><b>BT8703</b></p> <ul style="list-style-type: none"> <li>Max screen size: 75"</li> <li>Max load: 70kg</li> <li>Mounting patterns: up to 672x400mm</li> </ul> <p>Page 91</p>	 <p><b>BT8704</b></p> <ul style="list-style-type: none"> <li>Max screen size: 75"</li> <li>Max load: 70kg</li> <li>Mounting patterns: up to 672x400mm</li> </ul> <p>Page 91</p>	 <p><b>BT8708</b></p> <ul style="list-style-type: none"> <li>Max screen size: 100"</li> <li>Max load: 140kg</li> <li>Mounting patterns: up to 972x800mm</li> </ul> <p>Page 92</p>







Twin Screen Video Conferencing	Floor-To-Wall	Bolt-Down		Freestanding		
	 <p><b>BT8710</b></p> <ul style="list-style-type: none"> <li>Max screen size: 65"</li> <li>Max load: 70kg per screen</li> <li>Mounting patterns: up to 600x400mm</li> </ul> <p>Page 92</p>	 <p><b>BT8711</b></p> <ul style="list-style-type: none"> <li>Max screen size: 65"</li> <li>Max load: 70kg per screen</li> <li>Mounting patterns: up to 600x400mm</li> </ul> <p>Page 93</p>	 <p><b>BT8538</b></p> <ul style="list-style-type: none"> <li>Max screen size: 86"</li> <li>Max load: 100kg per screen</li> <li>Mounting patterns: up to 1000x800mm</li> </ul> <p>Page 86</p>	 <p><b>BT8712</b></p> <ul style="list-style-type: none"> <li>Max screen size: 65"</li> <li>Max load: 56kg per screen</li> <li>Mounting patterns: up to 600x400mm</li> </ul> <p>Page 93</p>	 <p><b>BT8521</b></p> <ul style="list-style-type: none"> <li>Max screen size: 46"</li> <li>Max load: 20kg per screen</li> <li>Mounting patterns: up to 400x400mm</li> </ul> <p>Page 84</p>	 <p><b>BTF845</b></p> <ul style="list-style-type: none"> <li>Max screen size: 55"</li> <li>Max load: 25kg per screen</li> <li>Mounting patterns: up to 600x400mm</li> </ul> <p>Page 84</p>

# Trolleys / Floor Stands Quick Reference Guide























Mobile						
<p><b>XXL</b></p>  <p><b>BT8506</b></p> <ul style="list-style-type: none"> <li>Max screen size: 120"</li> <li>Max load: 130kg</li> <li>Mounting patterns: up to 1000x600mm</li> </ul> <p>Page 77</p>	<p><b>XXL</b></p>  <p><b>BT8590</b></p> <ul style="list-style-type: none"> <li>Max screen size: 120"</li> <li>Max load: 130kg</li> <li>Mounting patterns: up to 1600x800mm</li> </ul> <p>Page 79</p>	<p><b>XL</b></p>  <p><b>BT8545</b></p> <ul style="list-style-type: none"> <li>Max screen size: 86"</li> <li>Max load: 100kg</li> <li>Mounting patterns: up to 800x600mm</li> </ul> <p>Page 78</p>	<p><b>XXL</b></p>  <p><b>BT8546</b></p> <ul style="list-style-type: none"> <li>Max screen size: 110"</li> <li>Max load: 125kg</li> <li>Mounting patterns: up to 1000x800mm</li> </ul> <p>Page 78</p>	<p><b>XL Motorised</b></p>  <p><b>BT8558</b></p> <ul style="list-style-type: none"> <li>Max screen size: 100"</li> <li>Max load: 100kg</li> <li>Mounting patterns: up to 900x600mm</li> </ul> <p>Page 80</p>	<p><b>XL Motorised</b></p>  <p><b>BT8568</b></p> <ul style="list-style-type: none"> <li>Max screen size: 86"</li> <li>Max load: 100kg</li> <li>Mounting patterns: up to 1000x600mm</li> </ul> <p>Page 80</p>	<p><b>Low Level</b></p>  <p><b>BT8540</b></p> <ul style="list-style-type: none"> <li>Max screen size: 65"</li> <li>Max load: 70kg</li> <li>Mounting patterns: up to 600x400mm</li> <li>Tilt adjustment: 0°, 22.5°, 45°, 67.5°, 90°</li> </ul> <p>Page 79</p>

Freestanding					
 <p><b>BT8583</b></p> <ul style="list-style-type: none"> <li>Max screen size: 75"</li> <li>Max load: 70kg</li> <li>Mounting patterns: up to 600x400mm</li> </ul> <p>Page 82</p>	 <p><b>BTF840</b></p> <ul style="list-style-type: none"> <li>Max screen size: 75"</li> <li>Max load: 70kg</li> <li>Mounting patterns: up to 600x400mm</li> </ul> <p>Page 83</p>	<p><b>XL Portrait</b></p>  <p><b>BTF843</b></p> <ul style="list-style-type: none"> <li>Max screen size: 85"</li> <li>Max load: 70kg</li> <li>Mounting patterns: up to 800x600mm</li> </ul> <p>Page 83</p>	<p><b>Dual Stack Landscape</b></p>  <p><b>BTF841</b></p> <ul style="list-style-type: none"> <li>Max screen size: 65"</li> <li>Max load: 35kg per screen</li> <li>Mounting patterns: up to 600x400mm</li> </ul> <p>Page 84</p>	<p><b>Dual Stack Portrait</b></p>  <p><b>BTF842</b></p> <ul style="list-style-type: none"> <li>Max screen size: 65"</li> <li>Max load: 35kg per screen</li> <li>Mounting patterns: up to 600x400mm</li> </ul> <p>Page 84</p>	<p><b>Low Level</b></p>  <p><b>BT8541</b></p> <ul style="list-style-type: none"> <li>Max screen size: 65"</li> <li>Max load: 70kg</li> <li>Mounting patterns: up to 600x400mm</li> <li>Tilt adjustment: 0°, 22.5°, 45°, 67.5°, 90°</li> </ul> <p>Page 79</p>

















Floor-To-Wall Stands	Floor-To-Ceiling			Floor-To-Wall		
	 <p><b>BT8702</b></p> <ul style="list-style-type: none"> <li>Max screen size: 75"</li> <li>Max load: 70kg</li> <li>Mounting patterns: up to 672x400mm</li> </ul> <p>Page 90</p>	 <p><b>BT8700</b></p> <ul style="list-style-type: none"> <li>Max screen size: 75"</li> <li>Max load: 70kg</li> <li>Mounting patterns: up to 672x400mm</li> </ul> <p>Page 90</p>	 <p><b>BT8701</b></p> <ul style="list-style-type: none"> <li>Max screen size: 75"</li> <li>Max load: 70kg</li> <li>Mounting patterns: up to 672x400mm</li> </ul> <p>Page 90</p>	<p><b>XL</b></p>  <p><b>BT8707</b></p> <ul style="list-style-type: none"> <li>Max screen size: 100"</li> <li>Max load: 200kg</li> <li>Mounting patterns: up to 972x800mm</li> </ul> <p>Page 92</p>	<p><b>XL Motorised</b></p>  <p><b>BT8559</b></p> <ul style="list-style-type: none"> <li>Max screen size: 100"</li> <li>Max load: 100kg</li> <li>Mounting patterns: up to 900x600mm</li> </ul> <p>Page 80</p>	<p><b>XL Motorised</b></p>  <p><b>BT8569</b></p> <ul style="list-style-type: none"> <li>Max screen size: 86"</li> <li>Max load: 100kg</li> <li>Mounting patterns: up to 1000x600mm</li> </ul> <p>Page 81</p>

Mobile					Wall	
<p><b>VC Shelf</b></p>  <p><b>BT8511</b></p> <ul style="list-style-type: none"> <li>Max screen size: 46"</li> <li>Max load: 20kg per screen</li> <li>Mounting patterns: up to 400x400mm</li> </ul> <p>Page 85</p>	<p><b>VC Shelf</b></p>  <p><b>BT8514</b></p> <ul style="list-style-type: none"> <li>Max screen size: 46"</li> <li>Max load: 40kg per screen</li> <li>Mounting patterns: up to 400x400mm</li> </ul> <p>Page 85</p>	<p><b>VC Shelf</b></p>  <p><b>BT8516</b></p> <ul style="list-style-type: none"> <li>Max screen size: 65"</li> <li>Max load: 70kg per screen</li> <li>Mounting patterns: up to 600x400mm</li> </ul> <p>Page 85</p>	<p><b>VC Shelf</b></p>  <p><b>BT8517</b></p> <ul style="list-style-type: none"> <li>Max screen size: 75"</li> <li>Max load: 100kg per screen</li> <li>Mounting patterns: up to 600x800mm</li> </ul> <p>Page 86</p>	<p><b>VC Shelf XL</b></p>  <p><b>BT8518</b></p> <ul style="list-style-type: none"> <li>Max screen size: 86"</li> <li>Max load: 100kg per screen</li> <li>Mounting patterns: up to 1000x800mm</li> </ul> <p>Page 86</p>	<p><b>VC Shelf</b></p>  <p><b>BT8415</b></p> <ul style="list-style-type: none"> <li>Max screen size: 46"</li> <li>Max load: 70kg per screen</li> <li>Mounting patterns: up to 400x400mm</li> </ul> <p>Page 87</p>	<p><b>VC Shelf</b></p>  <p><b>BT8416</b></p> <ul style="list-style-type: none"> <li>Max screen size: 65"</li> <li>Max load: 70kg per screen</li> <li>Mounting patterns: up to 600x400mm</li> </ul> <p>Page 87</p>

# Flat Screen Wall Mounts Quick Reference Guide

<b>Small</b>	Fixed	Tilt	Tilt & Swivel	Single Arm	Double Arm
					
	<p><b>BT7510</b></p> <ul style="list-style-type: none"> <li>Max screen size: 28"</li> <li>Max load: 20kg</li> <li>Mounting patterns: 50x50, 75x75 &amp; 100x100</li> </ul>	<p><b>BT7511</b></p> <ul style="list-style-type: none"> <li>Max screen size: 28"</li> <li>Max load: 20kg</li> <li>Mounting patterns: 75x75 and 100x100</li> <li>Tilt: +17/-10°</li> </ul>	<p><b>BT7518</b></p> <ul style="list-style-type: none"> <li>Max screen size: 28"</li> <li>Max load: 20kg</li> <li>Mounting patterns: 75x75 and 100x100</li> <li>Tilt: +17/-10° • Swivel: 50°</li> <li>Screen rotation: 360°</li> </ul>	<p><b>BT7512</b></p> <ul style="list-style-type: none"> <li>Max screen size: 28"</li> <li>Max load: 15kg</li> <li>Mounting patterns: 75x75 and 100x100</li> <li>Tilt: +17/-10° • Swivel: 180°</li> <li>Distance from wall: 75 - 280mm</li> <li>Screen rotation: 360°</li> </ul>	<p><b>BT7513</b></p> <ul style="list-style-type: none"> <li>Max screen size: 28"</li> <li>Max load: 15kg</li> <li>Mounting patterns: 75x75 and 100x100</li> <li>Tilt: +17/-10° • Swivel: 180°</li> <li>Distance from wall: 95 - 467mm</li> <li>Screen rotation: 360°</li> </ul>
	Page 56	Page 56	Page 56	Page 56	Page 56
	Fixed		Tilt		Tilt & Swivel
					
<p><b>BT7532</b></p> <ul style="list-style-type: none"> <li>Max screen size: 47"</li> <li>Max load: 40kg</li> <li>Mounting patterns: 75x75, 100x100 and 200x200mm</li> </ul>	<p><b>BT8200</b></p> <ul style="list-style-type: none"> <li>Max screen size: 47"</li> <li>Max load: 40kg</li> <li>Mounting patterns: up to 240x200mm</li> </ul>	<p><b>BTV500</b></p> <ul style="list-style-type: none"> <li>Max screen size: 47"</li> <li>Max load: 40kg</li> <li>Mounting patterns: up to 225x200mm</li> </ul>	<p><b>BT7523</b></p> <ul style="list-style-type: none"> <li>Max screen size: 47"</li> <li>Max load: 25kg</li> <li>Mounting patterns: up to 200x200</li> <li>Tilt: +/-15°</li> </ul>	<p><b>BTV502</b></p> <ul style="list-style-type: none"> <li>Max screen size: 47"</li> <li>Max load: 25kg</li> <li>Mounting patterns: up to 200x200</li> <li>Tilt: +/-15° • Swivel: 180°</li> <li>Screen rotation: 360°</li> </ul>	
Page 58	Page 58	Page 58	Page 58	Page 58	
<b>Large</b>	Fixed			Tilt	
					
	<p><b>BT5441</b></p> <ul style="list-style-type: none"> <li>Max screen size: 65"</li> <li>Max load: 50kg</li> <li>Mounting patterns: up to 450x400mm</li> </ul>	<p><b>BTV510</b></p> <ul style="list-style-type: none"> <li>Max screen size: 55"</li> <li>Max load: 50kg</li> <li>Mounting patterns: up to 425x400mm</li> </ul>	<p><b>BT8441</b></p> <ul style="list-style-type: none"> <li>Max screen size: 65"</li> <li>Max load: 80kg</li> <li>Mounting patterns: up to 455x400mm</li> </ul>	<p><b>BT8431</b></p> <ul style="list-style-type: none"> <li>Max screen size: 65"</li> <li>Max load: 50kg</li> <li>Mounting patterns: up to 465x400mm</li> <li>Tilt: +/-15°</li> </ul>	
	Page 60	Page 60	Page 60	Page 60	
	Fixed			Tilt	
					
<p><b>BT5442</b></p> <ul style="list-style-type: none"> <li>Max screen size: 80"</li> <li>Max load: 70kg</li> <li>Mounting patterns: up to 650x400mm</li> </ul>	<p><b>BTV520</b></p> <ul style="list-style-type: none"> <li>Max screen size: 65"</li> <li>Max load: 70kg</li> <li>Mounting patterns: up to 825x500mm</li> </ul>	<p><b>BT8442</b></p> <ul style="list-style-type: none"> <li>Max screen size: 80"</li> <li>Max load: 80kg</li> <li>Mounting patterns: up to 655x400mm</li> </ul>	<p><b>BT8432</b></p> <ul style="list-style-type: none"> <li>Max screen size: 80"</li> <li>Max load: 70kg</li> <li>Mounting patterns: up to 677x400mm</li> <li>Tilt: +/-15°</li> </ul>		
Page 62	Page 62	Page 62	Page 62		
<b>X-Large</b>	Pull-Out	Double Arm		Fixed	
					
	<p><b>BT8443</b></p> <ul style="list-style-type: none"> <li>Max screen size: 75"</li> <li>Max load: 35kg</li> <li>Mounting patterns: up to 650x400mm</li> <li>Tilt: +10/-2° • Swivel: 28°</li> </ul>	<p><b>BT5227</b></p> <ul style="list-style-type: none"> <li>Max screen size: 75"</li> <li>Max load: 45kg</li> <li>Mounting patterns: up to 600x400mm</li> <li>Tilt: +12/-2° • Swivel: 180°</li> </ul>	<p><b>BT8227</b></p> <ul style="list-style-type: none"> <li>Max screen size: 75"</li> <li>Max load: 50kg</li> <li>Mounting patterns: up to 600x400mm</li> <li>Tilt: +14/-3° • Swivel: 180°</li> </ul>	<p><b>BT9901</b></p> <ul style="list-style-type: none"> <li>Max screen size: 100"</li> <li>Max load: 100kg</li> <li>Mounting patterns: up to 900x600mm</li> </ul>	
	Page 63	Page 63	Page 63	Page 64	

# Flat Screen Wall Mounts Quick Reference Guide

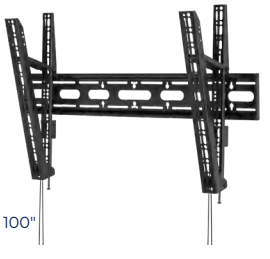
		Wall		Ceiling			
<b>Medical Mounts</b>		 <p><b>BT7592</b></p> <ul style="list-style-type: none"> <li>Max screen size: 28"</li> <li>Max load: 3-5kg</li> <li>Mounting patterns: 75x75 and 100x100</li> </ul> <p>Page 57</p>	 <p><b>BT7593</b></p> <ul style="list-style-type: none"> <li>Max screen size: 28"</li> <li>Max load: 5-8kg</li> <li>Mounting patterns: 75x75 and 100x100</li> </ul> <p>Page 57</p>	 <p><b>BT7594</b></p> <ul style="list-style-type: none"> <li>Max screen size: 28"</li> <li>Max load: 2kg-8kg</li> <li>Mounting patterns: 75x75 and 100x100</li> </ul> <p>Page 57</p>			
	<b>Single Arm</b>		<b>Double Arm</b>				
	 <p><b>BT7514</b></p> <ul style="list-style-type: none"> <li>Max screen size: 47"</li> <li>Max load: 25kg</li> <li>Mounting patterns: up to 200x200</li> <li>Tilt: +/-40° Swivel: 180°</li> <li>Distance from wall: 95 - 336mm</li> </ul> <p>Page 59</p>	 <p><b>BTV503</b></p> <ul style="list-style-type: none"> <li>Max screen size: 47"</li> <li>Max load: 25kg</li> <li>Mounting patterns: up to 200x200</li> <li>Tilt: +/-15° Swivel: 180°</li> <li>Distance from wall: 79 - 240mm</li> <li>Screen rotation: 360°</li> </ul> <p>Page 59</p>	 <p><b>BT7515</b></p> <ul style="list-style-type: none"> <li>Max screen size: 47"</li> <li>Max load: 25kg</li> <li>Mounting patterns: up to 200x200</li> <li>Tilt: +/-40° Swivel: 180°</li> <li>Distance from wall: 95 - 525mm</li> <li>Screen rotation: 360°</li> </ul> <p>Page 59</p>	 <p><b>BTV504</b></p> <ul style="list-style-type: none"> <li>Max screen size: 47"</li> <li>Max load: 25kg</li> <li>Mounting patterns: up to 200x200</li> <li>Tilt: +/-15° Swivel: 180°</li> <li>Distance from wall: 79 - 385mm</li> <li>Screen rotation: 360°</li> </ul> <p>Page 59</p>			
<b>Tilt</b>	<b>Double Arm</b>	<b>VESA Adaptors</b>				<b>Fixed</b>	
 <p><b>BT5431</b></p> <ul style="list-style-type: none"> <li>Max screen size: 65"</li> <li>Max load: 50kg</li> <li>Mounting patterns: up to 450x400mm</li> <li>Tilt: +15°</li> </ul> <p>Page 60</p>	 <p><b>BTV513</b></p> <ul style="list-style-type: none"> <li>Max screen size: 55"</li> <li>Max load: 35kg</li> <li>Mounting patterns: up to 400x400mm</li> <li>Tilt: +10/-2° Swivel: 180°</li> </ul> <p>Page 60</p>					 <p><b>BT7542</b></p> <ul style="list-style-type: none"> <li>Fits VESA patterns: 200x100 &amp; 200x200</li> </ul>	 <p><b>BT7540</b></p> <ul style="list-style-type: none"> <li>Fits VESA patterns: 300x200 &amp; 400x200</li> </ul>
<b>Tilt</b>	<b>Double Arm</b>	<b>Double Arm</b>					
 <p><b>BT5432</b></p> <ul style="list-style-type: none"> <li>Max screen size: 80"</li> <li>Max load: 70kg</li> <li>Mounting patterns: up to 650x400mm</li> <li>Tilt: +15°</li> </ul> <p>Page 62</p>	 <p><b>BT5226</b></p> <ul style="list-style-type: none"> <li>Max screen size: 65"</li> <li>Max load: 35kg</li> <li>Mounting patterns: up to 600x400mm</li> <li>Tilt: +12°/-2° Swivel: 180°</li> </ul> <p>Page 61</p>	 <p><b>BT8226</b></p> <ul style="list-style-type: none"> <li>Max screen size: 65"</li> <li>Max load: 35kg</li> <li>Mounting patterns: up to 600x400mm</li> <li>Tilt: +14°/-3° Swivel: 180°</li> </ul> <p>Page 61</p>	 <p><b>BT8229</b></p> <ul style="list-style-type: none"> <li>Max screen size: 65"</li> <li>Max load: 35kg</li> <li>Mounting patterns: up to 600x400mm</li> <li>Tilt: +14°/-3° Swivel: 180°</li> </ul> <p>Page 61</p>				
<b>XX-Large</b>	<b>Fixed</b>	<b>Tilt</b>	<b>Double Arm</b>				
	 <p><b>BT9903</b></p> <ul style="list-style-type: none"> <li>Max screen size: 120"</li> <li>Max load: 200kg</li> <li>Mounting patterns: up to 1000x600mm</li> </ul> <p>Page 64</p>	 <p><b>BT9910</b></p> <ul style="list-style-type: none"> <li>Max screen size: 100"</li> <li>Max load: 130kg</li> <li>Mounting patterns: up to 1000x600mm</li> <li>Tilt: +15°</li> </ul> <p>Page 64</p>	 <p><b>BT8228</b></p> <ul style="list-style-type: none"> <li>Max screen size: 120"</li> <li>Max load: 125kg</li> <li>Mounting patterns: up to 800x600mm</li> <li>Tilt: +15°/-3° Swivel: 130°</li> </ul> <p>Page 64</p>				

# Additional Mounting Solutions Quick Reference Guide

## Ceiling Mounts

### Swivel

- BT7553**
- Max screen size: 32"
  - Max load: 23kg
  - Mounting patterns: 75x75 and 100x100
  - Tilt: +90°/-15°
  - Swivel / Screen Rotation: 360°

Page 67

### Adjustable Drop

- BT8420**
- Max screen size: 47"
  - Max load: 25kg
  - Mounting patterns: up to 200x200
  - Tilt: +/- 40°

Page 67

- BT8424**
- Max screen size: 65"
  - Max load: 50kg
  - Mounting patterns: up to 600x400mm
  - Tilt: +/-15°

Page 67

### Adjustable Drop

- BT8426**
- Max screen size: 65"
  - Max load: 50kg
  - Mounting patterns: up to 600x400mm
  - Tilt: +/-15°

Page 68

## Security Mounts

### Dome Camera Mount

- BT5960**
- Max load: 5kg
  - Camera fixing dimensions: 51mm - 127.5mm

Page 160

### Dome Camera Mount

- BT5961**
- Max load: 5kg
  - Camera fixing dimensions: 51mm - 251.5mm

Page 160

### Dome Camera Mount

#### Screen Mount

- BT5962**
- Max screen size: 28"
  - Max screen load: 20kg
  - Mounting patterns: up to 100x100
  - Max camera load: 5kg
  - Camera fixing dimensions: 51mm - 127.5mm

Page 160

### Dome Camera Mount

#### Screen Mount

- BT5963**
- Max screen size: 28"
  - Max screen load: 20kg
  - Mounting patterns: up to 100x100
  - Screen tilt: +17°/-10°
  - Max camera load: 5kg
  - Camera fixing dimensions: 51mm - 127.5mm

Page 160

## Projector Mounts



- BT899**
- Max load: 25kg
  - Max fixing pattern: 370mm

Page 110

### Adjustable Drop



- BT899-AD**
- Max load: 25kg
  - Max fixing pattern: 370mm

Page 110



- BT899-FD**
- Max load: 25kg
  - Max fixing pattern: 370mm

Page 110

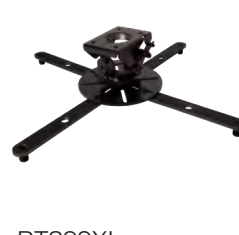

- BT899XL**
- Max load: 25kg
  - Max fixing pattern: 493mm

Page 110

### Adjustable Drop



- BT899XL-AD**
- Max load: 25kg
  - Max fixing pattern: 493mm

Page 110

## Desk Mounts



- BT7553**
- Max screen size: 32"
  - Max load: 23kg
  - Mounting patterns: 75x75 and 100x100
  - Tilt: +15°/-90°
  - Swivel: 360°
  - Screen Rotation: 360°

Page 71



- BT7351**
- Max screen size: 32"
  - Max load: 9kg
  - Mounting patterns: 75x75 and 100x100
  - Tilt: +60°/-60°
  - Swivel: 360°
  - Screen Rotation: 360°

Page 71



- BT7352**
- Max screen size: 32"
  - Max load: 9kg per screen
  - Mounting patterns: 75x75 and 100x100
  - Tilt: +60°/-60°
  - Swivel: 360°
  - Screen Rotation: 360°

Page 71

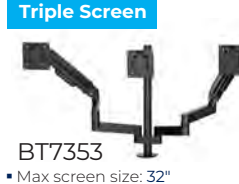

- BT7353**
- Max screen size: 32"
  - Max load: 9kg per screen
  - Mounting patterns: 75x75 and 100x100
  - Tilt: +60°/-60°
  - Swivel: 360°
  - Screen Rotation: 360°

Page 71



- BT7371**
- Max screen size: 32"
  - Max load: 9kg
  - Mounting patterns: 75x75 and 100x100
  - Tilt: +65°/-90°
  - Swivel: 360°
  - Screen Rotation: 360°

Page 72

## AV Storage Wall Mounts

### Slide-Out

#### AV Storage

- BT7883**
- Max screen size: 75"
  - Max screen weight: 70kg
  - Mounting patterns: 200x200mm up to 600x400mm

Page 98

### Pull-Down

#### AV Storage

- BT7885**
- Max screen size: 86"
  - Max screen weight: 70kg
  - Mounting patterns: 200x200mm up to 600x400mm

Page 98

### AV Storage

- BT7889**
- Max load: 10kg
  - Max AV equipment size: 450 x 280mm

Page 99

### Slide-Out

#### AV Storage

- BT7888**
- Max load: 10kg
  - Max AV equipment size: 450 x 250mm

Page 99

## Wall



# Additional Mounting Solutions Quick Reference Guide

## Ceiling

### Adjustable Drop

#### BT8427

- Max screen size: 75"
- Max load: 70kg
- Mounting patterns: up to 600x400mm
- Tilt: up to +20°



Page 68

### Back-To-Back

#### BT8428

- Max screen size: 65"
- Max load: 50kg per screen
- Mounting patterns: up to 600x400mm
- Tilt: +/-15°



Page 68

### XXL

#### BT8448

- Max screen size: 120"
- Max load: 130kg
- Mounting patterns: up to 1000x600mm



Page 69

### XXL

### Tilt

#### BT8449

- Max screen size: 100"
- Max load: 80kg
- Mounting patterns: up to 1000x600mm
- Tilt: +0°, 5°, 10°, 15°



Page 69

## Ceiling

### Dome Camera Mount

### Screen Mount

#### BT5964

- Max screen size: 47"
- Max screen load: 25kg
- Mounting patterns: up to 200x200
- Screen tilt: +/-15°
- Max camera load: 5kg
- Camera fixing dimensions: 51mm - 127.5mm



Page 160

### NPT Adaptor

#### BT5965

- Max load: 25kg



Page 160

### Screen Mount

#### BT5970

- Max screen size: 28"
- Max screen load: 20kg
- Mounting patterns: 50x50, 75x75 and 100x100



Page 161

### Screen Mount

#### BT5971

- Max screen size: 28"
- Max screen load: 20kg
- Tilt of screen: +17/-10°
- Mounting patterns: up to 100x100



Page 161

### Screen Mount

#### BT5972

- Max screen size: 47"
- Max screen load: 25kg
- Tilt of screen: +/-40°
- Mounting patterns: up to 200x200



Page 161

## Ceiling

#### BT899XL-FD

- Max load: 25kg
- Max fixing pattern: 493mm



Page 110

#### BT893

- Max load: 70kg
- Max fixing pattern: 873mm



Page 111

### Adjustable Drop

#### BT893-AD

- Max load: 70kg
- Max fixing pattern: 873mm



Page 111

#### BT893-FD

- Max load: 70kg
- Max fixing pattern: 873mm



Page 111

## Clamp and Grommet

#### BT7372

- Max screen size: 32"
- Max load: 9kg
- Mounting patterns: 75x75 and 100x100
- Tilt: +65°/-90°
- Swivel: 360°
- Screen Rotation: 360°



Page 72

#### BT7373

- Max screen size: 32"
- Max load: 9kg
- Mounting patterns: 75x75 and 100x100
- Tilt: +65°/-90°
- Swivel: 360°
- Screen Rotation: 360°



Page 72

### Twin Screen

#### BT7374

- Max screen size: 32"
- Max load: 9kg per screen
- Mounting patterns: 75x75 and 100x100
- Tilt: +65°/-90°
- Swivel / Rotation: 360°



Page 72

#### BT7383

- Max screen size: 32"
- Max load: 9kg
- Mounting patterns: 75x75 and 100x100
- Tilt: +65°/-90°
- Swivel / Rotation: 360°



Page 72

### Heavy Duty

#### BT7355

- Max screen size: 49"
- Max load: 20kg
- Mounting patterns: 75x75 and 100x100
- Tilt: +5°/-55°
- Swivel / Rotation: 360°



Page 73

#### BT7356

- Max screen size: 55"
- Max load: 20kg
- Mounting patterns: 75x75 and 100x100
- Tilt: +5°/-55°
- Swivel / Rotation: 180°



Page 73

## Wall

## AV Shelves



#### BT7563

- Max load: 1kg
- Dimensions: 235x120mm

Page 100



#### BT7033

- Max load: 7.5kg (single attachment) 15kg (double attachment)
- Dimensions: 300x300mm

Page 101



#### BT7032

- Max load: 15kg (single attachment) 25kg (double attachment)
- Dimensions: 500x380mm

Page 101

## Soundbar

## Speaker Mounts



#### BTV914

- Max load: 10kg
- Height adjustable: 250mm
- Lateral adjustable: 112mm

Page 103

## Wall

### Side-Clamping



#### BT77

- Max load: 25kg
- Tilt: +/-10°
- Swivel: 360°

Page 103

# dvLED Videowall Mounting Solutions



**Future Stores**

London, Oxford Street  
400sqm dvLED wall using **System Xpert**

## Discover the Ultimate dvLED Mounting Solutions by B-Tech AV Mounts

Over the past decade B-Tech AV Mounts has continuously expanded and refined one of the most comprehensive and versatile dvLED mounting systems on the market. Our award-winning solutions are trusted globally across a wide range of projects, from compact installations to large-scale, high-profile AV setups. Whatever the size or scope, we have the perfect solution for you.

**New for 2025**, we're excited to introduce three specialised ranges tailored to meet diverse requirements, offering unparalleled flexibility and convenience.

## New for 2025

3-ways to create your ideal dvLED solutions!

## SYSTEM XPERT



**System Xpert**, the installers choice, is a premium range of dvLED mounting solutions trusted for its quality, ease of use, adjustability and fast installation. It meets every need, from simple small format wall mounts to extra-large, curved, odd shaped or even ceiling setups. Configurations can be generated using our online configuration tool. For more ambitious projects, our expert engineers can assist with bespoke specifications via email at [technical@btechavmounts.com](mailto:technical@btechavmounts.com). The range includes detailed documentation, pre-assembled components and precision engineered Interface components for your specific application.

## SYSTEM XPRESS

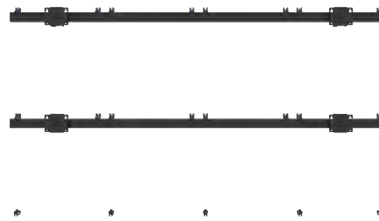

**System Xpress** revolutionises dvLED mounting supply with its innovative, universal design for self-locking cabinets. Featuring Patent Pending Xpress Connectors instead of screen-specific interface arms, this system offers unmatched versatility. The connectors click into your cabinets and lock effortlessly into supplied rails, enabling wall, floor, or ceiling installations with precision. Pre-configured in the most popular 16:9 layouts and stocked for immediate availability, System Xpress eliminates the need for custom fabrication, making it the fastest and easiest way to receive your dvLED mounting solution.

## Mounting solutions for ALL-IN-ONE DISPLAYS



Our **System AIO** range provides dedicated mounting solutions for the most popular all-in-one dvLED displays on the market. Offering wall-mounted, floor-standing, and mobile options, **System AIO** supports leading brands such as **Absen**, **LG**, and **Samsung**, ensuring a perfect fit for your display requirements.

# Making dvLED installation simple

To ensure the precise installation of dvLED cabinets, B-Tech provides a range of features in our dvLED solutions, including custom cut-to-size parts for every order. Our System X components are designed with level, depth, height, and angle adjustments, ensuring they meet diverse mounting requirements. These innovations make the installation of dvLED video walls straightforward, efficient, and highly adaptable to any set-up.



**Depth and Height Adjustment Brackets**  
Precision alignment on uneven surfaces



**Floor Base with Level Adjustment**  
Suitable for uneven floors



**Retractable Floor Base**  
Allows easy access to the front of AV displays  
*Ideal for shop window displays*



**All dvLED Solutions include Cut to Size parts**  
No on-site cuts required



**B-Tech's Service+** offers customers a fully integrated service tailored specifically for our System Xpert dvLED solutions.

**Our team of in-house engineers delivers:**

- Bespoke, installation-specific technical drawings.
- Pre-assembly of component parts for added convenience.
- Precision-cut rail lengths customised to your exact specifications - *a feature that sets us apart from competitor services.*

**Best of all, this service is provided free of charge for System Xpert Solutions.**

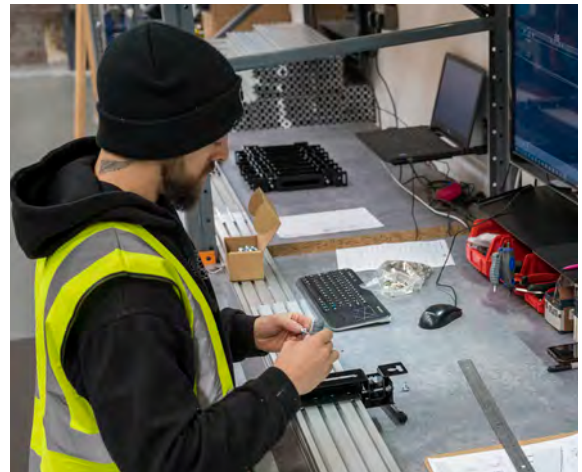

**Pre-assembly of component parts**



**Installation specific technical drawings**  
with all required dimensions for a straight forward assembly

**dvLED Mounting Solutions available for all major brands, including...**

<b>Abysen</b>	<b>dahua</b> TECHNOLOGY	<b>@lsee</b>	<b>AOTO</b>
<b>BARCO</b>	<b>BAUER</b> DIGITAL	<b>BOE</b>	<b>CHRISTIE</b>
<b>DAKTRONICS</b>	<b>digiLED</b>	<b>DELTA</b>	<b>DIGITAL PROJECTION</b>
<b>Esdumen</b> by LianTronics	<b>HandyLED™</b>	<b>HIKVISION</b>	<b>Hisense</b>
<b>INFILED</b>	<b>LANG</b>	<b>MAXHUB</b>	<b>Ledman</b>
<b>LEDstudio</b>	<b>LEYARD</b> EUROPE	<b>LG</b>	<b>LianTronics</b>
<b>Optoma</b>	<b>PHILIPS</b>	<b>PPDS</b>	<b>PixelFLEX</b>
<b>PLANAR</b>	<b>QSTECH</b>	<b>SAMSUNG</b>	<b>SiliconCore<sup>7</sup></b>
<b>SHARP/NEC</b>	<b>SONY</b>	<b>SNA DISPLAYS</b>	<b>VESTEL</b>

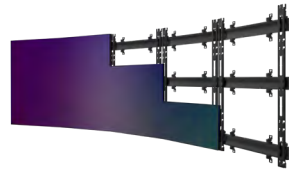



SYSTEM  
**XPERT**



SYSTEM  
**XPRESS**



**ALL-IN-ONE**  
DISPLAYS

Recommended Max configuration size	<b>Unlimited</b>	<b>10x10</b>	All-in-One
Production lead time (working days)	<b>25 days</b>	UK / EU: <b>0-2 days</b> Rest of the World: <b>4-8 days</b>	UK / EU: <b>0-2 days</b> Rest of the World: <b>4-8 days</b>
Universal compatibility	Designed and manufactured in accordance with the customer's cabinets	All 'latching' cabinets	Absen / LG / Samsung All-In-One displays
Function	Wall, Floor, Mobile, Bolt-Down, Ceiling Hung, Ceiling Flat, Curved, Bespoke	Wall, Floor, Mobile, Bolt-Down, Ceiling Hung	Wall, Floor, Mobile, Bolt-Down
Install time	<b>Fast</b>	<b>Medium</b>	<b>Fast</b>
Rear Mount	✓	✓	✗
Front Mount	✓	✗	✓
Micro-adjustment on wall plate	✓ Height & depth up to +/-10mm*	✓ Height & depth +/-5mm	✓ Height & depth +/-10mm
Height micro-adjustment on interface	✓ 20mm	✗	✓ 20mm
Depth adjustment	✓	✓	✓
Rails cut to size	✓	✓	✓
Pre-assembly with 	✓	✗	✗
Technical drawings provided by 	✓ Install specific drawings provided	✗ General installation guide with clear instructions provided for configurations outside of stocked packages ✓ Provided with stocked packages	✓ Provided with stocked packages
Indoor / Outdoor use	<b>Indoor &amp; Outdoor*</b>	<b>Indoor</b>	<b>Indoor</b>

\*Depending on application



Configure to your requirements using our online configurator, or contact [technical@btechavmounts.com](mailto:technical@btechavmounts.com) for more advanced set-ups.

*Examples of configurations are shown below; all configurations are available.*

■ **BT9340**  
**dvLED Wall Mount**  
for any configuration



**Depth and Height Adjustment Brackets**  
Precision alignment on uneven surfaces

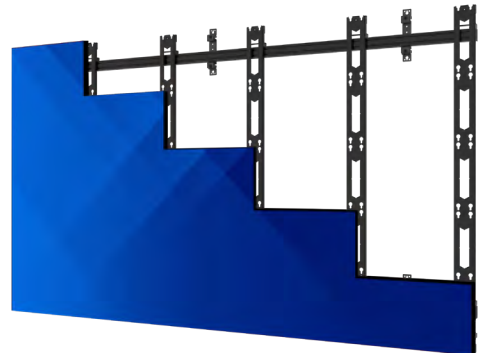

■ **BT9342**  
**dvLED Ceiling Mount**  
for any configuration



**Depth and Height Adjustment Brackets**  
Precision alignment for ceiling mounted solutions

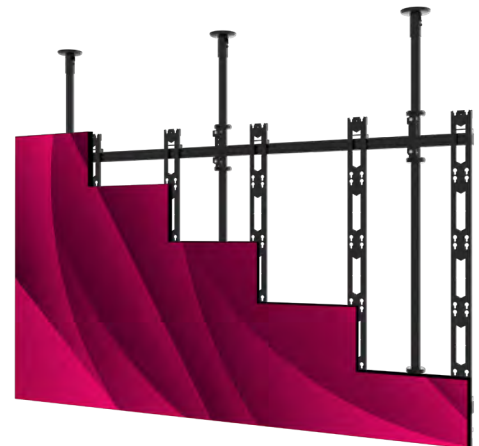

■ **BT9344**  
**dvLED Floor-To-Ceiling Mount**  
for any configuration



**Depth and Height Adjustment Brackets**  
Precision alignment for ceiling mounted solutions

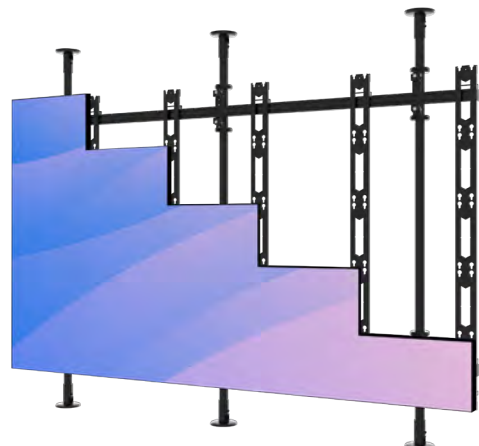

< > ↻ 🔍 [www.btechavmounts.com/led-panel-configurator](http://www.btechavmounts.com/led-panel-configurator) ☆ ☰



See page 26 for more information about our online configurator.

■ **BT9370**  
**dvLED Videowall Stand**  
for any configuration



■ **BT9371**  
**dvLED Mobile Stand**  
for any configuration



■ **BT9372**  
**dvLED Bolt-Down Stand**  
for any configuration



Optional **Adjustable Floor Base**  
with level adjustment for uneven floors

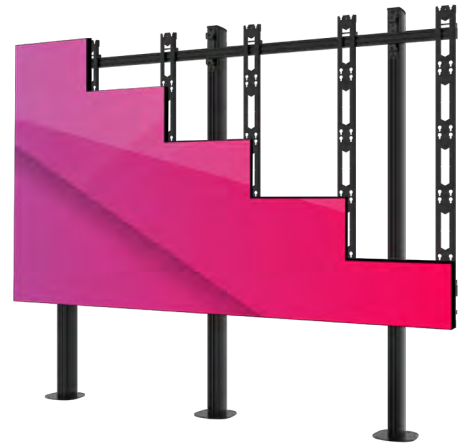

■ **BT9377**  
**dvLED Bolt-Down Stand with Retractable Base**  
for any configuration



**Retractable Floor Bases**  
Ideal for close to window installs





Configure to your requirements using our online configurator, or contact [technical@btechavmounts.com](mailto:technical@btechavmounts.com) for more advanced set-ups.

*Examples of configurations are shown below; all configurations are available.*

■ **BT9343**  
**dvLED Curved Wall Mount**  
for any configuration



**Depth and Height Adjustment Brackets**  
Precision alignment on uneven surfaces

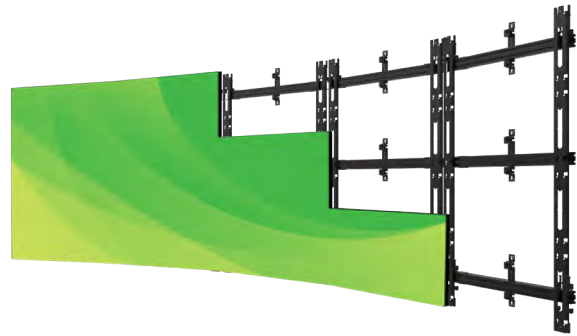

■ **BT9373**  
**dvLED Curved Stand**  
for any configuration



**Adjustable Levelling Feet**  
to allow for uneven floor surfaces



■ **BT9375**  
**dvLED Curved Bolt-Down Stand**  
for any configuration



Optional **Adjustable Floor Base**  
with level adjustment for uneven floors

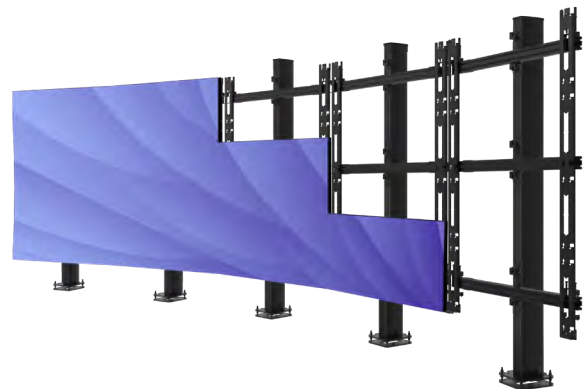

dvLED Curved mounts designed for Latching Curved Cabinets





See page 26 for more information about our online configurator.

■ **BT9376**  
dvLED **Curved Wave Bolt-Down Stand**  
for any configuration

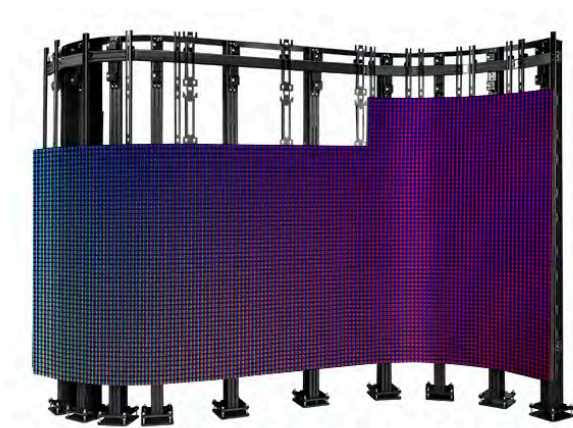

**Bolt Down Floor Bases**  
with level adjustment for uneven floors

■ **BT9350**  
**Internal dvLED Corner Wall Mount**

■ **BT9351**  
**External dvLED Corner Wall Mount**

■ **BT9352**  
**Cube dvLED Videowall Mount**

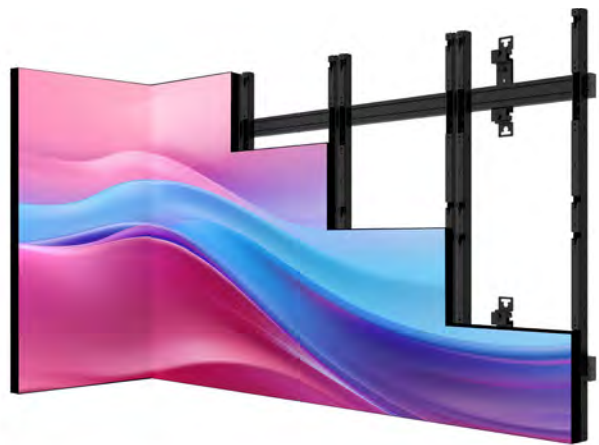

**Depth and Height Adjustment Brackets**  
Precision alignment on uneven surfaces

■ **BT9378**  
dvLED **Motorised Height Adjustable Mobile Stand**



# Direct View LED Videowall Online Configuration Tool

Step 1: Go to [www.btechavmounts.com](http://www.btechavmounts.com)



Step 2: Select Wall, Freestanding, Mobile or Bolt-Down

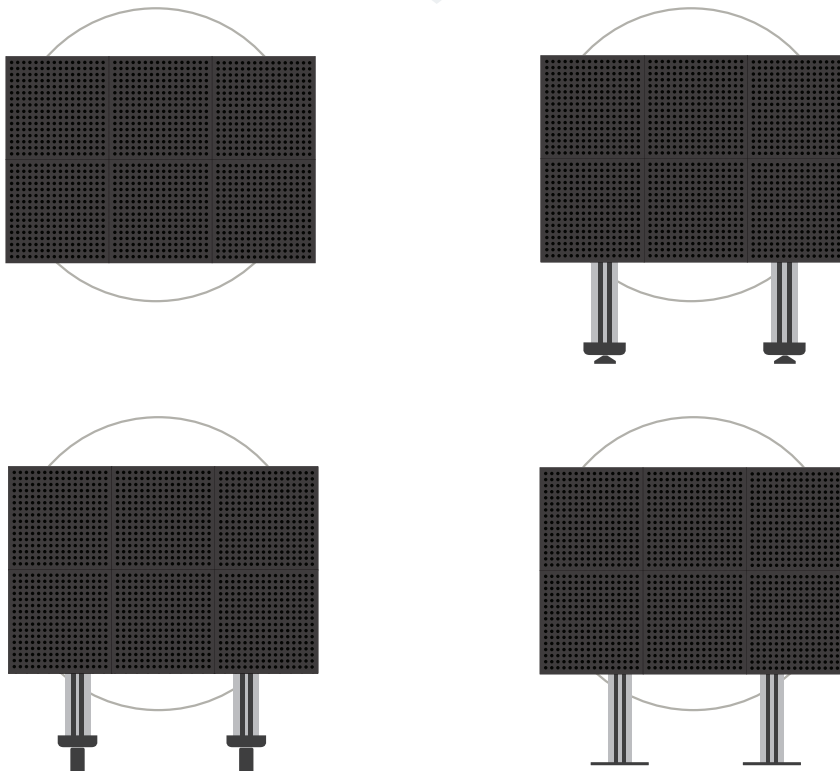

Configurations can be specified in just a few simple clicks. Start by choosing between wall or floor stand mounted options. Then, enter details about your screen size and the quantity to be installed, the orientation, the type and brand of dvLED panel to be used.

Once complete, fill out your contact details, and we'll get in touch and give you a quote for your requested configuration.

Floor Stands: Select **Mobile**, **Freestanding** or **Bolt-Down**

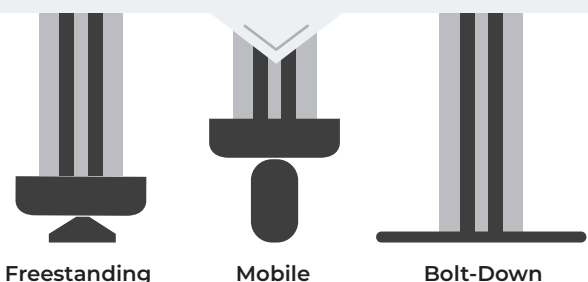

# For Wall, Freestanding, Mobile and Bolt-Down Mounting Solutions

## Step 3: Select specifications from drop down boxes

LED Cabinets Per Row	please select	▼	
Number of Rows of LED Cabinets	please select	▼	
Cabinet Dimensions	please select	▼	
Cabinet Weight	please select	▼	
Cabinet Brand / Model Number	please select	▼	
Cabinet Fixing Method	please select	▼	

## Step 4: Configure your LED Mounting Solution

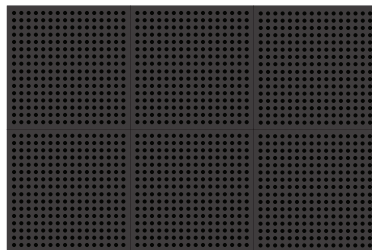

B-Tech Model:  
BT9340-3x2

## Step 5:

[Request a quote for this configuration](#)

## Alternatively: Contact B-Tech for Curved, Ceiling or Bespoke Solutions

To configure **curved**, **ceiling** or **bespoke** dvLED mounting solutions contact [technical@btechavmounts.com](mailto:technical@btechavmounts.com) stating your specifications to receive a quote within days.

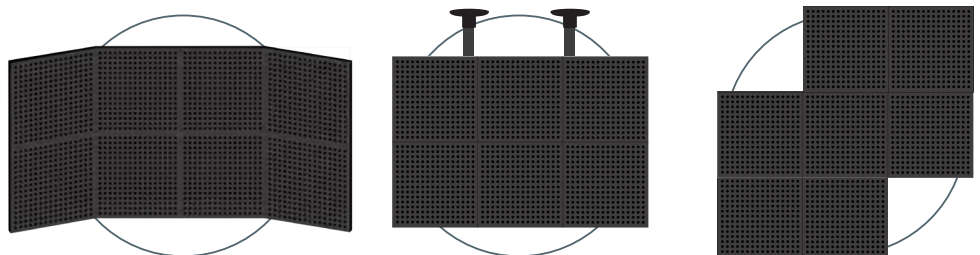

**System Xpress** offers a versatile range of universal dvLED mounting kits, ready for express shipment from stock. These kits can be ordered as pre-packaged solutions in configurations such as 4x4, 5x5, 6x6, and 8x8 or for other sizes and shapes, quoted and shipped using off-the-shelf components under a unique Bill of Materials for your specific project

Designed to mount interlocking 27" dvLED cabinets (Min. width 600 - Max.610mm), System Xpress features universal mounting connectors that eliminate the need for custom parts. This allows mounting solutions to be quoted, stocked, and shipped with speed and efficiency.

With same-day lead times for our ready-to-go kits and next day for everything else - that's what we call Xpress service!

*For custom configurations, cabinets other than 27" and bespoke solutions, see page 30.*

■ **BTXPS27-W**  
**Universal 27" dvLED Wall Mount**



Available in 4 pre-configured kits

<b>BTXPS27-W4X4</b>	4x4	Dimensions*: W. 2400-2440 x H. 1370 x D. 60mm
<b>BTXPS27-W5X5</b>	5x5	Dimensions*: W. 3000-3050 x H. 1710 x D. 60mm
<b>BTXPS27-W6X6</b>	6x6	Dimensions*: W. 3600-3660 x H. 2050 x D. 60mm
<b>BTXPS27-W8X8</b>	8x8	Dimensions*: W. 4800-4880 x H. 2740 x D. 60mm



■ **BTXPS27-S**  
**Universal 27" dvLED Stand**



Available in 4 pre-configured kits

<b>BTXPS27-S4X4</b>	4x4	Dimensions*: W. 2400-2440 x H. 2500 x D. 950mm
<b>BTXPS27-S5X5</b>	5x5	Dimensions*: W. 3000-3050 x H. 2500 x D. 950mm
<b>BTXPS27-S6X6</b>	6x6	Dimensions*: W. 3600-3660 x H. 2500 x D. 950mm
<b>BTXPS27-S8X8</b>	8x8	Dimensions*: W. 4800-4880 x H. 3100 x D. 950mm



## System Xpress Features

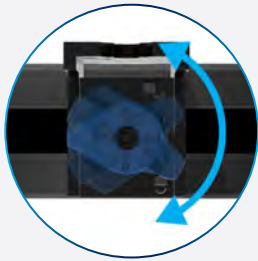

'Click & Lock' (patent pending) Interface Mounting Connector for a simple and secure installation

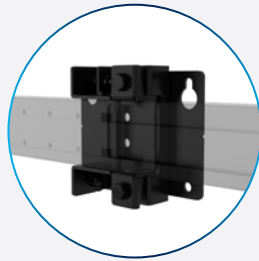

Depth Adjustable Rail Mounts



Bottom Row Spacer for Level Installation

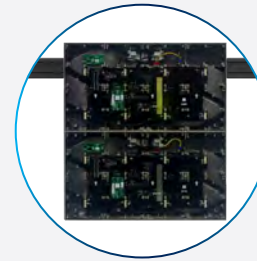

Designed for use with dvLED Locking Cabinets

### BTXPS27-B Universal 27" dvLED Bolt-Down Stand



Available in 4 pre-configured kits

BTXPS27-B4X4	4x4	Dimensions*: W: 2400-2440 x H: 2410 x D: 240mm
BTXPS27-B5X5	5x5	Dimensions*: W: 3000-3050 x H: 2410 x D: 240mm
BTXPS27-B6X6	6x6	Dimensions*: W: 3600-3660 x H: 2410 x D: 240mm
BTXPS27-B8X8	8x8	Dimensions*: W: 4800-4880 x H: 3010 x D: 240mm



### BTXPS27-M Universal 27" dvLED Mobile Stand



Available in 4 pre-configured kits

BTXPS27-M4X4	4x4	Dimensions*: W: 2400-2440 x H: 2620 x D: 950mm
BTXPS27-M5X5	5x5	Dimensions*: W: 3000-3050 x H: 2620 x D: 950mm
BTXPS27-M6X6	6x6	Dimensions*: W: 3600-3660 x H: 2620 x D: 950mm
BTXPS27-M8X8	8x8	Dimensions*: W: 4800-4880 x H: 3220 x D: 950mm



\*Product dimensions are based on mounting 600-610mm x 342mm cabinets.

For configurations beyond our off-the-shelf options, we offer custom **System Xpress** packages, recommended for up to 10x10 set-ups. For larger or more complex configurations, our System Xpert solutions have you covered.

Designed to support a wide range of interlocking dvLED cabinets of any size, System Xpress features universal mounting connectors that eliminate the need for custom parts. This allows mounting solutions to be quoted, stocked, and shipped with speed and efficiency.

With a production lead time of just two days for custom kits, that's what we call Xpress service!

*Examples of configurations are shown below; all configurations up to 10x10 are available under System Xpress.*

■ **BT9240**  
**Universal dvLED Wall Mount**  
for any configuration



■ **BT9270**  
**Universal dvLED Stand**  
for any configuration



**Adjustable Levelling Feet**  
to allow for uneven floor surfaces



■ **BT9271**  
**Universal dvLED Mobile Stand**  
for any configuration



**4" non-marking Braked Castors**  
for easy repositioning of the videowall



## System Xpress Features

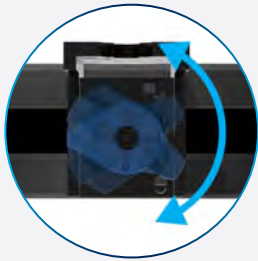

'Click & Lock'  
Interface Mounting Connector  
for a simple and secure installation

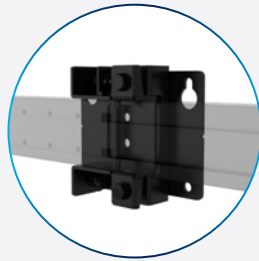

Depth Adjustable  
Rail Mounts



Bottom Row Spacer  
for Level Installation

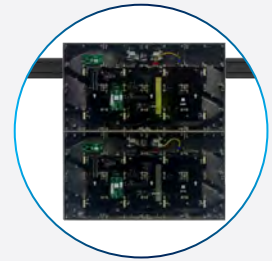

Designed for use  
with dvLED **Locking  
Cabinets**

### ■ BT9272 Universal dvLED **Bolt-Down Stand** for any configuration



Optional **Adjustable Floor Base**  
with level adjustment for uneven floors



### ■ BT9242 Universal dvLED **Ceiling Mount** for any configuration



### ■ BT9244 Universal dvLED **Floor-to-Ceiling Mount** for any configuration



Mounting solutions available for all major brands of All-in-One displays

# Absen

Mounting solutions designed specifically for Absens iCon series All-In-One LED Screens, the range consists of wall mounted, freestanding, mobile and bolt-down versions and all feature the same high-end aesthetic, anodised aluminium finish and integrated cable management, which ensures a smart and stylish installation.

Scan the QR code to view our exclusive to Absen Brochure.



# SAMSUNG

Designs specifically for Samsung's The Wall IAB 110", IAC 130" and IAB 146" All-In-One LED Screens, the range consists features freestanding and bolt down sdtands and all feature the same high-end aesthetic, anodised aluminium finish and integrated cable management, which ensures a smart and stylish installation. For a mobile stand add BT8380-CASTORS to a freestanding solution.

## ■ Freestanding Solutions

### **BT9370-SAM110**

Floor Stand for Samsung All-In-One 110" IAB Display

### **BT9370-SAM130**

Floor Stand for Samsung All-In-One 130" IAC Display

### **BT9370-SAM146**

Floor Stand for Samsung All-In-One 146" IAB Display



## ■ Bolt-Down Solutions

### **BT9372-SAM110**

Bolt-Down Stand for Samsung All-In-One 110" IAB Display

### **BT9372-SAM130**

Bolt-Down Floor Stand for Samsung All-In-One 130" IAC Display

### **BT9372-SAM146**

Bolt-Down Floor Stand for Samsung All-In-One 146" IAB Display



Scan the QR code to view our exclusive to Samsung Brochure.





Designs specifically for LG's LAEC015 136", LAEC018 163" and LAED015 171" All-In-One LED Screens, the range consists of wall mounted, freestanding, mobile and bolt-down versions and all feature the same high-end aesthetic, anodised aluminium finish and integrated cable management, which ensures a smart and stylish installation. *See page 42* for wall mounted solutions.



Scan the QR code to view our exclusive to LG Brochure.



## ■ Freestanding Solutions

### **BT83LAEC015-S**

Floor Stand for LG LAEC015 136" Display

### **BT83LG163-S**

Floor Stand for LG LAEC018 163" Display

### **BT83LG171-S**

Floor Stand for LG LAEC015 171" 21:9 Display



## ■ Mobile Solutions

### **BT83LAEC015-M**

Mobile Stand for LG LAEC015 136" Display

### **BT83LG163-M**

Mobile Stand for LG LAEC018 163" Display

### **BT83LG171-M**

Mobile Stand for LG LAEC015 171" 21:9 Display



## ■ Bolt-Down Solutions

### **BT83LAEC015-B**

Bolt-Down Stand for LG LAEC015 136" Display

### **BT83LG163-B**

Bolt-Down Stand for LG LAEC018 163" Display

### **BT83LG171-B**

Bolt-Down Stand for LG LAEC015 171" 21:9 Display



\*Wall mounts also available for the 136" BT83LAEC015 Display - *See page 48*

# SYSTEM X

## LCD Menu Board & Videowall Mounts



**B-Tech is the go-to multi-screen mounting systems provider, favoured by installers worldwide, thanks to a large selection of solutions that cover almost any requirement.**

Our modular mounting system for single-rail menu board and multi-rail video wall installations is suitable for screens of any size and can be configured for specific requirements using our System X component range. Mount multiple screens side-by-side with wall, ceiling, floor and curved solutions available.

Screens can be mounted in landscape or portrait orientation with interface options that include fixed, tilt, or pop-out arms with micro-adjustment, allowing for a precise alignment and a 'hassle-free' installation; perfect for fast food restaurants, transport hubs, entertainment venues, etc.

For complete product specifications, including technical drawings and colour options, scan the QR code for each product to view the online page.



### Alternative Configurations

There are thousands of System X mounting configurations available. Visit our online configuration tool to specify set-ups with options such as screen size, orientation and leg height available (See page 40 for more information).

**Try now at [www.btechavmounts.com/systemx-configurator](http://www.btechavmounts.com/systemx-configurator)**



CONFIGURE AS REQUIRED





## Key Features

- Configurable solution available to order to your requirements from stock products
- Choice of fixed, tilt, micro-adjustment or pop-out interface arms
- Multiple rail and pole lengths available - can be cut or joined to any length
- Micro-adjustment arms allow tool-less adjustments for seamless display alignment
- Full-service options available - Pop-Out arms for easy service access or recess mounting
- Suitable for landscape or portrait mounting
- Lateral adjustment available for post-installation screen alignment
- Curved options available
- Safety screws help prevent unauthorised removal of screens
- Simple installation with all mounting hardware included

**B-Tech's Menu Boards and Videowall solutions are ideal for Restaurants, Offices, Sports Arenas, Transport Hubs, Shop Fronts and many more...**

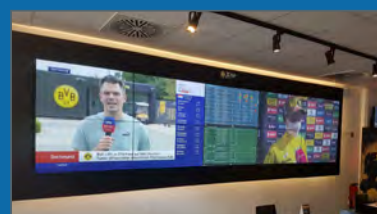



Single rail, multi-screen installations. Customise number of screens required (configuration shown in images for reference only).

### Choice Of Interface Arms



Choice Of Fixed (F), Tilt (T) or Micro-Adjustment (M) Interface Arms Available

### Rail Extension



Rails can be extended to any length. Customise rails to match the number of screens mounted

## BT8330 Menu Board Mounting System



Example X3 Screen Configuration

Recommended Max Screen	Max Load	Max VESA	QR Code
75" / 190cm	50kg per screen	900	

## BT8331 Pop-Out Menu Board Mounting System



Recommended Max Screen	Max Load	Max VESA	QR Code
75" / 190cm	50kg per screen	900	

## BT8332 Ceiling Mounted Menu Board Mounting System



Recommended Max Screen	Max Load	Max VESA	QR Code
75" / 190cm	50kg per screen	900	

## BT8333 Ceiling Mounted Curved Menu Board Mounting System



Recommended Max Screen	Max Load	Max VESA	QR Code
75" / 190cm	50kg per screen	900	

## Menu Board Mounting Systems

Model Number	Mount Type	Recommended Screen Size	Max Weight (Per Screen)	Max VESA*	Tilt Arms	Micro-Adjustment (Depth)	Micro-Adjustment (Height)	Angle Adjustment (Curve)	Distance From Wall**	Ceiling Drop***	Colour Options
BT8330	Wall	32"-75"	50kg	900	+20°	+/-10mm	+/-20mm	N/A	(F) 48mm (T) 58.4mm (M) 86mm	N/A	<input checked="" type="checkbox"/>
BT8331	Wall, Pop-Out	39"-75"	50kg	900	N/A	+/-10mm	+/-20mm	N/A	(Closed) 105.4mm (Open) 332mm	N/A	<input checked="" type="checkbox"/>
BT8332	Ceiling	32"-75"	50kg	900	+20°	+/-10mm	+/-20mm	N/A	N/A	0.5m up to 3m	<input checked="" type="checkbox"/>
BT8333	Ceiling	32"-75"	50kg	900	N/A	+/-10mm	+/-20mm	+45°	N/A	0.5m up to 3m	<input checked="" type="checkbox"/>

\*Refers to maximum vertical fixing dimension. Correctly sized interface arms and adaptors will be supplied as necessary to suit the mounting pattern you require.



Multi screen, multi-rail installations (configuration in images for reference only). Available as wall, floor or ceiling mounts.

## Pop-Out Arms for Service Access

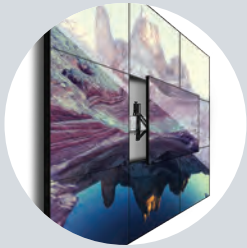

Pop-out interface arms available for full service access included as standard with BT8331 and BT8341

## Choice of Ceiling Drops



Multiple pole lengths available for ceiling mounting

### BT8340 Videowall Mounting System

Recommended Max Screen	Max Load	Max VESA	QR Code
75" / 190cm	50kg per screen	900	

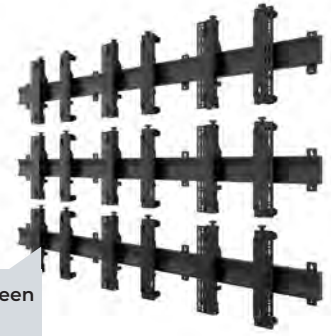

Example 3X3 Screen Configuration

### BT8341 Pop-Out Videowall Mounting System

Recommended Max Screen	Max Load	Max VESA	QR Code
75" / 190cm	50kg per screen	900	



### BT8342 Ceiling Mounted Videowall Mounting System

Recommended Max Screen	Max Load	Max VESA	QR Code
75" / 190cm	50kg per screen	900	



### BT8343 Ceiling Mounted Curved Videowall Mounting System

Recommended Max Screen	Max Load	Max VESA	QR Code
75" / 190cm	50kg per screen	900	



## Videowall Mounting Systems

Model Number	Mount Type	Recommended Screen Size	Max Weight (Per Screen)	Max VESA*	Tilt Arms**	Micro-Adjustment (Depth)	Micro-Adjustment (Height)	Angle Adjustment (Curve)	Distance From Wall	Ceiling Drop***	Colour Options
BT8340	Wall	32"-75"	50kg	900	+20°	+/-10mm	+/-20mm	N/A	(F) 48mm / (T) 58.4mm (M) 86mm	N/A	<input checked="" type="checkbox"/>
BT8341	Wall, Pop-Out	39"-75"	50kg	900	N/A	+/-10mm	+/-20mm	N/A	(Closed) 105.4mm (Open) 332mm	N/A	<input checked="" type="checkbox"/>
BT8342	Ceiling	32"-75"	50kg	900	+20°	+/-10mm	+/-20mm	N/A	N/A	0.5m up to 3m	<input checked="" type="checkbox"/>
BT8343	Ceiling	32"-75"	50kg	900	N/A	+/-10mm	+/-20mm	+45	N/A	0.5m up to 3m	<input checked="" type="checkbox"/>

\*\* Choice of Fixed (F), Tilt (T), or Micro-adjustment (M) interface arms, dependent on the type of installation required.

\*\*\* Rails and poles can be cut and joined to create any length required.



Multi-screen installations available as floor, wall or ceiling mounts from stock and ready to customise (configuration shown in images for reference only)

### Custom Set-Ups

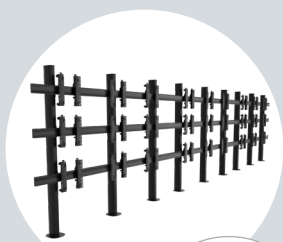

Use our online configuration to specify your requirements



### AV Accessory Component Shelves

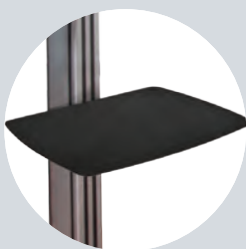

Fit AV Accessories such as shelves directly to columns

## BT8370 Videowall Stand

Recommended Max Screen	Max Load	Max VESA	QR Code
75" / 190cm	50kg per screen	900	

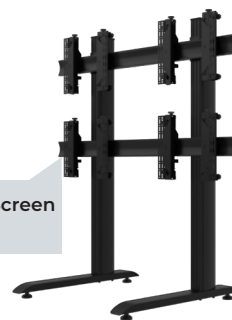

Example 2X2 Screen Configuration

## BT8371 Mobile Videowall Stand

Recommended Max Screen	Max Load	Max VESA	QR Code
75" / 190cm	50kg per screen	900	



## BT8372 Bolt-Down Videowall Stand

Recommended Max Screen	Max Load	Max VESA	QR Code
75" / 190cm	50kg per screen	900	

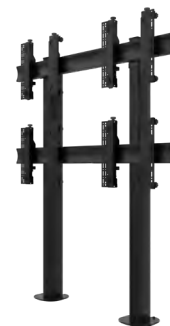

## BT8377 Bolt-Down Retractable Base Videowall Stand

Recommended Max Screen	Max Load	Max VESA	QR Code
75" / 190cm	50kg per screen	900	



## Videowall Stands

Model Number	Mount Type	Recommended Screen Size	Max Weight (Per Screen)	Max VESA*	Tilt Arms	Micro-Adjustment (Depth)	Micro-Adjustment (Height)	Angle Adjustment (Curve)	Max Height	Colour Options
BT8370	Freestanding	32"-75"	50kg	900	+20°	+/-10mm	+/-20mm	N/A	4.2m	<input checked="" type="checkbox"/>
BT8371	Mobile	32"-75"	50kg	900	+20°	+/-10mm	+/-20mm	N/A	3.6m	<input checked="" type="checkbox"/>
BT8372	Bolt-Down	32"-75"	50kg	900	+20°	+/-10mm	+/-20mm	N/A	4.2m	<input checked="" type="checkbox"/>
BT8377	Bolt-Down	32"-75"	50kg	900	+20°	+/-10mm	+/-20mm	N/A	2.4m	<input checked="" type="checkbox"/>

\*Refers to max. vertical fixing dimension for a typical configuration. Correctly sized interface arms and adaptors will be supplied as necessary to suit the mounting pattern you require.



Multi-screen curved installations. Available as floor, wall or ceiling mounts. Customise or choose off-the-shelf kits

## Adjustable Angle for Curved Displays



Integrated angle connector creates curved stands up to  $\pm 45^\circ$

## Cable Management



Integrated cable management featured for a tidy installation. Included on all System X stands

### BT8373 Curved Videowall Stand

Recommended Max Screen	Max Load	Max VESA	QR Code
75" 190cm	50kg per screen	900	

Example 2X5 Screen Configuration



### BT8374 Mobile Curved Videowall Stand

Recommended Max Screen	Max Load	Max VESA	QR Code
75" 190cm	50kg per screen	900	



### BT8375 Bolt-Down Curved Videowall Stand

Recommended Max Screen	Max Load	Max VESA	QR Code
75" 190cm	50kg per screen	900	

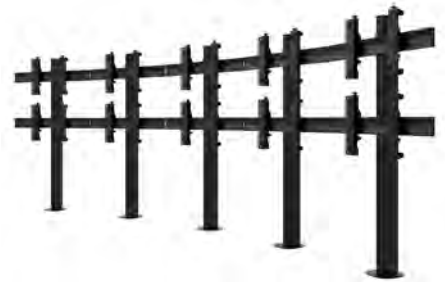

### BT8376 Freestanding Curved Videowall Stand

Recommended Max Screen	Max Load	Max VESA	QR Code
75" 190cm	50kg per screen	900	



## Curved Videowall Stands

Model Number	Mount Type	Recommended Screen Size	Max Weight (Per Screen)	Max VESA*	Tilt Arms	Micro-Adjustment (Depth)	Micro-Adjustment (Height)	Angle Adjustment (Curve)	Max Height	Colour Options
BT8373	Freestanding	32"-75"	50kg	900	N/A	+/-10mm	+/-20mm	+45°	4.2m	<input checked="" type="checkbox"/>
BT8374	Mobile	32"-75"	50kg	900	N/A	+/-10mm	+/-20mm	+45°	3.6m	<input checked="" type="checkbox"/>
BT8375	Bolt-Down	32"-75"	50kg	900	N/A	+/-10mm	+/-20mm	+45°	4.2m	<input checked="" type="checkbox"/>
BT8376	Freestanding	32"-75"	50kg	900	N/A	+/-10mm	+/-20mm	+45°	2.4m	<input checked="" type="checkbox"/>

# Menu Board & Videowall Online Configuration Tool

**Step 1:** Go to [www.btechavmounts.com](http://www.btechavmounts.com)



**Step 2:** Select Wall, Ceiling or Floor Mounted

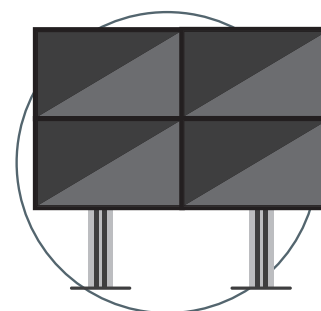
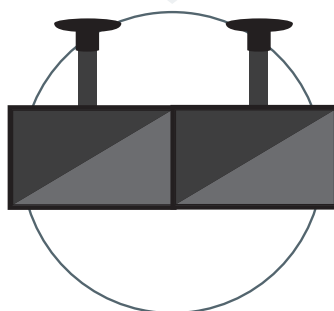
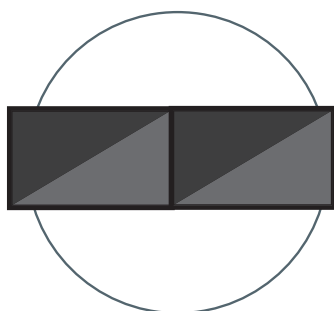

Configurations can be specified in just a few simple clicks. Start by choosing between wall or pole mounted options. Then, enter details about your screen size and the quantity to be installed, the orientation, the type of interface arm function such as tilt, fixed or micro-adjustment and pole length if required.

Once complete, fill out your contact details, and we'll get in touch and give you a quote for your requested configuration.

**Floor Stands:** Select **Mobile**, **Freestanding** or **Bolt-Down**



Freestanding



Mobile

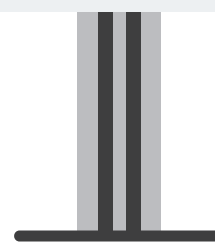

Bolt-Down

**Step 3:** Select specifications from drop down boxes

Screen Size	please select	▼
Screens Per Row	please select	▼
Column Height	please select	▼
Interface Function	please select	▼
Number Of Rows	please select	▼
Column Colour	please select	▼

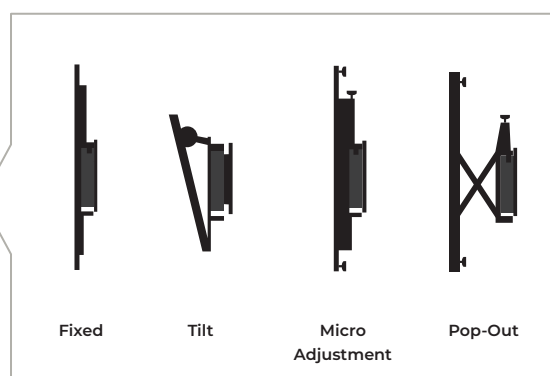

Fixed

Tilt

Micro Adjustment

Pop-Out



# For Wall, Ceiling & Floor Mounting Solutions

**Step 4:** Select Additional Options: Curved installation

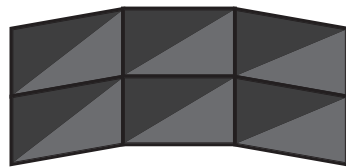

Add option for a curved display

**Step 5:** Select desired orientation (Landscape, Portrait)

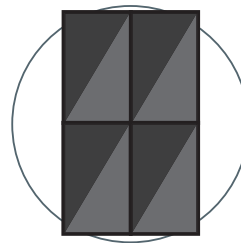
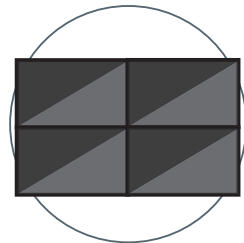

**Step 6:** Configure your mounting solution

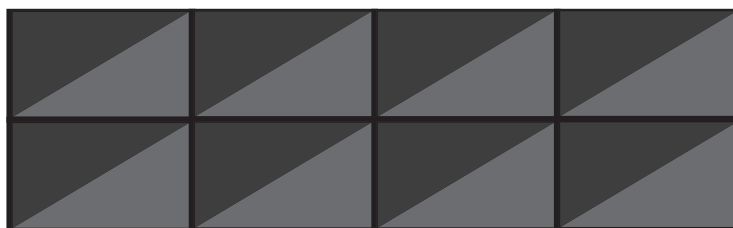

B-Tech Model:  
BT8340-WI4x2-42-F

**Step 7:**

Request a quote for this configuration

## System X Videowall mounting solutions

Available in 1,000s  
of configurations  
including Fixed,  
Tilt or Pop-Out



3x3



1x3

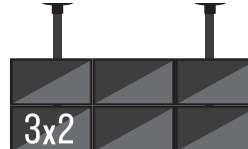

3x2

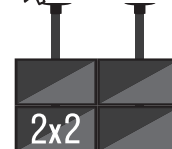

2x2



2x1

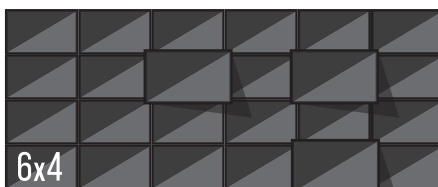

6x4

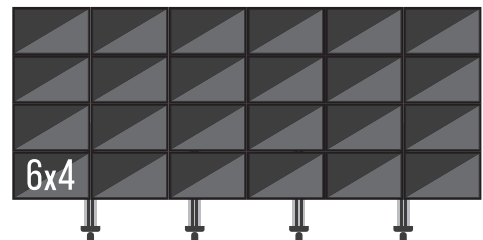

6x4

# Modular Videowall Mounts



**Designed to make videowall installations as quick and simple as possible, our range of modular mounting solutions can be used to create unlimited configurations in both landscape and portrait formats.**

Push-in, pop-out opening enables access to the rear of the mounted screen for servicing and maintenance and the low profile designs are ideal for multi-screen installations and mounting into walls with a shallow recess. Micro-adjustment knobs make screen alignment quick and easy.

For complete product specifications, including technical drawings, scan the QR code for each product to view the online page.

## Key Features

- Modular mounts allow videowall assembly in an unlimited number of configurations
- Suitable for landscape or portrait screen mounting
- Pop-out systems provide easy service access
- Tool-less micro-adjustment for seamless display alignment
- Depth, height and lateral adjustments of the screen
- Slim designs ideal for low-profile installs on walls or mounting in shallow recesses
- Keyhole mounting for quick and easy installation
- Suitable for pole mounting using System 2 collars
- Integrated locking mechanism prevents accidental pop-out of mount
- Safety screws help prevent unauthorised removal of screens
- Screen-specific spacer kits are available for the BT8312 to speed up installation times



### One mount per screen

Quick and easy to install, simple to configure and tailored specifically for videowall applications.



### Unlimited Configurations

Our modular mounting system allows videowall assembly in unlimited landscape or portrait configurations, from simple 2x2 videowalls to complex mosaic patterns.



### Pop-Out Recess Mounting

Easy pop-out, pop-in function for full-service access, ideal for mounting into a recess for a flush fit to the wall.





## BT8312 Features



8 Points of micro-adjustment for depth, height and lateral screen adjustment



Tool-less micro-adjustment of +/-7.5mm at each corner for seamless display alignment

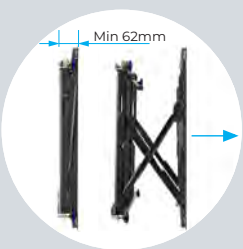

Slimline design mounts screen only 62mm from the wall and features unique soft opening providing a quick and easy service access



Keyhole mounting for an easy installation

## BT8312 Slimline Soft-Open Full Service Videowall Mount with 8-Point Micro-Adjustment



Recommended Max Screen	Max Load	Max VESA	QR Code
75" 190cm	50kg	600 x 400	

Patent Nos:  
GB2604327 | 17/588,521

Designed to make videowall installations as quick and simple as possible, this modular video wall mount can be used to create unlimited video wall configurations in both landscape and portrait formats. The BT8312 low-profile design is ideal for mounting into walls with a shallow recess or when space in front of the wall is minimal. 8 points of micro-adjustment make accurate screen alignment quick and easy and the soft opening features a patent pending controlled release, enabling access to the rear of the mounted screen for servicing and maintenance. Wall plate spacer kits are also available for the BT8312 to speed up the installation process.

### Example Setup:



428 screen installation

### ALSO AVAILABLE...

### Wall Plate Spacer Kits to aid quick installation

Screen Size	Screen Dimensions	Spacer Required
46"	1022 x 576mm	BT8312-SP461
46"	1025 x 579mm	BT8312-SP462
47"	1047 x 592mm	BT8312-SP471
49"	1078 x 608mm	BT8312-SP491
55"	1211 x 682mm	BT8312-SP552
55"	1215 x 686mm	BT8312-SP551
70"	1544 x 870mm	BT8312-SP701

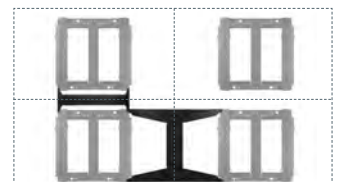

## Unlimited Configurations



Suitable for mosaic displays. Align and level screens using the built in micro-adjustment knobs

## Recess Mounting

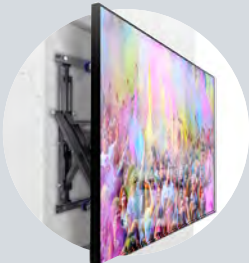

Pop-out design for full service access ideal for mounting into a shallow recess

## VESA Adaptors



Interface adaptor arms available to increase VESA fixings up to 900mm (See page 65)

### BT8309 Pop-Out Wall Mount with Micro-Adjustment



Recommended Max Screen	Max Load	Max VESA	QR Code
42" / 107cm	25kg	200	

### BT8301 Full Service Pop-Out Wall Mount with Micro-Adjustment



Recommended Max Screen	Max Load	Max VESA	QR Code
70" / 177cm	35kg	600 x 400	

### BT8310XL Heavy-Duty Pop-Out Wall Mount with Micro-Adjustment



Recommended Max Screen	Max Load	Max VESA	QR Code
120" / 305cm	125kg	600 x 400	

## Modular Full Service Videowall Mounts

Model Number	Recommended Screen Size	Max Weight	Max VESA	Universal Fixings	Micro-Adjustment (Depth)	Micro-Adjustment (Height)	Micro-Adjustment (Lateral)	Depth From Wall	Keyhole Fixings	Spacer Kit	Colour Options
BT8309	22" - 42"	25kg	200 x 200	200 x 100mm	+/-6mm	+12mm	<input checked="" type="checkbox"/>	73- 191mm*	<input checked="" type="checkbox"/>	N/A	N/A
BT8301	42" - 70"	35kg	600 x 400	442 x 436mm	+/-4mm	+/-13mm	N/A	77.5- 260mm**	<input checked="" type="checkbox"/>	N/A	N/A
BT8312	42" - 75"	50kg	600 x 400	400 x 400mm	+/-7.5mm	+15mm	<input checked="" type="checkbox"/>	69.5- 222.5mm**	<input checked="" type="checkbox"/>	<input checked="" type="checkbox"/>	N/A
BT8310XL	42" - 120"	125kg	600 x 400	400 x 400mm	+/-7mm	+15mm	<input checked="" type="checkbox"/>	101- 293mm**	<input checked="" type="checkbox"/>	<input checked="" type="checkbox"/>	N/A

\*Using the included interface adaptor arms to mount VESA 200 x 200 screens will increase the total depth of the product by 4mm  
 \*\*Using the included interface adaptor arms to mount VESA 600 x 400 screens will increase the total depth of the product by 6mm

■ Medium ■ Large ■ Extra Large

# Specialist Mounts and Digital Signage Solutions



**With more screens featuring in retail environments than ever before, the need for a comprehensive range of specialist mounting solutions is apparent.**

In addition to videowalls, single screens (ranging from small to XXL) and specialist signage, such as Samsung's double-sided OMN-D Series or LG's XXL 110" displays, are being installed into retail outlets. Our range of specialist mounting solutions includes various options catering to the applications often required: portrait mounts, pop-out options for recess mounting, rotational mounts for eye-catching displays and screen enclosures can also be customised to meet the installation requirements.

For complete product specifications, including technical drawings and colour options, scan the QR code for each product to view the online page.



### Angled Displays

Rotational mounts are ideal for creating creative, eye-catching installations, such as solutions that require mounting screens at fixed angles.

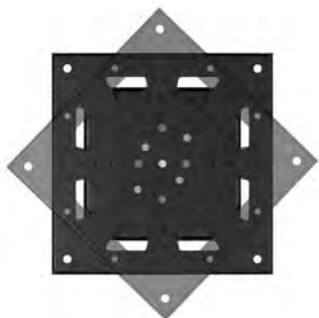

### XXL Signage Mounts

Ideal for the largest screens on the market such as LG's UHD Signage Displays.



### Digital Signage Mounts

Digital signage has become increasingly popular due to its ability to capture attention, convey information dynamically, and adapt to changing content needs.



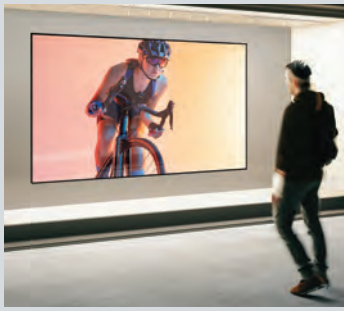

Wall mounts designed for XXL displays such as LG's 110UM5J

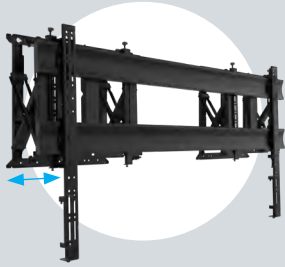

Pop-out, full service mounts are ideal for recessed walls



Landscape and portrait mounting options for XXL displays

**ALSO AVAILABLE...**

**BT8310XL**  
**Heavy Duty Pop-Out**  
**Flat Screen Wall Mount**  
 with Micro-Adjustment



See page 45 for more details

■ **BT9920**  
**Display Wall Mount**  
 for XXL Displays

Ideal for LG's 110" 110UM5J-B

Recommended Max Screen	Max Load	Max VESA	QR Code
120" 305cm	200kg	1600 x 800	



■ **BT9921**  
**Soft-Open Full Service Wall Mount**  
 for XXL Displays

Ideal for LG's 110" 110UM5J-B

Recommended Max Screen	Max Load	Max VESA	QR Code
120" 305cm	80kg	1600 x 800	

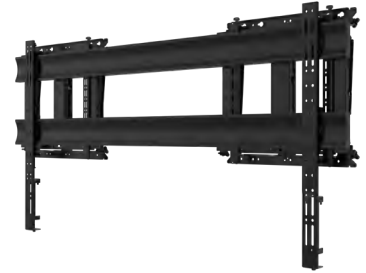

■ **BT9925**  
**Soft-Open Full Service Portrait Wall Mount**  
 for XXL Displays

Ideal for LG's 110" 110UM5J-B

Recommended Max Screen	Max Load	Max VESA	QR Code
120" 305cm	80kg	800 x 1600	



■ **BT9922**  
**Full Service Heavy Duty Wall Mount**  
 for XXL Displays

Ideal for LG's 136" LAEC015

Recommended Max Screen	Max Load	Max VESA	QR Code
136" 345cm	200kg	2400 x 1200	

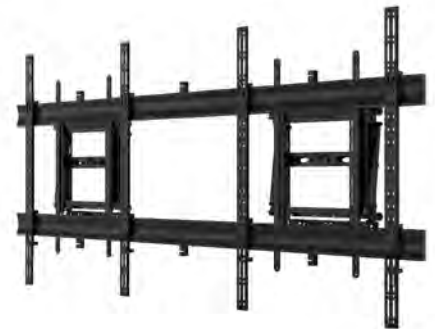

■ **BT9926**  
**Full Service Wall Mount**  
 for XXL Displays

Ideal for 21:9 Ultrawide screen displays

Recommended Max Screen	Max Load	Max VESA	QR Code
120" 305cm	200kg	1600 x 800	





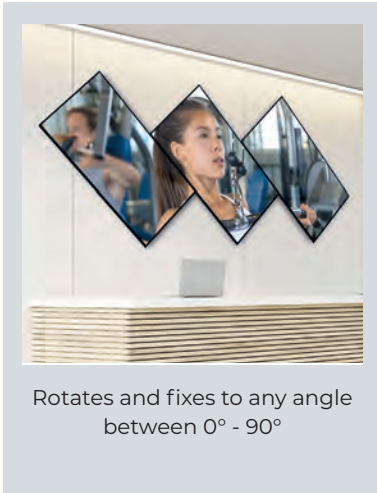

Rotates and fixes to any angle between 0° - 90°

## BT7550 Rotational Flip Mount for Large Screens

Allows mounted screens to rotate from landscape to portrait orientation or vice-versa



Angle guides help set the desired rotation of your screen

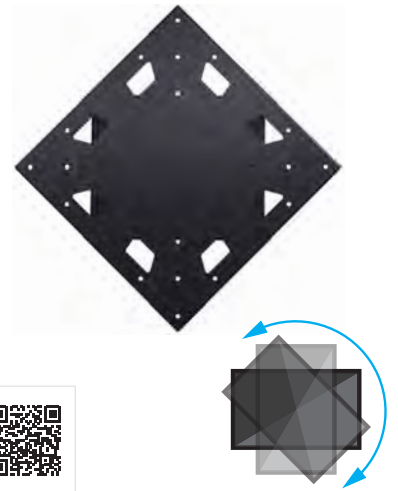

Recommended Max Screen	Max Load	Max VESA	Tilt	Rotation	QR Code
65" / 165cm	70kg	400	4.5°	90°	

## Portrait Wall Mount

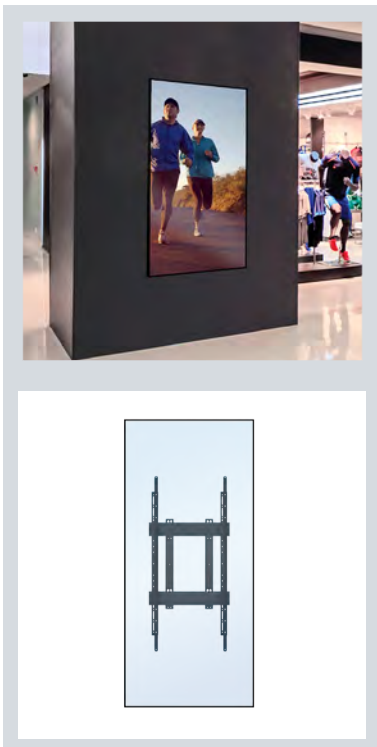

## BT8322 Portrait Digital Signage Wall Mount

Recommended Max Screen	Max Load	Max VESA	QR Code
65" / 165cm	80kg	400 x 600	



## BT9923 XXL Portrait Wall Mount for Ultrawide Displays

Ideal for 21:9 Ultrawide screen displays

Recommended Max Screen	Max Load	Max VESA	QR Code
120" / 305cm	200kg	600 x 1500	



## Specialist Wall Mounts

Model Number	Mount	Recommended Screen Size	Max Load	Max VESA	Tilt	Rotation	Lateral Shift	Distance From Wall	Landscape Mounting	Portrait Mounting
BT7550	Wall	37" - 65"	70kg	400	-4.5°	90°	N/A	47mm	<input checked="" type="checkbox"/>	<input checked="" type="checkbox"/>
BT8322	Wall	40" - 65"	80kg	400x600	N/A	N/A	<input checked="" type="checkbox"/>	36mm	N/A	<input checked="" type="checkbox"/>
BT9920	Wall	120"	200kg	1600x800	N/A	N/A	<input checked="" type="checkbox"/>	52mm	<input checked="" type="checkbox"/>	N/A
BT9921	Wall, Pop-Out	120"	80kg	1600x800	N/A	N/A	<input checked="" type="checkbox"/>	115mm - 268mm	<input checked="" type="checkbox"/>	N/A
BT9922	Wall, Pop-Out	120" - 136"	200kg	2400 x 1200	N/A	N/A	<input checked="" type="checkbox"/>	183mm - 375mm	<input checked="" type="checkbox"/>	N/A
BT9923	Wall	105" - 120"	200kg	600 x 1500	N/A	N/A	<input checked="" type="checkbox"/>	52mm	N/A	<input checked="" type="checkbox"/>
BT9925	Wall, Pop-Out	72" - 120"	80kg	800 x 1600	N/A	N/A	<input checked="" type="checkbox"/>	121mm - 268mm	N/A	<input checked="" type="checkbox"/>
BT9926	Wall, Pop-Out	72" - 120"	200kg	1600 x 800	N/A	N/A	<input checked="" type="checkbox"/>	146mm - 339mm	<input checked="" type="checkbox"/>	N/A



Digital signage kiosks are custom built to mount a single or back-to-back displays.

## ■ BT7000 Digital Signage Kiosk

Recommended Max Screen	Max Load	Max VESA	
86" 218cm	50kg	600 x 400	



Kiosks designed to be installed indoors, freestanding or bolted to the floor.

## ■ BT7001 Back-to-Back Digital Signage Kiosk

Recommended Max Screen	Max Load	Max VESA	
86" 218cm	50kg per screen	600 x 400	



Kiosks designed with heavy-duty bases, vented panels for airflow and feature internal storage space.

## ■ BT7002 Ultra-Slim Digital Signage Kiosk

Recommended Max Screen	Max Load	Max VESA	
86" 218cm	50kg	600 x 400	





**BT8326** designed specifically to floor mount: Samsung 55" OMN-D Series double-sided display panels

■ **BT8326**  
**Floor Mount**  
 for **SAMSUNG** OMN-D Series  
 Double Sided Display Panels

Recommended Max Screen	Max Load	
55" 140cm	50kg	



**BT8325** designed specifically to ceiling mount: Samsung 55" OMN-D Series double-sided display panels

■ **BT8325**  
**Ceiling Mount**  
 for **SAMSUNG** OMN-D Series  
 Double Sided Display Panels

Recommended Max Screen	Max Load	
55" 140cm	50kg	



## SYSTEM 2™



Allows extended ceiling drops using mounting components from the **System 2** range  
 (See page 132 for more information)

■ **BT8327**  
**System 2 Adaptor**  
 for use with BT8325

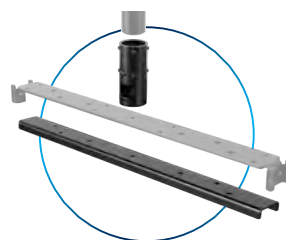



## ■ BT7003 Freestanding Digital Signage Mount with Screen Enclosure

Available in 3 screen sizes

BT7003-4350	43" - 50" Screens
BT7003-55	55" Screens
BT7003-65	65" Screens

Recommended Max Screen	Max Load	Max VESA	QR Code
65" 164cm	50kg	600 x 400	



## ■ BT7004 Bolt-Down Digital Signage Mount with Screen Enclosure

Available in 3 screen sizes

BT7004-4350	43" - 50" Screens
BT7004-55	55" Screens
BT7004-65	65" Screens

Recommended Max Screen	Max Load	Max VESA	QR Code
65" 165cm	50kg	600 x 400	



## ■ BT7104 Bolt-Down Twin Pole Digital Signage Mount with Screen Enclosure

**Customise:**  
Can be ordered for use  
with any B-Tech column / pole



Add BT7901 to any compatible mount/stand

## ■ BT7901 Screen Enclosure

Enclosure available in 3 screen sizes

BT7901-4350	43" - 50" Screens
BT7901-55	55" Screens
BT7901-65	65" Screens

Recommended Max Screen	Max Load	QR Code
65" 165cm	50kg	





**Retractable Floor Base**  
Allows easy access to the front of AV displays -  
Ideal for shop window displays



## ■ BT8577 Bolt-Down Pole Mounted Digital Signage Stand with Retractable Base

Recommended Max Screen	Max Load	Max VESA	QR Code
75" 190cm	40kg	600 x 400	



## ■ BT8587 Bolt-Down Column Mounted Digital Signage Stand with Retractable Base

Recommended Max Screen	Max Load	Max VESA	QR Code
86" 218cm	70kg	800 x 600	



## Specialist Stands for Digital Signage

Model Number	Mount	Recommended Screen Size	Max Screen Load	Max VESA	Tilt	Lateral Shift	Landscape Mounting	Portrait Mounting	System 2 & System X Compatible	Colour Options
BT7000	Freestanding	27" - 86"	50kg	600x400	N/A	✓	✓	✓	N/A	✓
BT7001	Freestanding	27" - 86"	50kg	600x400	N/A	✓	✓	✓	N/A	✓
BT7002	Freestanding	27" - 86"	50kg	600x400	N/A	✓	✓	✓	N/A	✓
BT8325	Ceiling	55"	50kg	N/A	N/A	N/A	N/A	✓	N/A	N/A
BT8326	Bolt-Down	55"	50kg	N/A	N/A	N/A	N/A	✓	N/A	N/A
BT7003	Freestanding	43" - 65"	50kg	600x400	N/A	✓	✓	✓	✓	✓
BT7004	Bolt-Down	43" - 65"	50kg	600x400	N/A	✓	✓	✓	✓	✓
BT8577	Bolt-Down	75"	40kg	600x400	N/A	✓	✓	✓	✓	N/A
BT8587	Bolt-Down	86"	70kg	600x800	N/A	✓	✓	✓	✓	✓

# Flat Screen Wall Mounts



**B-Tech's range of professional screen wall mounts is a comprehensive collection with various fixed, tilt and full motion solutions for screens ranging from 10" to 120".**

Many features can be found on products throughout the range, including designs for making installation as straightforward as possible. Additionally, many products are compatible with the B-Tech's System 2, System X and System V modular ranges using accessory collars, which allow them to be used for ceiling or other pole-mounted applications.

Please note, max screen sizes are recommendations only and it may be possible to mount other sizes; please refer to the screen's weight and mounting pattern to find the best compatible mount.

For complete product specifications, including technical drawings and colour options, scan the QR code for each product to view the online page.

**The VESA® Standard** mounting patterns are the distance (in millimetres) between the four mounting holes on the back of a screen and are used by most TV brands.





## Key Features

- Designed for an easy 1-2-3 step installation
- Mounts supplied pre-assembled
- Simple 'hook-on' screen mounting
- All mounting hardware included
- Suitable for landscape or portrait mounting
- Universal mounts feature lateral adjustment of the screen once mounted
- Brackets utilise various security features to prevent easy removal of the screen with safety screws or locking bar included
- Coverplates and cable management are included with swing arm mounts
- Wall brackets feature an 'On Wall Levelling System' (OWLS) or keyhole fixings for a hassle-free installation
- A large selection of mounts are compatible with System 2 and System X ranges suitable for both pole and column mounting

## elements

**B-Tech Elements** mounts offer the core traits that B-Tech is known for, exceptional build quality, strength, and reliability, without some of the premium features typically reserved for our flagship mounts.



## vantage

**B-Tech Vantage** mounts are premium articulating mounts with exceptional build quality, combining strength and versatility. Featuring **UltraGlide** technology allowing users to reposition displays effortlessly.





## Pole Mounting



Use accessory collars\* to pole mount compatible screen mounts. See table for System 2 compatibility  
\*Number of collars required dependent on the screen mount

## Space Savers

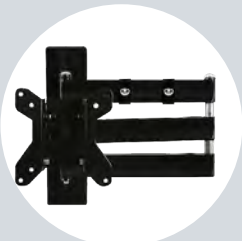

Swing-out arms fold flat to the wall

### BT7510 Ultra-Slim Wall Mount

Recommended Max Screen	Max Load	Max VESA	QR Code
28" / 71cm	20kg	100	



### BT7511 Wall Mount with Tilt

Recommended Max Screen	Max Load	Max VESA	Tilt	QR Code
28" / 71cm	20kg	100	10° / 17°	



### BT7518 Wall Mount with Tilt & Swivel

Recommended Max Screen	Max Load	Max VESA	Tilt	Swivel	Rotation	QR Code
28" / 71cm	20kg	100	10° / 17°	50°	360°	



### BT7512 Single Arm Wall Mount with Tilt & Swivel

Recommended Max Screen	Max Load	Max VESA	Tilt	Swivel	Rotation	QR Code
28" / 71cm	15kg	100	10° / 17°	180°	360°	



### BT7513 Double Arm Wall Mount with Tilt & Swivel

Recommended Max Screen	Max Load	Max VESA	Tilt	Swivel	Rotation	QR Code
28" / 71cm	15kg	100	10° / 17°	180°	360°	



## Flat Screen Wall Mounts - Small

Model Number	Function	Recommended Screen Size	Max Load	VESA	Tilt	Swivel	Rotation	Distance From Wall	Lateral Shift	On Wall Levelling (Owls)	System 2 Compatible
BT7510	Fixed	10" - 28"	20kg	50, 75, 100	N/A	N/A	N/A	15mm	N/A	<input checked="" type="checkbox"/>	<input checked="" type="checkbox"/>
BT7511	Tilt	10" - 28"	20kg	75, 100	+17°/-10°	N/A	N/A	55mm	N/A	<input checked="" type="checkbox"/>	<input checked="" type="checkbox"/>
BT7518	Tilt & Swivel	10" - 28"	20kg	75, 100	+17°/-10°	50°*	360°	93mm	N/A	<input checked="" type="checkbox"/>	<input checked="" type="checkbox"/>
BT7512	Single Arm	10" - 28"	15kg	75, 100	+17°/-10°	180°	360°	75 - 280mm	N/A	<input checked="" type="checkbox"/>	<input checked="" type="checkbox"/>
BT7513	Double Arm	10" - 28"	15kg	75, 100	+17°/-10°	180°	360°	95 - 467mm	N/A	<input checked="" type="checkbox"/>	<input checked="" type="checkbox"/>

\*Swivel increases to 180° when pole mounted



## Medical Mounts VESA 100



Anti-bacterial Powder Coating



Medical mounts manufactured with Interpon® anti-bacterial powder coating

### Easy Screen Positioning



Full motion, extendible mounts with handle for easy screen positioning

- BT7592**  
**Full Motion Articulating Arm Medical Wall Mount**  
 for screens from 3kg - 5kg



Recommended Max Screen	Max Load	Max VESA	Tilt	Swivel	QR Code
28" 71cm	5kg	100	100° 100°	360°	

- BT7593**  
**Full Motion Articulating Arm Medical Wall Mount**  
 for screens from 5kg - 8kg



Recommended Max Screen	Max Load	Max VESA	Tilt	Swivel	QR Code
28" 71cm	8kg	100	100° 100°	360°	

- BT7594**  
**Full Motion Articulating Arm Medical Ceiling Mount**  
 for screens from 2kg - 8kg



Recommended Max Screen	Max Load	Max VESA	Tilt	Swivel	QR Code
28" 71cm	8kg	100	10° 40°	330°	

## Specialist Flat Screen Wall Mounts

Model Number	Mount	Recommended Screen Size	Max Load	VESA	Tilt	Swivel	Screen Rotation	Extension	Lateral Shift	Height Adjustment	Anti-bacterial Powder Coating
BT7592	Wall	10" - 28"	3 - 5kg	75,100	+100°/-100°	360°	N/A	1650mm	N/A	<input checked="" type="checkbox"/>	<input checked="" type="checkbox"/>
BT7593	Wall	10" - 28"	5 - 8kg	75,100	+100°/-100°	360°	N/A	1650mm	N/A	<input checked="" type="checkbox"/>	<input checked="" type="checkbox"/>
BT7594	Ceiling	10" - 28"	2 - 8kg	75,100	+10°/-40°	330°	N/A	1895mm	N/A	<input checked="" type="checkbox"/>	<input checked="" type="checkbox"/>



## Low Profile Designs

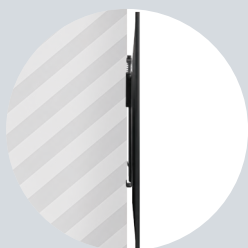

Ultra-Slim mounts for a close to the wall installation

## Compatibility with B-Tech Component Ranges

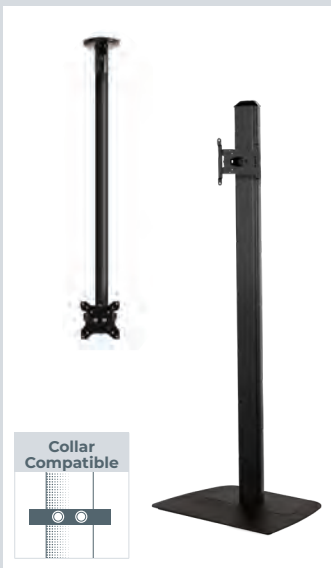

Many of the wall mounts featured in this catalogue are compatible with System 2 accessory collars for pole mounting or can be fitted directly onto System X columns. Check the specification table for each product for mount compatibility.

### ■ BT7532 Ultra-Slim Fixed Wall Mount



Recommended Max Screen	Max Load	Max VESA	QR Code
47" / 120cm	40kg	200	

### ■ BT8200 Ultra-Slim Fixed Wall Mount



Recommended Max Screen	Max Load	Max VESA	QR Code
47" / 120cm	40kg	200	

### ■ BTV500 Fixed Wall Mount



Recommended Max Screen	Max Load	Max VESA	QR Code
47" / 120cm	40kg	200	

### ■ BT7523 Wall Mount with Tilt



Recommended Max Screen	Max Load	Max VESA	Tilt	QR Code
47" / 120cm	40kg	200	15° / 15°	

### ■ BTV502 Wall Mount with Tilt & Swivel



Recommended Max Screen	Max Load	Max VESA	Tilt	Swivel	Rotation	QR Code
47" / 120cm	25kg	200	15° / 15°	180°	360°	



## ■ BTV503 Single Arm Wall Mount with Tilt & Swivel

Recommended Max Screen	Max Load	Max VESA	Tilt	Swivel	Rotation	QR Code
47" 120cm	25kg	200	15° 15°	180°	360°	



BT7514 supplied with alternative short arm

## ■ BT7514 Single Arm Wall Mount with Tilt & Swivel

Recommended Max Screen	Max Load	Max VESA	Tilt	Swivel	QR Code
47" 120cm	25kg	200	40° 40°	180°	

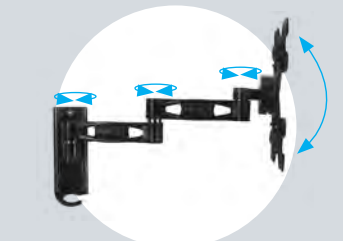

Swing arms swivel at 3 pivot points (wall, arm and interface)

## ■ BTV504 Double Arm Wall Mount with Tilt & Swivel

Recommended Max Screen	Max Load	Max VESA	Tilt	Swivel	Rotation	QR Code
47" 120cm	25kg	200	15° 15°	180°	360°	



## ■ BT7515 Double Arm Wall Mount with Tilt & Swivel

Recommended Max Screen	Max Load	Max VESA	Tilt	Swivel	QR Code
47" 120cm	25kg	200	40° 40°	180°	



## Flat Screen Wall Mounts - Medium

Model Number	Function	Recommended Screen Size	Max Load	Max VESA	Tilt	Swivel	Rotation	Distance From Wall	Lateral Shift	On Wall Levelling	System 2 Compatible
BT7532	Fixed	22" - 47"	40kg	200	N/A	N/A	N/A	15mm	<input checked="" type="checkbox"/>	N/A	N/A
BT8200	Fixed	22" - 47"	40kg	200	N/A	N/A	N/A	14mm	<input checked="" type="checkbox"/>	N/A	N/A
BTV500	Fixed	22" - 47"	40kg	200	N/A	N/A	N/A	20mm	<input checked="" type="checkbox"/>	N/A	N/A
BT7523	Tilt	22" - 47"	25kg	200	+/-15°	N/A	N/A	52mm	N/A	<input checked="" type="checkbox"/>	<input checked="" type="checkbox"/>
BTV502	Tilt & Swivel	22" - 47"	25kg	200	+/-15°	+180°	360°	95mm	N/A	N/A	N/A
BTV503	Single Arm	22" - 47"	25kg	200	+/-15°	+180°	360°	79 - 240mm	N/A	N/A	N/A
BT7514	Single Arm	22" - 47"	25kg	200	+/-40°	+180°	N/A	95 - 336mm	N/A	<input checked="" type="checkbox"/>	<input checked="" type="checkbox"/>
BTV504	Double Arm	22" - 47"	25kg	200	+/-15°	+180°	360°	79 - 385mm	N/A	N/A	N/A
BT7515	Double Arm	22" - 47"	25kg	200	+/-40°	+180°	N/A	95 - 525mm	N/A	<input checked="" type="checkbox"/>	<input checked="" type="checkbox"/>



## Simple Installation

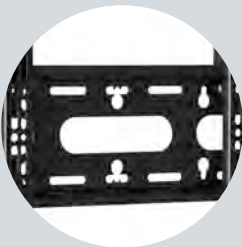

Keyhole wall fixings for easy installation\*

## Post Installation Adjustments



Interface arms feature height adjustment screws to level the screen once mounted\*

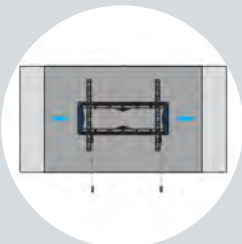

Post installation lateral adjustment for optimal screen positioning on a wall

\*Not included on Elements mounts

### ■ BTV510 Fixed Wall Mount

Recommended Max Screen	Max Load	Max VESA	QR Code
55" / 140cm	50kg	400	



### elements • fixed 400

### ■ BT5441 Fixed Wall Mount

Recommended Max Screen	Max Load	Max VESA	QR Code
65" / 165cm	50kg	400	



### ■ BT8441 Fixed Wall Mount

Recommended Max Screen	Max Load Wall	Max Load Pole	Max VESA	QR Code
65" / 165cm	80kg	50kg	400	



### elements • tilt 400

### ■ BT5431 Wall Mount with Tilt

Recommended Max Screen	Max Load	Max VESA	Tilt	QR Code
65" / 165cm	50kg	400	15°	



### ■ BT8431 Wall Mount with Tilt

Recommended Max Screen	Max Load	Max VESA	Tilt	QR Code
65" / 165cm	50kg	400	15° / 15°	



### ■ BTV513 Ultra-Slim Double Arm Wall Mount with Tilt and Swivel

Recommended Max Screen	Max Load	Max VESA	Tilt	Swivel	QR Code
55" / 140cm	35kg	400	2° / 10°	180°	



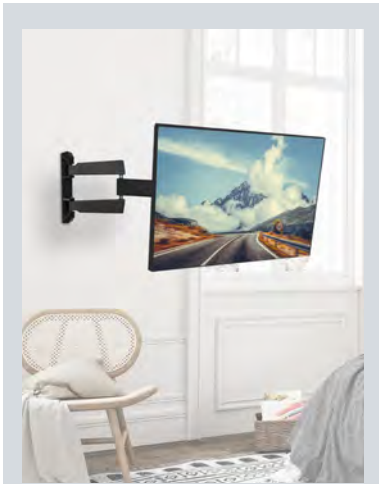

## Easy Screen Positioning



Double arm wall mounts feature 3 pivot points and tool-less tilt adjustment for optimum screen positioning

### elements • reach 35

#### BT5226 Double Arm Wall Mount with Tilt and Swivel

Recommended Max Screen	Max Load	Max VESA	Tilt	Swivel	QR Code
65" / 165cm	35kg	600 x 400	2° / 12°	180°	



### vantage • elite

#### BT8226 Double Arm Wall Mount with Tilt and Swivel

Recommended Max Screen	Max Load	Max VESA	Tilt	Swivel	QR Code
65" / 165cm	35kg	600 x 400	3° / 14°	180°	



### vantage • extra

#### BT8229 Double Arm Wall Mount with Tilt and Swivel

Suitable for mounting to 16" stud walls

Recommended Max Screen	Max Load	Max VESA	Tilt	Swivel	QR Code
65" / 165cm	35kg	600 x 400	3° / 14°	180°	



## Flat Screen Wall Mounts - Large

Model Number	Function	Recommended Screen Size	Max Load	Max VESA	Tilt	Swivel	Screen Rotation	Distance From Wall	Lateral Shift	Keyhole Fixings	System 2 Compatible
BTV510	Fixed	32" - 55"	50kg	400	N/A	N/A	N/A	20mm	<input checked="" type="checkbox"/>	N/A	N/A
BT5441	Fixed	32" - 65"	50kg	400	N/A	N/A	N/A	30mm	<input checked="" type="checkbox"/>	N/A	N/A
BT8441	Fixed	32" - 65"	80kg	400	N/A	N/A	N/A	30mm	<input checked="" type="checkbox"/>	<input checked="" type="checkbox"/>	<input checked="" type="checkbox"/>
BT5431	Tilt	32" - 65"	50kg	400	+15°	N/A	N/A	48mm	<input checked="" type="checkbox"/>	N/A	N/A
BT8431	Tilt	32" - 65"	50kg	400	+/-15°	N/A	N/A	81mm	<input checked="" type="checkbox"/>	<input checked="" type="checkbox"/>	<input checked="" type="checkbox"/>
BTV513	Double Arm	32" - 55"	35kg	400	+10°/-2°	+180°	N/A	40 - 450mm	<input checked="" type="checkbox"/>	N/A	N/A
BT5226	Double Arm	32" - 65"	35kg	600 x 400	+12°/-2°	+180°	N/A	55 - 495mm	<input checked="" type="checkbox"/>	<input checked="" type="checkbox"/>	<input checked="" type="checkbox"/>
BT8226	Double Arm	32" - 65"	35kg	600 x 400	+14°/-3°	+180°	N/A	62 - 587mm	<input checked="" type="checkbox"/>	<input checked="" type="checkbox"/>	<input checked="" type="checkbox"/>
BT8229	Double Arm	32" - 65"	35kg	600 x 400	+14°/-3°	+180°	N/A	65 - 590mm	<input checked="" type="checkbox"/>	<input checked="" type="checkbox"/>	<input checked="" type="checkbox"/>



## Safe & Secure



Locking holes on screen mounts allow the user to attach a small padlock (not supplied) for additional security\*

\*Not featured on Elements mounts

## Comprehensive Fixing Kits



All wall mounts come complete with all necessary fixings for a hassle free installation

## ALSO AVAILABLE...

### Accessory Mounting Arm



**BT7031**

Use BT7031 (page 102) to mount a shelf or video bar above or below the screen.

Compatible with: **BT8431, BT8432, BT8441, BT8442, BT9901 & BT9903** wall mounts

## BTV520 Fixed Wall Mount

Recommended Max Screen	Max Load	Max VESA	QR Code
65" / 165cm	70kg	800	



## elements • fixed 600

## BT5442 Wall Mount

Recommended Max Screen	Max Load Wall	Max VESA	Tilt	QR Code
80" / 203cm	80kg	600 x 400	15° / 15°	



## BT8442 Fixed Wall Mount

Recommended Max Screen	Max Load Wall	Max Load Pole	Max VESA	QR Code
80" / 203cm	80kg	50kg	600 x 400	



## elements • tilt 600

## BT5432 Wall Mount with Tilt

Recommended Max Screen	Max Load Wall	Max VESA	Tilt	QR Code
80" / 203cm	70kg	600 x 400	15° / 15°	



## BT8432 Wall Mount with Tilt

Recommended Max Screen	Max Load Wall	Max Load Pole	Max VESA	Tilt	QR Code
80" / 203cm	70kg	50kg	600 x 400	15° / 15°	





## Cable Management



Integrated cable management on articulating mounts

## Drilling Templates



For an easy install, heavier Vantage mounts include a drilling template

## elements • access

- **BT8443**  
Pull-Out Wall Mount with Tilt and Swivel



Recommended Max Screen	Max Load Wall	Max VESA	Tilt	Swivel	QR Code
75" / 190cm	35kg	600 x 400	2° / 10°	28°	

## elements • reach 45

- **BT5227**  
Double Arm Wall Mount with Tilt and Swivel



Recommended Max Screen	Max Load Wall	Max VESA	Tilt	Swivel	QR Code
75" / 190cm	45kg	600 x 400	2° / 12°	180°	

## vantage • plus

- **BT8227**  
Double Arm Wall Mount with Tilt and Swivel



Recommended Max Screen	Max Load Wall	Max VESA	Tilt	Swivel	QR Code
75" / 190cm	50kg	600 x 400	3° / 14°	180°	

## Flat Screen Wall Mounts - XL Large

Model Number	Function	Recommended Screen Size	Max Load	Max VESA	Tilt	Swivel	Screen Rotation	Distance From Wall	Lateral Shift	Keyhole Fixings	System 2 Compatible	Single Pole Max Load
BTV520	Fixed	42" - 65"	70kg	800 x 500	N/A	N/A	N/A	20mm	✓	N/A	N/A	N/A
BT5442	Fixed	42" - 80"	80kg	600 x 400	N/A	N/A	N/A	30mm	✓	N/A	N/A	N/A
BT8442	Fixed	42" - 80"	80kg	600 x 400	N/A	N/A	N/A	30mm	✓	✓	✓	50kg
BT5432	Tilt	42" - 80"	70kg	600 x 400	+/-15°	N/A	N/A	81mm	✓	N/A	N/A	N/A
BT8432	Tilt	42" - 80"	70kg	600 x 400	+/-15°	N/A	N/A	81mm	✓	✓	✓	50kg
BT8443	Pull-Out	42" - 75"	35kg	600 x 400	+10°/-2°	+28°	N/A	69 - 220mm	✓	N/A	N/A	N/A
BT5227	Double Arm	42" - 75"	45kg	600 x 400	+12°/-2°	+180°	N/A	62-720mm	✓	N/A	N/A	N/A
BT8227	Double Arm	42" - 75"	50kg	600 x 400	+14°/-3°	+180°	N/A	63-582mm	✓	N/A	N/A	N/A



## Pole Mounting



A large selection of pole mounting options are available using System 2 components



The recommended screen size in the table below encompasses both the minimum and maximum dimensions suitable for each mounting bracket.

### BT9901 Fixed Wall Mount for XL Screens

Recommended Max Screen	Max Load	Max VESA	QR Code
100" / 254cm	100kg	900 x 600	



### BT9903 Heavy-Duty Fixed Wall Mount for XL Screens

Recommended Max Screen	Max Load Wall	Max Load Pole	Max VESA	QR Code
120" / 305cm	200kg	130kg	1000 x 600	

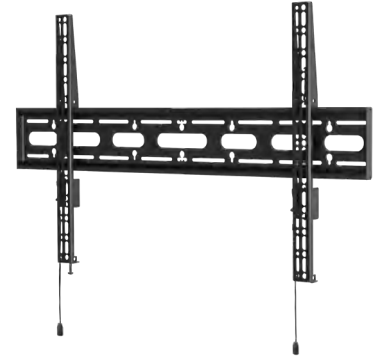

### BT9910 Wall Mount with Tilt

Recommended Max Screen	Max Load Wall	Max Load Pole	Max VESA	Tilt	QR Code
100" / 254cm	130kg	80kg	1000 x 600	15°	

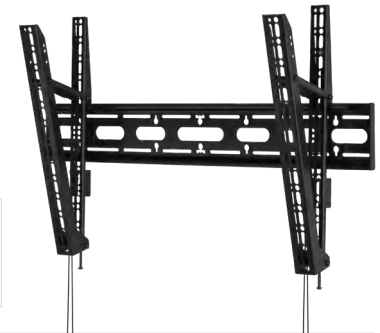

## vantage • max

### BT8228 Twin Cantilever Arm Wall Mount with Tilt & Swivel

Recommended Max Screen	Max Load	Max VESA	Tilt	Swivel	QR Code
120" / 305cm	125kg	800 x 600	3° / 15°	130°	



## Flat Screen Wall Mounts - XXL

Model Number	Function	Recommended Screen Size	Max Load	Max VESA	Tilt	Swivel	Screen Rotation	Distance From Wall	Lateral Shift	Keyhole Fixings	System 2 Compatible	Twin Pole Mounted Max Load
BT9901	Fixed	55"-100"	100kg	900 x 600	N/A	N/A	N/A	30mm	✓	✓	✓	N/A
BT9903	Fixed	65"-120"	200kg	1000 x 600	N/A	N/A	N/A	35mm	✓	✓	✓	130kg
BT9910	Tilt	65"-100"	130kg	1000 x 600	+15°	N/A	N/A	82mm	✓	✓	✓	80kg
BT8228	Double Arm	65"-120"	125kg	800 x 600	+15°/-3°	130°	N/A	90mm - 628mm	✓	✓	✓	N/A



Use adaptors to increase the VESA fixings on existing screen mounts

VESA adaptors can be added to a range of interfaces to increase their horizontal or vertical mounting patterns

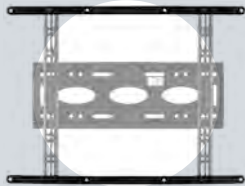
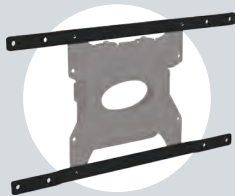

**BT7542**  
Interface Adaptor Arms  
for VESA200 x 100 & 200 x 200



**BT7502**  
Interface Adaptor Plate  
for VESA 200 x 100 & 200 x 200



**BT7540**  
Interface Adaptor Arms  
for VESA 300 x 200 & 400 x 200



**BT7564**  
Interface Adaptor Arms  
for VESA 600 x 400



**BT7565**  
Interface Adaptor Arms  
for VESA 800 x 400 & 900 x 400



**VESA Adaptor Arms**

Model Number	Recommended Screen Size	Max Load*	VESA Mounting	VESA Attachment	VESA X2 Adaptors	Steel Thickness	Overall Depth	System 2 Compatible
BT7542	N/A	N/A	200 x 100 / 200 x 200	100 / 200 x 100	N/A	4mm	7mm	N/A
BT7502	N/A	N/A	200 x 100 / 200 x 200	75 / 100	200 x 200	4mm	8mm	N/A
BT7540	N/A	N/A	300 x 200 / 400 x 200	100 / 200	400 x 400	4mm	7mm	N/A
BT7564	N/A	N/A	600	200 / 400	N/A	6mm	6mm	N/A
BT7565	N/A	N/A	500 / 600 / 700 / 800 / 900	200 / 400	N/A	6mm	6mm	N/A

\*Max load and screen size dependent on the mount the adaptor is attached to

# Flat Screen Ceiling Mounts



## B-Tech has a wide range of screen ceiling mounting kits available for small to XXL screens.

With options for fixed or tool-less adjustable drops, installations onto flat or angled ceilings, and landscape and portrait mounting, B-Tech offer a vast array of ceiling mounting solutions; additional options are also available by using System 2 parts to create custom solutions. These include joiners to extend pole lengths and specialist mounts for fixing joists, purlins, I-beams, etc.

See [page 132](#) for information about creating custom mounting solutions. For full specifications, scan the QR code to visit the online product page.

## Key Features

- Mounts are available with either a fixed drop or with a tool-less adjustment of the ceiling drop
- Unique 'Torsion-tilt' mechanism for tilt adjustment on a selection of mounts
- Suitable for landscape or portrait mounting
- Lateral adjustment of the screen once mounted
- Arms feature adjustment screws to help level the screen height
- Security screws help prevent unauthorised removal of screens
- Integrated cable management
- Cover plate included for a smart installation
- Simple 'hook-on' installation with all mounting hardware included
- For more custom installations, see our System 2 range of components



## Adjustable Drop



Tool-Less height adjustment in 25mm increments

## Fixed Drop



Fixed drop ceiling mounts mounting kits available with options for different poles lengths

### BT7553 Ceiling Mount with Tilt & Swivel

Available in 4 pole lengths

BT7553-050	0.5m Pole
BT7553-100	1m Pole
BT7553-150	1.5m Pole
BT7553-200	2m Pole

Recommended Max Screen	Max Load	Max VESA	Tilt	Swivel	Rotation	QR Code
28" / 71cm	23kg	100	15° / 90°	360°	360°	



### BT8420 Adjustable Drop Ceiling Mount with Tilt

Recommended Max Screen	Max Load	Max VESA	Tilt	QR Code
47" / 120cm	25kg	200	40° / 40°	



### BT8424 Ceiling Mount with Tilt

Available in 4 pole lengths

BT8424-100	1m Pole
BT8424-150	1.5m Pole
BT8424-200	2m Pole
BT8424-300	3m Pole

Recommended Max Screen	Max Load	Max VESA	Tilt	QR Code
65" / 165cm	50kg	600 x 400	15° / 15°	





## Ceiling Mount Colour Options



Fixed drop mounts available with a choice of black, white or chrome poles

## Landscape & Portrait Mounting Options



Supplied 600mm VESA adaptors can mount screens in either landscape or portrait orientation

## Cable Management



Screen cables can pass through the pole and exit via the top or side of the ceiling mount

### ■ BT8426 Adjustable Drop Ceiling Mount with Tilt

Recommended Max Screen	Max Load	Max VESA	Tilt	QR Code
65" / 165cm	50kg	600 x 400	15° / 15°	



### ■ BT8428 Back-To-Back Ceiling Mount with Tilt

Available in 4 pole lengths

BT8428-100	1m Pole
BT8428-150	1.5m Pole
BT8428-200	2m Pole
BT8428-300	3m Pole

Recommended Max Screen	Max Load	Max VESA	Tilt	QR Code
65" / 165cm	50kg per screen	600 x 400	15° / 15°	



### ■ BT8427 Adjustable Drop Ceiling Mount with Tilt

Recommended Max Screen	Max Load	Max VESA	Tilt	QR Code
75" / 190cm	70kg	600 x 400	20°	





## Fixed Ceiling Drop Options



Available with a choice of 4 ceiling drops: 1m, 1.5m, 2m and 3m

## BT8448 XL Display Ceiling Mount

Available in 4 pole lengths

BT8448-100	1m Pole
BT8448-150	1.5m Pole
BT8448-200	2m Pole
BT8448-300	3m Pole

Recommended Max Screen	Max Load	Max VESA	QR Code
120" 254cm	130kg	1000 x 600	



## BT8449 XL Display Ceiling Mount with Tilt

Available in 4 pole lengths

BT8449-100	1m Pole
BT8449-150	1.5m Pole
BT8449-200	2m Pole
BT8449-300	3m Pole

Recommended Max Screen	Max Load	Max VESA	Tilt	QR Code
100" 254cm	80kg	1000 x 600	15°	



## Flat Screen Ceiling Mounts

Model Number	Recommended Screen Size	Max Load	Max VESA	Tilt	Swivel	Screen Rotation	Lateral Shift	Adjustable Height	Ceiling Drop to centre of screen	Colour Options
BT7553	10" - 32"	23kg	100	+90° / -15°	360°	360°	N/A	N/A	732mm / 1232mm / 1732mm / 2232mm	<input checked="" type="checkbox"/>
BT8420	22" - 47"	25kg	200	+/-40°	N/A	N/A	N/A	<input checked="" type="checkbox"/>	600mm - 1000mm	N/A
BT8424	32" - 65"	50kg	600 x 400	+/-15°	N/A	N/A	<input checked="" type="checkbox"/>	N/A	1003mm / 1503mm / 2003mm / 3003mm	N/A
BT8426	32" - 65"	50kg	600 x 400	+/-15°	N/A	N/A	<input checked="" type="checkbox"/>	<input checked="" type="checkbox"/>	625mm - 950mm	N/A
BT8428	32" - 65"	50kg Per Screen	600 x 400	+/-15°	N/A	N/A	<input checked="" type="checkbox"/>	N/A	960mm / 1460mm / 1960mm / 2960mm	N/A
BT8427	32" - 75"	70kg	600 x 400	+20°	N/A	N/A	<input checked="" type="checkbox"/>	<input checked="" type="checkbox"/>	572mm - 972mm	<input checked="" type="checkbox"/>
BT8448	65" - 120"	130kg	1000 x 600	N/A	N/A	N/A	<input checked="" type="checkbox"/>	N/A	980mm / 1480mm / 1980mm / 2980mm	<input checked="" type="checkbox"/>
BT8449	65" - 100"	80kg	1000 x 600	+15°	N/A	N/A	<input checked="" type="checkbox"/>	N/A	980mm / 1480mm / 1980mm / 2980mm	<input checked="" type="checkbox"/>

■ Small 
 ■ Medium 
 ■ Large 
 ■ Extra Large

# Flat Screen Desk Mounts



## Effortless Installation, Seamless Adjustment, and Exceptional User Experience!

A wide selection of desk mounts for monitors are available from B-Tech, including the Flex range of full motion mounts suitable for single, double or triple screen displays. All desk mounts are supplied with both a desk clamp and a grommet plate for versatile mounting options. Bolt down and wall mounted options are also available. All mounts feature designs with simple adjustments of height, swivel, tilt and screen rotation for easy positioning of the display.

**Scan the QR codes to visit the online product page for full specifications.**

## Key Features

- High-end aesthetic quality with a durable powder-coated finish
- Swivel points at the pole and interface
- Easy height adjustment
- Premium and full motion desk mounts supplied with a desk clamp and grommet
- Simple 'hook-on' installation with all mounting hardware included
- Options for single, twin or triple-screen installations
- Integrated cable management systems

**BTech**<sup>®</sup> | flex  
AV Mounts

The **Flex range** is the latest desktop mounting solutions from B-Tech, available as single, twin or triple screen desk mounts



**Full Motion Desktop Mounts**, provide seamless height adjustment and ensure optimal screen positioning for an enhanced viewing experience.

## ■ BT7553 Bolt-Down Desk Mount



Available in 4 pole lengths

BT7553-050	0.5m Pole
BT7553-100	1m Pole
BT7553-150	1.5m Pole
BT7553-200	2m Pole

Recommended Max Screen	Max Load	Max VESA	Tilt	Swivel	Rotation	QR Code
32" / 81cm	23kg	100	90° / 15°	360°	360°	

BT7553 can also be ceiling mounted



## Full Motion Desk Mounts

flex • solo



## ■ BT7351 Desk Mount with Tilt & Swivel

Recommended Max Screen	Max Load	Max VESA	Tilt	Swivel	Rotation	QR Code
32" / 81cm	9kg	100	60° / 60°	360°	360°	



flex • duo



## ■ BT7352 Twin Screen Desk Mount with Tilt & Swivel

Recommended Max Screen	Max Load	Max VESA	Tilt	Swivel	Rotation	QR Code
32" / 81cm	9kg per screen	100	60° / 60°	360°	360°	



flex • trio



## ■ BT7353 Triple Screen Desk Mount with Tilt & Swivel

Recommended Max Screen	Max Load	Max VESA	Tilt	Swivel	Rotation	QR Code
32" / 81cm	9kg per screen	100	60° / 60°	360°	360°	





## Desk Clamp & Grommet Mounting



Desktop mounts supplied with desk clamps and grommet mounting options

**ALSO AVAILABLE...**

### BT7399 Wall Mount Accessory



Designed to attach any B-Tech premium desk mount or premium full motion desk mount to the wall

### BT7371 Premium Desk Mount with Swivel

Recommended Max Screen	Max Load	Max VESA	Tilt	Swivel	Rotation	QR Code
32" / 81cm	9kg	100	90° / 65°	360°	360°	



### BT7372 Premium Single Arm Desk Mount with Tilt and Swivel

Recommended Max Screen	Max Load	Max VESA	Tilt	Swivel	Rotation	QR Code
32" / 81cm	9kg	100	90° / 65°	360°	360°	



### BT7373 Premium Double Arm Desk Mount with Tilt and Swivel

Recommended Max Screen	Max Load	Max VESA	Tilt	Swivel	Rotation	QR Code
32" / 81cm	9kg	100	90° / 65°	360°	360°	



### BT7374 Premium Twin Screen Desk Mount with Tilt and Swivel

Recommended Max Screen	Max Load	Max VESA	Tilt	Swivel	Rotation	QR Code
32" / 81cm	9kg per screen	100	90° / 65°	360°	360°	



### BT7383 Premium Full Motion Double Arm Desk Mount

Recommended Max Screen	Max Load	Max VESA	Tilt	Swivel	Rotation	QR Code
32" / 81cm	9kg	100	90° / 65°	360°	360°	







## Full Motion Arm Movement



Full motion, height, swivel and tilt adjustments

### ■ BT7355 Heavy Duty Full Motion Desk Mount



Recommended Max Screen	Max Load	Max VESA	Tilt	Swivel	Rotation	QR Code
49" 125cm	20kg	100	55° 5°	360°	360°	

### ■ BT7356 Heavy Duty Full Motion Wall Mount



Recommended Max Screen	Max Load	Max VESA	Tilt	Swivel	Rotation	QR Code
55" 140cm	20kg	400	55° 5°	180°	360°	

## Flat Screen Desk Mounts

Model Number	Mount Option	Recommended Screen Size	Max Load	Max VESA	Tilt	Swivel	Screen Rotation	Screens Mounted	Arm Extension
BT7553	Bolt-Down	10" - 32"	23kg	100	+15°/-90°	360°	360°	1	N/A
BT7351	Grommet / Desk Clamp	10" - 32"	9kg	100	+60°/-60°	360°	360°	1	538mm
BT7352	Grommet / Desk Clamp	10" - 32"	9kg Per Screen	100	+60°/-60°	360°	360°	2	538mm
BT7353	Grommet / Desk Clamp	10" - 32"	9kg Per Screen	100	+60°/-60°	360°	360°	3	705mm
BT7371	Grommet / Desk Clamp	10" - 32"	9kg	100	+65°/-90°	360°	360°	1	N/A
BT7372	Grommet / Desk Clamp	10" - 32"	9kg	100	+65°/-90°	360°	360°	1	255mm
BT7373	Grommet / Desk Clamp	10" - 32"	9kg	100	+65°/-90°	360°	360°	1	455mm
BT7374	Grommet / Desk Clamp	10" - 32"	9kg Per Screen	100	+65°/-90°	360°	360°	2	455mm
BT7383	Grommet / Desk Clamp	10" - 32"	9kg	100	+65°/-90°	360°	360°	1	586mm
BT7355	Grommet / Desk Clamp	10" - 49"	2-20kg	100	+5°/-55°	360°	360°	1	472mm
BT7356	Wall Mount	10" - 55"	2-20kg	400	+5°/-55°	180°	360°	1	582mm

# Floor Stands & Mobile Solutions



**Durable and stylish Trolleys and Floor Stands blend lasting build quality with striking aesthetics, ideal for versatile display positioning in corporate, education, government, and hospitality markets.**

B-Tech offer screen solutions for a huge variety of screen sizes, including robust interactive touchscreens. These solutions cater to both landscape and portrait orientations. Accompanying shelving solutions from our AV accessory collection complement this range perfectly with other accessories and media storage devices that can be fitted to most options.

In addition to mobile solutions, our selection includes freestanding floor stands. These stands feature low-profile bases with Ø50mm poles or aluminium columns for an alternative aesthetic; our mounting kits can also be purchased as separate components (*see page 146*), allowing for precise customisation based on your installation needs. For more robust requirements, explore our heavy-duty floor stands utilising the System X range of components (*see page 116*), ideal for multi-screen displays.

Access complete product specifications, technical drawings, and colour options by scanning the QR code for each product to access the online page.

## Key Features

- Universal designs suitable for displaying screens in a landscape or portrait orientation
- Non-marking locking / braked castors included with mobile displays trolleys
- Collar compatible accessories such as shelves and video bar adaptors (*available separately*) can be fitted to the column or pole
- Integrated cable management for a smart installation
- Simple 'hook-on' screen installation with all mounting hardware included



**The Momentum range** is a collection of the latest mobile mounting solutions available from B-Tech



### Mobile Displays



### Freestanding Displays



### Twin Screen VC Displays

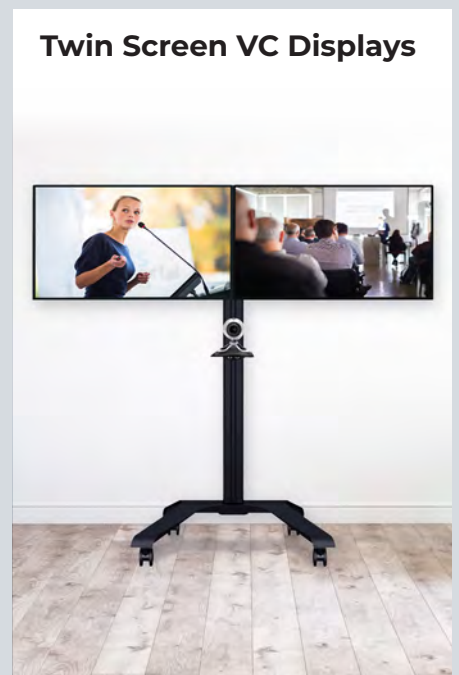



**Designer Trolley**  
Colour Options



**ALSO AVAILABLE...**

**BT7550-SF2**  
Samsung Flip 2 & Flip Pro Adaptor



Use with **BT8566 / BT7550** for Samsung WMR / WMB flip displays

**ALSO AVAILABLE...**

**BT856-FEET**  
Adjustable Levelling Feet



**BT856-FEET** are available in packs of 4 and allow the **Designer Trolleys** to be fitted with adjustable levelling feet for a freestanding installation

**BT8562**  
Designer Flat Screen Trolley



Recommended Max Screen	Max Load	Max VESA	QR Code
75" / 190cm	70kg	600 x 400	

**BT8566**  
Designer Flat Screen Trolley with Flip Rotation  
Ideal for use with **SAMSUNG FLIP**



Recommended Max Screen	Max Load	Max VESA	Tilt	Rotation	QR Code
75" / 190cm	70kg	600 x 400	4.5°	90°	

**BT8564**  
Designer Flat Screen Trolley for XL Screens



Recommended Max Screen	Max Load	Max VESA	QR Code
120" / 305cm	130kg	1000 x 600	

## momentum • one

### ■ BT7504 Flat Screen Trolley

Recommended Max Screen	Max Load	Max VESA	QR Code
55" 140cm	25kg	400	



Suitable for landscape and portrait mounting. Accessorise trolleys with AV shelves



Use **BT7841 Accessory Collars** (not included) To retro-fit shelves onto existing installations



Non-marking **Braked Castors** included with all trolleys



Adjustable levelling feet included with standard trolleys **BT8503, BT8504, BT8506 & BT8540**

### ■ BT8503 Flat Screen Trolley / Stand

Also suitable for portrait displays up to VESA 800x400

Recommended Max Screen	Max Load	Max VESA	QR Code
60" 152cm	50kg	800 x 600	

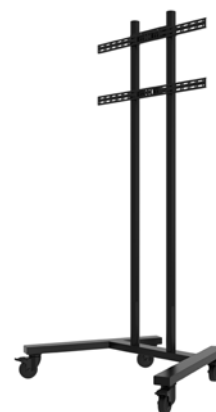

## momentum • two

### ■ BT8504 Flat Screen Trolley / Stand

Recommended Max Screen	Max Load	Max VESA	QR Code
75" 190cm	70kg	600 x 400	



## momentum • grand

### ■ BT8506 Flat Screen Trolley / Stand for XL Screens

Recommended Max Screen	Max Load	Max VESA	QR Code
120" 305cm	130kg	1000 x 600	





## momentum • edge

■ **BT8545**  
Flat Screen Trolley  
for XL Screens



Ideal for mounting  
XL interactive and  
touchscreen displays



Simple screen installation with  
manually adjustable height  
positions for an optimal display

Recommended Max Screen	Max Load	Max VESA	QR Code
86" 218cm	100kg	800 x 600	

## momentum • edge XL

■ **BT8546**  
Flat Screen Trolley  
for XL Screens



Ideal for mounting  
XXL interactive and  
touchscreen displays



BT8545

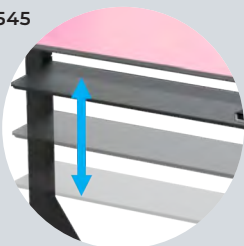

BT8546



Includes AV shelf  
with multiple  
mounting options

Recommended Max Screen	Max Load	Max VESA	QR Code
110" 279cm	125kg	1000 x 800	



Suitable for extra large displays. Such as LG'S 110UM5J, large touchscreens and interactive displays

**BT8590**  
Flat Screen Trolley  
for XL Screens



Recommended Max Screen	Max Load	Max VESA	
120" 305cm	130kg	1600 x 800	



**BT8540**  
Low Level  
Flat Screen Trolley



Recommended Max Screen	Max Load	Max VESA	Tilt	
65" 165cm	70kg	600 x 400	90°	



Low level stands feature 5 fixed upward tilt positions: 0°, 22.5°, 45°, 67.5° and 90° for an optimal display

**BT8541**  
Low Level  
Flat Screen Stand



Recommended Max Screen	Max Load	Max VESA	Tilt	
65" 165cm	70kg	600 x 400	90°	



BT8568 & BT8569 supplied with optional aesthetic blanking panel



Motorised height adjustment with built in safety features such as automatic stop when resistance is felt



AV shelves can be fitted to rear of the BT8568 trolley



BT8558 / BT8559 supplied with media storage cradle

## momentum • e-lift

### ■ BT8558 Motorised Height Adjustable Flat Screen Trolley



Recommended Max Screen	Max Load	Max VESA	CE	UK CA	QR Code
100" / 254cm	100kg	900 x 600	CE	UK CA	QR Code

### ■ BT8568 Motorised Height Adjustable Flat Screen Trolley



Recommended Max Screen	Max Load	Max VESA	CE	UK CA	QR Code
86" / 218cm	100kg	1000 x 600	CE	UK CA	QR Code

## momentum • elevate

### ■ BT8559 Motorised Height Adjustable Flat Screen Stand

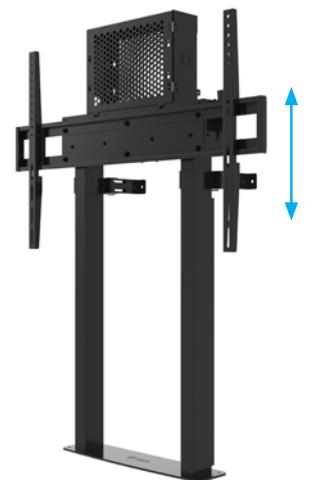

Recommended Max Screen	Max Load	Max VESA	CE	UK CA	QR Code
100" / 254cm	100kg	900 x 600	CE	UK CA	QR Code



## BT8569 Motorised Height Adjustable Floor-To-Wall Flat Screen Stand

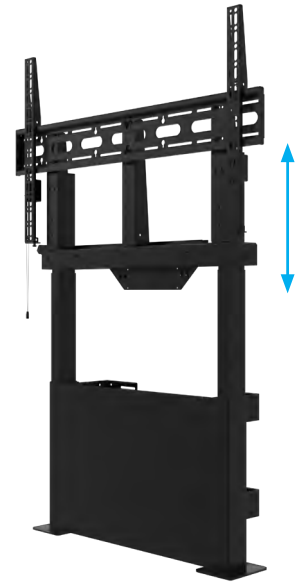

Motorised height adjustment displays supplied with a wired control panel

Recommended Max Screen 86" 218cm	Max Load 100kg	Max VESA 1000 x 600	CE	UK CA	
--	-------------------	------------------------------	----	----------	--

## Single Screen Mobile Stands

Model Number	Function	Recommended Screen Size	Max Load	Max VESA	Tilt	Lateral Shift	Levelling Feet	Dimensions	Colour Options
BT8562	Mobile	32" - 75"	70kg	600x400	N/A	<input checked="" type="checkbox"/>	BT856-FEET*	H.1858 W.1029mm D.767mm	<input checked="" type="checkbox"/>
BT8566	Mobile	32" - 75"	70kg	600x400	-4.5°	<input checked="" type="checkbox"/>	BT856-FEET*	H.1932 W.1075mm D.863mm	<input checked="" type="checkbox"/>
BT8564	Mobile	65" - 120"	130kg	1000x600	N/A	<input checked="" type="checkbox"/>	BT856-FEET*	H.1905mm W.1241mm D.767mm	<input checked="" type="checkbox"/>
BT7504	Mobile	22" - 55"	25kg	400x400	N/A	N/A	N/A	H.1210mm W.759mm D.455mm	N/A
BT8503	Mobile	39" - 65"	50kg	800x600	N/A	<input checked="" type="checkbox"/>	<input checked="" type="checkbox"/>	H.1940mm W.1120mm D.782mm	N/A
BT8504	Mobile	32" - 75"	70kg	600x400	N/A	<input checked="" type="checkbox"/>	<input checked="" type="checkbox"/>	H.1854mm W.1098mm D.740mm	N/A
BT8506	Mobile	65" - 120"	130kg	1100x700	N/A	<input checked="" type="checkbox"/>	<input checked="" type="checkbox"/>	H.1649mm W.1660mm D.810mm	N/A
BT8545	Mobile	55" - 86"	100kg	800x600	N/A	<input checked="" type="checkbox"/>	N/A	H.1722 W.1050mm D.882mm	N/A
BT8546	Mobile	65" - 110"	125kg	1000x800	N/A	<input checked="" type="checkbox"/>	N/A	H.1778 W.1245mm D.772mm	N/A
BT8590	Mobile	72" - 120"	130kg	1600x800	N/A	<input checked="" type="checkbox"/>	BT856-FEET*	H.1905mm W.1755mm D.767mm	<input checked="" type="checkbox"/>
BT8540	Mobile	39" - 65"	70kg	600x400	-90°	<input checked="" type="checkbox"/>	<input checked="" type="checkbox"/>	H.920mm W.1096mm D.738mm	N/A
BT8541	Freestanding	39" - 65"	70kg	600x400	-90°	<input checked="" type="checkbox"/>	N/A	H.839mm W.800mm D.600mm	N/A
BT8558	Mobile	55" - 100"	100kg	900x600	N/A	<input checked="" type="checkbox"/>	N/A	H.1106 - 1751mm W.1086mm D.833mm	N/A
BT8568	Mobile	55" - 86"	100kg	1000x600	N/A	<input checked="" type="checkbox"/>	<input checked="" type="checkbox"/>	H.1360-2010mm W.1255mm D.740mm	N/A
BT8559	Floor-To-Wall	55" - 100"	100kg	900x600	N/A	<input checked="" type="checkbox"/>	N/A	H.1310 - 1960mm W.1000mm D.202 - 252mm	N/A
BT8569	Floor-To-Wall	55" - 86"	100kg	1000x600	N/A	<input checked="" type="checkbox"/>	N/A	H.1220 - 1870mm W.1070mm D.256 - 272mm	N/A

\*Available Separately



■ **BT8570**  
Small  
Flat Screen  
Single Pole  
Floor Stand



Recommended Max Screen	Max Load
28" / 71cm	8kg
Max VESA	
100	

■ **BT8571**  
Medium  
Flat Screen  
Single Pole  
Floor Stand



Recommended Max Screen	Max Load
47" / 120cm	25kg
Max VESA	
200	

■ **BT8572**  
Large  
Flat Screen  
Single Pole  
Floor Stand



Recommended Max Screen	Max Load
55" / 140cm	40kg
Max VESA	
600 x 400	

■ **BT8573**  
Large  
Flat Screen  
Twin Pole  
Floor Stand

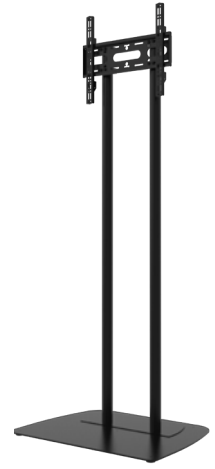

Recommended Max Screen	Max Load
75" / 190cm	70kg
Max VESA	
600 x 400	

## Flat Screen Floor Stands | Columns



■ **BT8581**  
Medium  
Flat Screen  
Single Column  
Floor Stand



Recommended Max Screen	Max Load
47" / 119cm	35kg
Max VESA	
200	

■ **BT8582**  
Large  
Flat Screen  
Single Column  
Floor Stand



Recommended Max Screen	Max Load
55" / 140cm	40kg
Max VESA	
600 x 400	

■ **BT8583**  
Large  
Flat Screen  
Twin Column  
Floor Stand

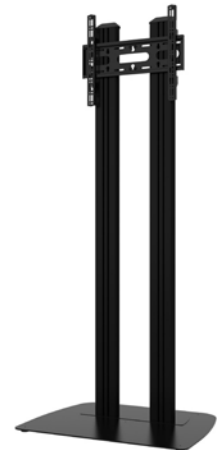

Recommended Max Screen	Max Load
75" / 190cm	70kg
Max VESA	
600 x 400	



**BTF840**  
Flat Screen  
Floor Stand



Recommended Max Screen	Max Load	Max VESA	QR Code
75" / 190cm	70kg	600 x 400	

**BTF843**  
Flat Screen  
Portrait Floor Stand



Recommended Max Screen	Max Load	Max VESA	QR Code
85" / 216cm	70kg	800 x 600	

### Single Screen Floor Stands

Model Number	Screen Size	Max Load	Max VESA	Lateral Shift	Landscape	Portrait	Pole Diameter	Pole / Column	Dimensions	Colour Options
BT8570	10" - 28"	8kg	100x100	N/A	<input checked="" type="checkbox"/>	<input checked="" type="checkbox"/>	Ø50mm	BT4116	H.1626mm W.580mm D.400mm	N/A
BT8571	22" - 47"	25kg	200x200	N/A	<input checked="" type="checkbox"/>	<input checked="" type="checkbox"/>	Ø50mm	BT4118	H.1867mm W.700mm D.515mm	N/A
BT8572	32" - 55"	40kg	600x400	<input checked="" type="checkbox"/>	<input checked="" type="checkbox"/>	<input checked="" type="checkbox"/>	Ø50mm	BT4118	H.1826mm W.800mm D.600mm	N/A
BT8573	32" - 75"	70kg	600x400	<input checked="" type="checkbox"/>	<input checked="" type="checkbox"/>	<input checked="" type="checkbox"/>	Ø50mm	BT4118	H.1826mm W.800mm D.600mm	N/A
BT8581	22" - 47"	25kg	200x200	N/A	<input checked="" type="checkbox"/>	<input checked="" type="checkbox"/>	N/A	BT8381	H.1844mm W.700mm D.515mm	<input checked="" type="checkbox"/>
BT8582	32" - 55"	40kg	600x400	<input checked="" type="checkbox"/>	<input checked="" type="checkbox"/>	<input checked="" type="checkbox"/>	N/A	BT8381	H.1844mm W.800mm D.600mm	<input checked="" type="checkbox"/>
BT8583	32" - 75"	70kg	600x400	<input checked="" type="checkbox"/>	<input checked="" type="checkbox"/>	<input checked="" type="checkbox"/>	N/A	BT8381	H.1844mm W.800mm D.600mm	<input checked="" type="checkbox"/>
BTF840	32" - 75"	70kg	600x400	<input checked="" type="checkbox"/>	<input checked="" type="checkbox"/>	<input checked="" type="checkbox"/>	N/A	BT8380-180	H.1841mm W.890mm D.604mm	<input checked="" type="checkbox"/>
BTF843	60" - 85"	70kg	600x800	<input checked="" type="checkbox"/>	N/A	<input checked="" type="checkbox"/>	N/A	BT8380-180	H.1841mm W.890mm D.604mm	<input checked="" type="checkbox"/>
BTF841	32" - 65"	35kg Per Screen	600x400	<input checked="" type="checkbox"/>	<input checked="" type="checkbox"/>	N/A	N/A	BT8380-180	H.1841mm W.890mm D.604mm	<input checked="" type="checkbox"/>
BTF842	47" - 65"	35kg Per Screen	600x400	<input checked="" type="checkbox"/>	N/A	<input checked="" type="checkbox"/>	N/A	BT8380-240	H.2441mm W.890mm D.604mm	<input checked="" type="checkbox"/>



■ **BTF841**  
Flat Screen  
Dual Stack Floor Stand 1.8m

Ideal for landscape mounting two screens, one above the other.

Recommended Max Screen	Max Load	Max VESA	QR Code
65" / 165cm	35kg per screen	600 x 400	



■ **BTF842**  
Flat Screen  
Dual Stack Floor Stand 2.4m

Ideal for portrait mounting two screens, one above the other.

Recommended Max Screen	Max Load	Max VESA	QR Code
65" / 165cm	35kg per screen	600 x 400	



## Twin Screen VC Floor Stands



■ **BT8521**  
Twin Screen VC Stand  
for screens up to 46"

Recommended Max Screen	Max Load	Max VESA	QR Code
46" / 116cm	20kg per screen	400	

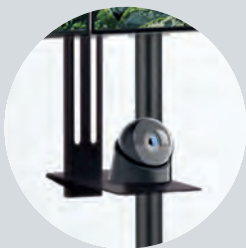

All twin screen mounts include a VC shelf and adjustable mounting arm which can mount a camera above or below the screens

■ **BTF845**  
Twin Screen VC Stand  
for screens up to 55"

Recommended Max Screen	Max Load	Max VESA	QR Code
55" / 140cm	25kg per screen	600 x 400	





**ALSO AVAILABLE...**



Accessory mounts for video bars, soundbars and VC cameras available  
See page 106



Accessory mounts for video bars, soundbars and VC cameras also available

**BT8511**  
Twin Screen VC Trolley  
for screens up to 46"

Recommended Max Screen	Max Load	Max VESA	QR Code
46" 116cm	20kg per screen	400	



**BT8514**  
Twin Screen VC Trolley  
for screens up to 46"

Recommended Max Screen	Max Load	Max VESA	QR Code
46" 116cm	40kg per screen	400	



**BT8516**  
Twin Screen VC Trolley  
for screens up to 65"

Recommended Max Screen	Max Load	Max VESA	QR Code
65" 165cm	25kg per screen	600 x 400	





Integrated cable management on all stands for a tidy install

Twin screen stands  
Options for:  
**Freestanding, Mobile** or  
a **Fixed** base installation



Adjustable levelling suitable for uneven floors



Non-marking Braked Castors included with all trolleys

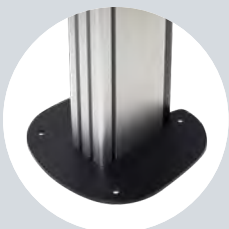

Bolt-down base with small footprint

## ■ BT8527 Twin Screen VC Stand for screens up to 75"

Recommended Max Screen	Max Load	Max VESA	QR Code
75" 190cm	100kg per screen	600 x 800	



## ■ BT8517 Twin Screen VC Trolley for screens up to 75"

Recommended Max Screen	Max Load	Max VESA	QR Code
75" 190cm	100kg per screen	600 x 800	



## ■ BT8537 Twin Screen VC Bolt-Down Stand for screens up to 75"

Recommended Max Screen	Max Load	Max VESA	QR Code
75" 190cm	100kg per screen	600 x 800	



## ■ BT8528 Twin Screen VC Stand for screens up to 86"

Recommended Max Screen	Max Load	Max VESA	QR Code
86" 220cm	100kg per screen	1000 x 800	



## ■ BT8518 Twin Screen VC Trolley for screens up to 86"

Recommended Max Screen	Max Load	Max VESA	QR Code
86" 220cm	100kg per screen	1000 x 800	



## ■ BT8538 Twin Screen VC Bolt-Down Stand for screens up to 86"

Recommended Max Screen	Max Load	Max VESA	QR Code
86" 220cm	100kg per screen	1000 x 800	





Mount accessory shelf / VC camera above or below the screens



## ■ BT8415 Twin Screen VC Wall Mount for screens up to 46"



Recommended Max Screen	Max Load	Max VESA	QR Code
46" 116cm	70kg per screen	400	

## ■ BT8416 Twin Screen VC Wall Mount for screens up to 65"



Recommended Max Screen	Max Load	Max VESA	QR Code
65" 165cm	70kg per screen	600 x 400	

## Twin Screen VC Mounts

Model Number	Function	Screen Size	Max screen Weight (Per Screen)	Max VESA	Lateral Shift	Includes VC shelf	Number of poles / columns	Dimensions	Colour Options
BT8521	Freestanding	39" - 46"	20kg	400 x 400	<input checked="" type="checkbox"/>	<input checked="" type="checkbox"/>	2	W.1505mm H.1625mm D.600mm	N/A
BT8511	Mobile	39" - 46"	20kg	400 x 400	<input checked="" type="checkbox"/>	<input checked="" type="checkbox"/>	2	W.1504mm H.1854mm D.740mm	N/A
BT8514	Mobile	39" - 46"	40kg	400 x 400	<input checked="" type="checkbox"/>	<input checked="" type="checkbox"/>	1	W.1504mm H.1905mm D.863mm	<input checked="" type="checkbox"/>
BT8415	Wall	39" - 46"	70kg	400 x 400	<input checked="" type="checkbox"/>	<input checked="" type="checkbox"/>	N/A	W.1504mm x D.290mm	N/A
BTF845	Freestanding	46" - 55"	25kg	600 x 400	<input checked="" type="checkbox"/>	<input checked="" type="checkbox"/>	1	W.1754mm H.1841mm D.604mm	<input checked="" type="checkbox"/>
BT8516	Mobile	46" - 65"	25kg	600 x 400	<input checked="" type="checkbox"/>	<input checked="" type="checkbox"/>	2	W.2004mm H.1905mm D.991mm	<input checked="" type="checkbox"/>
BT8416	Wall	46" - 65"	70kg	600 x 400	<input checked="" type="checkbox"/>	<input checked="" type="checkbox"/>	N/A	W.2004mm x D.290mm	N/A
BT8527	Freestanding	65" - 75"	100kg	600 x 800	<input checked="" type="checkbox"/>	<input checked="" type="checkbox"/>	2	W.2450mm H.2126mm D.950mm	<input checked="" type="checkbox"/>
BT8517	Mobile	65" - 75"	100kg	600 x 800	<input checked="" type="checkbox"/>	<input checked="" type="checkbox"/>	2	W.2450mm H.2220mm D.950mm	<input checked="" type="checkbox"/>
BT8537	Bolt-Down	65" - 75"	100kg	600 x 800	<input checked="" type="checkbox"/>	<input checked="" type="checkbox"/>	2	W.2450mm H.1808mm D.950mm	<input checked="" type="checkbox"/>
BT8528	Freestanding	75" - 86"	100kg	1000 x 800	<input checked="" type="checkbox"/>	<input checked="" type="checkbox"/>	2	W.3000mm H.2526mm D.950mm	<input checked="" type="checkbox"/>
BT8518	Mobile	75" - 86"	100kg	1000 x 800	<input checked="" type="checkbox"/>	<input checked="" type="checkbox"/>	2	W.3000mm H.2620mm D.950mm	<input checked="" type="checkbox"/>
BT8538	Bolt-Down	75" - 86"	100kg	1000 x 800	<input checked="" type="checkbox"/>	<input checked="" type="checkbox"/>	2	W.3000mm H.2408mm D.240mm	<input checked="" type="checkbox"/>

# Premium UC / VC Display Stands



**Mode-AL Display Engineering is a range of premium mounting solutions featuring the recognised and highly regarded Mode-AL aluminium profile.**

Mode-AL display stands are designed for Unified Communication and Video Conferencing applications in high-end corporate, government and broadcast markets. These stands cater to various mounting needs, including freestanding, bolt-down, floor-to-wall, and floor-to-ceiling options

All Mode-AL solutions can be enhanced with various VC and media mounting devices and components, which can be ordered individually to suit your installation requirements.

*Refer to the Mode-AL mounting guide on page 94 for a comprehensive overview of the range.*

For detailed product specifications, technical drawings, and colour options, scan the QR code for each product to access the online page.





## Key Features

- Premium high-end aesthetic
- Freestanding, Bolt-Down, Floor-to-Wall and Floor-to-Ceiling installation options
- Unique Mode-AL designed columns available in 1.3m or 1.9m heights
- Suitable for landscape or portrait mounting
- Integrated cable management
- Simple 'hook-on' screen installation
- Incorporates System X mounting rails and interface arms
- All components can also be ordered individually
- AV accessories available for VC equipment such as a flip-down media storage tray, shelves and video bars mounts - See Mode-AL mounting guide (page 94)
- Castors (BTW-075-4) for mobility also available separately
- Bolt-Down and Floor-to-Wall installs have a small footprint for a discreet installation in confined areas
- Safety screws help prevent unauthorised screen removal

VC Shelf **BT7863**  
& Adjustable  
Accessory  
Mounting Arm  
**BT8390-SA**

Flip Down Storage Tray **BT7884**

**Available Separately:**  
Accessorise Stands with  
AV Storage Trays & VC Shelves



## BT8700 Floor-To-Wall Single Screen UC Stand

Recommended Max Screen	Max Load	Max VESA	QR Code
75" / 190cm	70kg	600 x 400	



BT7863 & BT8390-SA  
VC Shelf and Adaptor  
available separately

## BT8701 Floor-To-Wall Single Screen UC Stand

Recommended Max Screen	Max Load	Max VESA	QR Code
75" / 190cm	70kg	600 x 400	

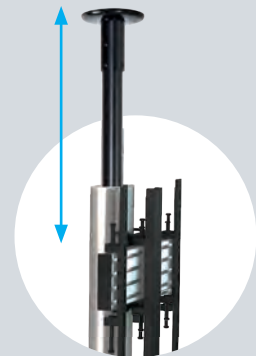

BT8702 pole can be positioned  
to accommodate a range of  
ceiling heights

## BT8702 Floor-To-Ceiling Single Screen UC Stand

Recommended Max Screen	Max Load	Max VESA	QR Code
75" / 190cm	70kg	600 x 400	



### ALSO AVAILABLE...

#### BT7884-TRAY AV Storage Tray

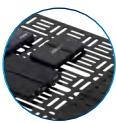

Max Load	QR Code
10kg	

Storage Trays can be quickly released from the BT7884 and changed over with pre-loaded AV equipment easily

### ALSO AVAILABLE...

#### BT7884 Flip-Down AV Storage Tray

An additional BT8390 mounting rail is required to fit the BT7884  
\*Rail size is dependent on size of screen contact B-Tech for details

Max Load	Rotation	QR Code
10kg	90°	

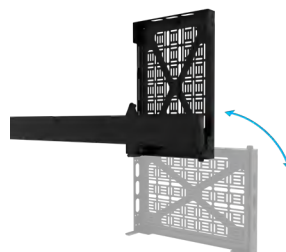



**BT7032 & BT7033**  
AV Component Shelves  
can be added to Mode-AL  
Columns using **BT8385-RTC**

**ALSO AVAILABLE...**

**BTW075-4**  
Braked Castors



**BTW075-4** Braked Castors  
for use with Mode-AL  
freestanding floor bases



**BT8385-SCB & BT8385-TCB**  
alternative freestanding  
floor bases also available

■ **BT8703**  
**Bolt-Down**  
**Single Screen UC Stand**

Recommended Max Screen	Max Load	Max VESA	QR Code
75" 190cm	70kg	600 x 400	



■ **BT8704**  
**Bolt-Down**  
**Single Screen UC Stand**

Recommended Max Screen	Max Load	Max VESA	QR Code
75" 190cm	70kg	600 x 400	



■ **BT8705**  
**Freestanding**  
**Single Screen UC Stand**

Recommended Max Screen	Max Load	Max VESA	QR Code
75" 190cm	70kg	600 x 400	



■ **BT8706**  
**Freestanding**  
**Single Screen UC Stand**

Recommended Max Screen	Max Load	Max VESA	QR Code
75" 190cm	70kg	600 x 400	





■ **BT8707**  
**Floor-To-Wall**  
**Single Screen Twin Column UC Stand**



Recommended Max Screen	Max Load	Max VESA	QR Code
100" 254cm	200kg	800	

■ **BT8708**  
**Bolt-Down**  
**Single Screen Twin Column UC Stand**



Recommended Max Screen	Max Load	Max VESA	QR Code
100" 254cm	140kg	800	

■ **BT8709**  
**Freestanding**  
**Single Screen Twin Column UC Stand**



Recommended Max Screen	Max Load	Max VESA	QR Code
100" 254cm	100kg	800	



Attach **BT7884** Flip Down AV Storage Tray Mounts to **BT8390** Rails



**BTW075-4** Braked Castors are available separately for use with Mode-AL bases

## Mode-AL VC Twin Screen Display Stands



■ **BT8710**  
**Floor-To-Wall**  
**Twin Screen VC Stand**



Recommended Max Screen	Max Load	Max VESA	QR Code
65" 165cm	70kg per screen	600 x 400	



Video bar adaptors available separately see page 104



VC shelves can be fixed above or below screens

## ■ BT8711 Bolt-Down Twin Screen VC Stand

Recommended Max Screen	Max Load	Max VESA	QR Code
65" 165cm	70kg per screen	600 x 400	



## ■ BT8712 Freestanding Twin Screen VC Stand

Recommended Max Screen	Max Load	Max VESA	QR Code
65" 165cm	56kg per screen	600 x 400	



### Mode-AL UC / VC Stands

Model Number	Mount	Recommended Max Screen	Max Load	Max VESA	Lateral Shift	Includes VC Shelf	Number of Screens	Column Height	Dimensions	Colour Options
BT8700	Floor-To-Wall	75"	70kg	600 x 400	✓	N/A	1	1.3M	H.1369mm W.700mm D.165mm	✓
BT8701	Floor-To-Wall	75"	70kg	600 x 400	✓	N/A	1	1.9M	H.1969mm W.700mm D.165mm	✓
BT8702	Floor-To-Ceiling	75"	70kg	600 x 400	✓	N/A	1	1.9M	H.2050mm - 2700mm W.705mm D.210mm	✓
BT8703	Bolt-Down	75"	70kg	600 x 400	✓	N/A	1	1.3M	H.1310mm W.700mm D.210mm	✓
BT8704	Bolt-Down	75"	70kg	600 x 400	✓	N/A	1	1.9M	H.1910mm W.700mm D.210mm	✓
BT8705	Freestanding	75"	70kg	600 x 400	✓	N/A	1	1.3M	H.1342mm W.890mm D.753mm	✓
BT8706	Freestanding	75"	70kg	600 x 400	✓	N/A	1	1.9M	H.1942mm W.890mm D.753mm	✓
BT8707	Floor-To-Wall	100"	200kg	900 x 800	✓	N/A	1	1.9M	H.1969mm W.1000mm D.165mm	✓
BT8708	Bolt-Down	100"	140kg	900 x 800	✓	N/A	1	1.9M	H.1910mm W.1000mm D.210mm	✓
BT8709	Freestanding	100"	100kg	900 x 800	✓	N/A	1	1.9M	H.1942mm W.1128mm D.757mm	✓
BT8710	Floor-To-Wall	65"	70kg Per Screen	600 x 400	✓	✓	2	1.9M	H.1969mm W.2000mm D.165mm	✓
BT8711	Bolt-Down	65"	70kg Per Screen	600 x 400	✓	✓	2	1.9M	H.1910mm W.2000mm D.210mm	✓
BT8712	Freestanding	65"	56kg Per Screen	600 x 400	✓	✓	2	1.9M	H.1942mm W.2000mm D.757mm	✓

## Step 1

Choose **Floor** / **Ceiling** Fixing

### Ceiling Mounts



BT7822



### Floor-To-Wall Mount



BT8385-CTW

### Floor Bases



BT8385-BDB



BT8380-AFB



BT8385-SXB

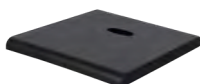

BT8385-SCB



BT8385-TXB

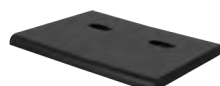

BT8385-TCB

### Braked Castors



Use with BT8385-SXB or BT8385-TXB

BTW075-4

## Step 2

Choose Column / Pole Length

### Ø50mm Poles

#### Standard

- BT7850-050 (0.5m)
- BT7850-100 (1m)
- BT7850-150 (1.5m)
- BT7850-200 (2m)
- BT7850-300 (3m)

#### Heavy-Duty only available in black

- BT7853-200 (2m)
- BT7853-300 (3m)

#### Pole Ring



BT7055



### Floor To Ceiling Mounting Kit



*\*Includes additional column extension kit for combining vertical columns if required.*

BT8385-FTC

### Columns



BT8385-130 (1.3m)

BT8385-190 (1.9m)



# Create a custom Mode-AL display stand in 3 simple steps

Complete off-the-shelf kits are available, but for greater flexibility and convenience components can be supplied individually and used to create custom installations to suit any application.

## Step 3

Choose Mounting Rail, Interface Arms and any additional accessories

### Screen Interface Arms

BT8390-VESA200F

BT8390-VESA400F

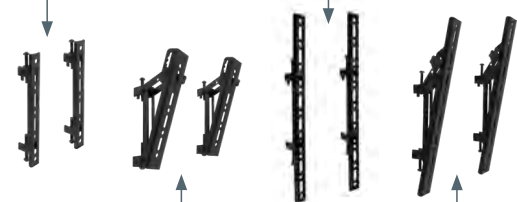

BT8390-VESA200T

BT8390-VESA400T

BT8390-VESA400MAP

BT8390-VESA800F



BT8390-VESA400MAF

BT8390-VESA600F

BT8390-VESA1200F



### Mounting Rails

- BT8390-050 (0.5m)
- BT8390-070 (0.7m)
- BT8390-100 (1m)
- BT8390-150 (1.5m)
- BT8390-175 (1.75m)
- BT8390-200 (2m)



### Joining Kit



BT8385-RTC

### Camera Mount

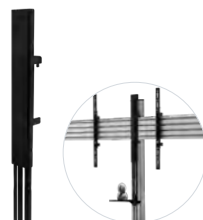

BT8390-SA

### Accessories



BT7863

BT7033

BT7032

## Off-The-Shelf Complete Mode-AL Solutions

### Single Screen

#### Floor-To-Ceiling



BT8702

View the full range now...



#### Floor-To-Wall



BT8700



BT8701



BT8707

### Twin Screen



BT8710

### Bolt-Down



BT8703



BT8704



BT8708



BT8711

### Freestanding



BT8705



BT8706



BT8709



BT8712

### Media Storage / Video Bar Mounts / UC Equipment

BT7871

BT7873

BT7874



BT7884



BT7875



BT7877



BT7878



BT7879

# Media Storage Devices & Shelves



**Storage trays are an ideal solution for discreet mounting of AV equipment, such as power supplies, media players and video conferencing equipment behind a screen.**

Media storage trays are available as a combined screen mount or as separate mounts that can be wall, rail or pole mounted by the side or underneath the screen mount. AV equipment is easily fitted to the removable storage tray using the supplied cable ties for cable management.

B-Tech's range of AV component shelves are a convenient way to mount media equipment onto an installation. The shelves' versatile mounting options mean most can be mounted directly to the wall or onto B-Tech columns or poles (using accessory collars). The shelves can also be mounted above or below the screen using adjustable mounting arms.

For complete product specifications, including technical drawings and colour options, scan the QR code for each product to view the online page.

## **Key Features - Media Storage**

- Designed to hold and hide AV accessories such as media equipment, power supplies, routers and other video conferencing equipment behind a screen
- Options for slide-out or pull-down trays for easy access to media equipment
- Tool-less operation of tray movement
- All accessories can be accessed, removed or added when in the open position without screen removal
- Quick release function of tray so equipment can be easily removed from tray and serviced
- Replacement trays available to order separately
- Compatible with B-Tech's System X and Mode-AL columns and collars for pole-mounted installations





### Media Storage Devices

Discreetly store and hide media equipment behind a screen using replaceable trays

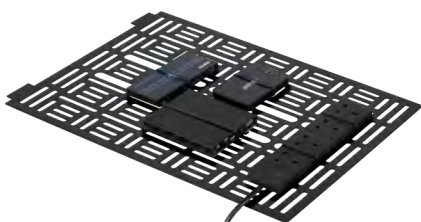

### Key Features - Shelves

- Ideal for mounting VC cameras, media equipment, laptops, game consoles, etc
- Compatible with B-Tech's columns and pole mounting using B-Tech collars
- Use an adjustable mounting arm to install a shelf above or below a mounted screen
- Shelves also mount directly to walls
- Suitable for use with B-Tech's range of flat-screen trolleys and floor stands
- Can be mounted back-to-back on pole set-ups
- All mounting hardware included  
Simple installation

### AV Component Shelves

Mount a range of AV equipment onto stands from a variety of component shelves



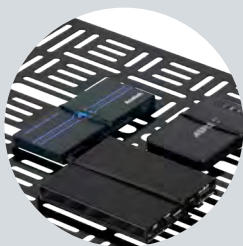

Storage Trays can be quickly released from the **BT7883** and **BT7885** and changed over with pre-loaded AV equipment easily

## BT7883 Flat Screen Wall Mount with Slide-Out AV Storage Tray

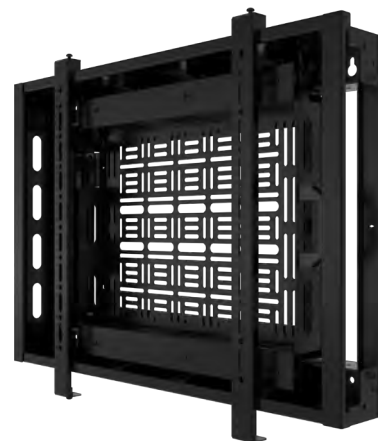
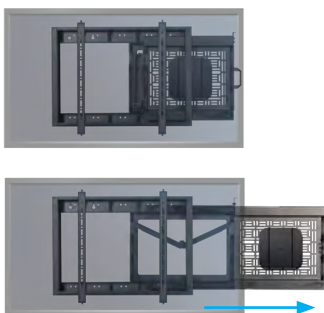

Recommended Max Screen	Max Load Screen	Max Load Tray	Max VESA	QR Code
75" 190cm	70kg	10kg	600 x 400	

Also Available...

### BT7883-TRAY AV Storage Tray

Max Load	QR Code
10kg	

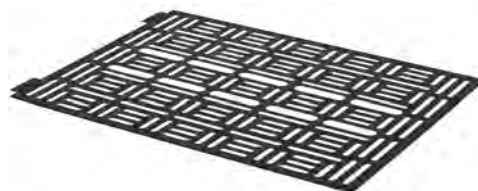

Also Available...

### BT7034 Adjustable Accessory Mounting Arm



Use to adjustable arm to mount accessories (such as shelves or video bar mounting plates) to the **BT7883** or **BT7885**

## BT7885 Flat Screen Wall Mount with Pull-Down AV Storage Tray

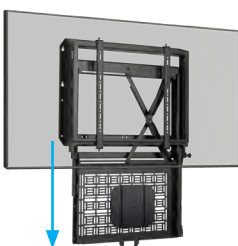

Recommended Max Screen	Max Load Screen	Max Load Tray	Max VESA	QR Code
86" 218cm	70kg	8kg	600 x 400	

Also Available...

### BT7885-TRAY AV Storage Tray

Max Load	QR Code
8kg	

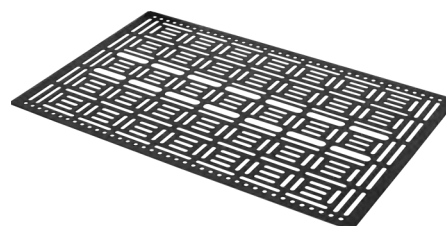



Screen mount supplied separately

## ■ BT7889 Wall Mounted Fixed AV Storage Tray

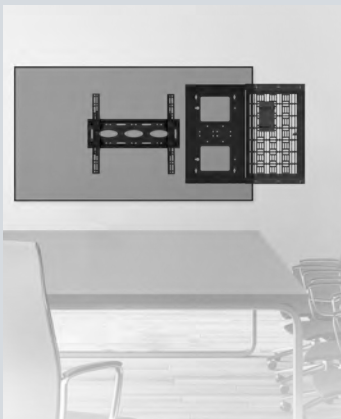
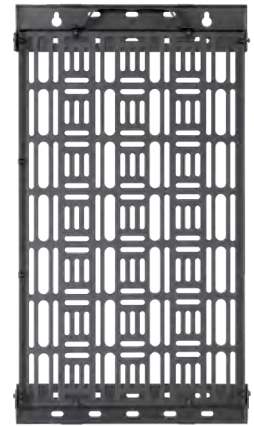
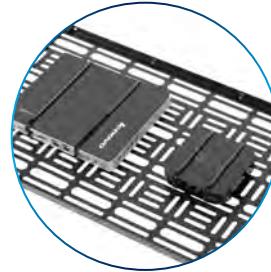

Can be mounted in a portrait or landscape orientation

## ■ BT7888 Wall Mounted Slide-Out AV Storage Tray

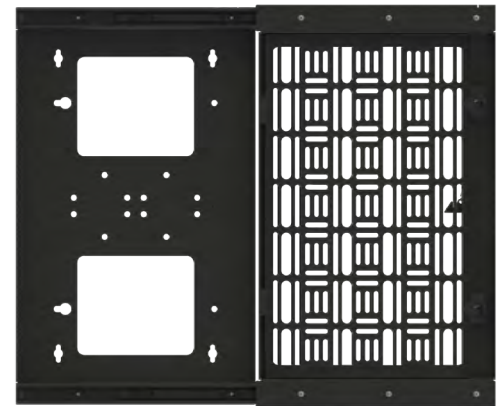

Cradle can be fitted to poles, columns or onto the back of a screen mount

## ■ BT7780 Digital Signage Cradle

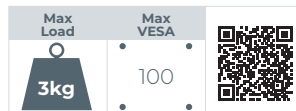

## AV Storage Mounts

Model Number	Recommended Screen Size	Screen Max Weight	Max VESA	AV Equipment Max Load	Max Weight On 1 Pole / Column	Tilt	System X Compatible	System 2 Compatible	Storage Dimensions
BT7883	46"-75"	70kg	600x400	10kg	27kg	N/A	✓	✓	H.424mm W.335mm D.65mm
BT7885	49"-86"	70kg	600x400	8kg	27kg	N/A	✓	✓	H.361mm W.575mm D.60mm
BT7889	N/A	N/A	N/A	10kg	N/A	N/A	✓	N/A	H.450mm W.280mm D.32mm
BT7888	N/A	N/A	N/A	10kg	N/A	N/A	✓	N/A	H.450mm W.280mm D.50mm
BT7780	N/A	N/A	100x100	3kg	N/A	N/A	✓	✓	H.231mm W.231mm D.64mm



**BT7886**  
Mersive® Solstice Pod  
Mounting Cradle

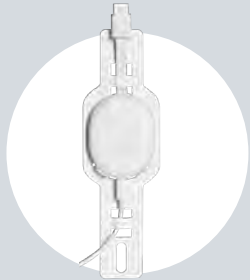

**BT7781**  
Chromecast® Mount

Contact B-Tech to confirm which generation of Chromecast when ordering



## AV Component Shelves



■ **BT7875**  
Small Camera Mounting Plate

Suitable for mounting Yealink UVC40, A20, MeetingEye 400, Poly Studio X30 and Logitech MeetUp VC cameras to a range of B-Tech products



W: 90mm x D: 60mm x H: 63mm

Shelves can attach to poles using accessory collars, directly to columns and to rails or wall mounts using mounting arms

■ **BT7878**  
Camera Mounting Plate

Suitable for mounting Yealink A30 or MeetingEye 600 VC cameras to a range of B-Tech products



W: 100mm x D: 103mm x H: 70mm



**BT7866** designed to mount directly on top of a screen - ideal for webcams

■ **BT7866**  
Camera Shelf with Tilt



AV shelves are ideal for mounting VC cameras

■ **BT7863**  
Small AV Accessory Shelf  
235 x 120mm



Fits most VC cameras with a 1/4" thread



Mount shelves directly to **BT8380 & BT8381** columns



Use accessory collar(s) (**BT7052/BT7841**) to mount onto Ø50mm poles



Use double attachments to increase max load capabilities



**BT7865** Designed to hold a keyboard and mouse

## ■ BT7033 AV Accessory Shelf 300 x 300mm

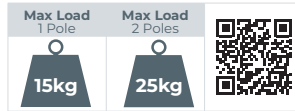

## ■ BT7032 Large AV Accessory Shelf 500 x 380mm

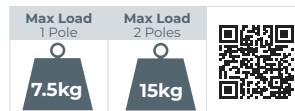

## ■ BT7865 Computer Peripheral Shelf

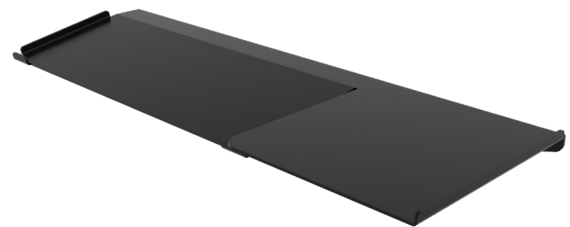

## AV Component Shelves

Model Number	Single Pole / Column Max Load	Twin Pole / Column Max Load	Tilt	System X Compatible	System 2 Compatible	Shelf Dimensions	Colour Options
BT7875	4kg	N/A	N/A	✓	✓	W.60mm x D.60mm	N/A
BT7878	4kg	N/A	N/A	✓	✓	W.100mm x D.103mm	N/A
BT7866	1kg	N/A	+25°	✓	✓	W.122mm x D.106mm	N/A
BT7863	4kg	N/A	N/A	✓	✓	W.120mm x D.235mm	N/A
BT7033	15kg	25kg	N/A	✓	✓	W.300mm x D.300mm	N/A
BT7032	7.5kg	15kg	N/A	✓	✓	W.500mm x D.380mm	N/A
BT7865	4kg	N/A	N/A	✓	✓	W.465mm x D.175mm (keyboard shelf) W.230mm x D.255mm (mouse shelf)	N/A



Use mounting arms to hook shelves and video bar adaptors above or below a screen

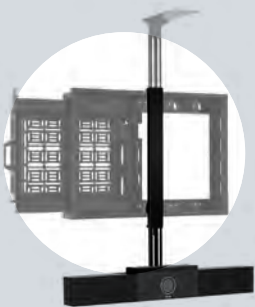

## ■ BT7031 Adjustable Accessory Mounting Arm

Use with compatible B-Tech screen mounts

Adjustable arm mounts a shelf to  
BT8431 / BT8432 / BT8441 / BT8442 / BT9901 / BT9903 /  
BT8504 / BT8506 / BT8572 / BT8573 / BT8582 / BT8583  
screen mounts

Max Load Single	Max Load Pair	QR Code
4kg	15kg	



## ■ BT8390-SA Adjustable Accessory Mounting Arm

Use with System X BT8390 Rails

Adjustable arm mounts a B-Tech shelf to  
products that use a **BT8390** mounting rail

Max Load Single	Max Load Pair	QR Code
4kg	15kg	



## ■ BT7034 Adjustable Accessory Mounting Arm

Use with AV Storage Flat Screen Mounts

Adjustable arm mounts a B-Tech shelf  
to **BT7883 / BT7885** AV Storage Mounts

Max Load Single	Max Load Pair	QR Code
6kg	12kg	





Adjustable clamp, tilt and swivel for optimum speaker mounting and positioning



BTV914 attaches onto a screen mount above or below the screen

## BT77 Side-Clamping Speaker Wall Mounts with Tilt & Swivel (Pair)

Max Load	Tilt	Swivel	QR Code
25kg	10° 10°	360°	



## BTV914 Universal Soundbar Mount

Max Load	QR Code
10kg	



## Speaker Mounts

Model Number	Mount	Supplied In Pairs (for 2 Speakers)	Max Load	Tilt	Swivel	Lateral Adjustment	Height Adjustment	Clamp Size	System 2 Compatible	Colour Options
BT77	Wall	<input checked="" type="checkbox"/>	25kg	+/-10°	360°	N/A	N/A	135-280mm	<input checked="" type="checkbox"/>	<input checked="" type="checkbox"/>
BTV914	Screen	N/A	10kg	N/A	N/A	112mm	250mm	N/A	N/A	N/A

# UC / Video Conferencing Video Bar & Camera Mounts



Off-the-shelf mounts and bespoke adaptors are available for mounting a wide range of UC Equipment, such as Video Bars, Soundbars, Video Conferencing Cameras, etc.

Install video bars on existing B-Tech mounts above or below the screen using Accessory Mounting Arms (BT7031 / BT7034 / BT8390-SA), accessory collars (BT7052 / BT7841) for pole mounting or fix onto columns (BT8380 / BT8381). Solutions are available for most manufacturers.

Solutions available for all major brands, including:



For the most up-to-date brand listings visit B-Tech's website or contact us at [technical@btechavmounts.com](mailto:technical@btechavmounts.com)





**Mount directly to  
B-Tech Columns  
(BT8380 / BT8381)**



**Mount onto a  
BT8390 Rail  
using a BT8390-SA  
Mounting Arm**



**Position above or  
below a wall mounted  
screen using BT7031  
Mounting Arm**



**Mount to a Ø50mm  
Pole using a B-Tech  
Accessory Collar  
(BT7052 / BT7841)**



Mounts to the rear of the screen



Mount onto columns, rails, poles & mounting arms



## ■ BT7870 Universal Conferencing Mount



## ■ BT7871 Video Bar Mounting Plate



## ■ BT7873 Video Bar Mounting Plate



## ■ BT7874 Video Bar Mounting Plate



## ■ BT7875 Video Bar Mounting Plate





## ■ BT7876 Video Bar Mounting Plate



Mounts to the rear of the screen

## ■ BT7877 Video Bar Mounting Plate



## ■ BT7878 Video Bar Mounting Plate



## ■ BT7879 Video Bar Mounting Plate



## Video Bar Mounts

Model Number	Video Bar / Camera	Max Load	System X Compatible	System 2 Compatible	Dimensions
BT7870	Bose Videobar VB-S / Cisco Webex Room Kit Plus Jabra Panacast 50 Logitech Rally Bar / Rally Plus / Huddle / MeetUp Maxhub UC / Neat.Bar / Bar Pro Predia Connect / Poly Studio X30 / X50 / X70 Yealink MeetingEye / MspeakerII / UVC30 / UVC40	10kg	N/A	N/A	900mm x 480-538mm
BT7871	Jabra Panacast 50 / Poly Studio / X50 / X70 Lenovo ThinkSmart 180	3kg	✓	✓	185mm x 75mm
BT7873	Logitech Rally Bar / Logitech Rally Bar Mini	8kg	✓	✓	440mm x 30mm
BT7874	Logitech Rally Plus / Aver VB342PRO Cisco Webex Room Kit Plus	5kg	✓	✓	740mm x 30mm
BT7875	Yealink UVC40 / A20 / Yealink MeetingEye 400 Logitech MeetUp / Poly Studio X30	4kg	✓	✓	90mm x 63mm x 60mm
BT7876	Lenovo Google Series One Medium Room Lenovo Google Series One Large Room Kits	10kg	N/A	N/A	1506mm - 449mm
BT7877	Neat.Bar / Bar Pro Bose Videobar VB1 / VB-S / MspeakerII Logitech Rally Plus Speakers (2 pcs required)	3kg	✓	✓	250mm x 40mm
BT7878	Yealink A30 / MeetingEye 600	4kg	✓	✓	100mm x 103mm x 70mm
BT7879	Biamp Parlé VBC / ABC 2500 / SBC 2 Lenovo ThinkSmart One	5kg	✓	✓	565mm x 70mm

# Projector Ceiling Mounts



**Offering a wide selection of mounts to suit a variety of projector sizes and types, from home projection right up to large scale models used for entertainment venues and projection mapping.**

B-Tech projector mounts are designed to fit quickly, be easily installed, and can be ordered for installation directly to the ceiling or with fixed or height-adjustable ceiling drops. Projector ceiling mounts suitable for installation onto angled ceilings are available. A selection of models are compatible with the System 2 range for customising solutions, such as when extra high ceilings require a much more significant ceiling drop. The unique 'carousel' mounting plate design featured on several products is for universal compatibility and micro-adjustment features, allowing easy positioning of mounted projectors for a perfectly aligned projected image.

For full specifications, including colour options, scan the product's QR code to visit the online pages.

## Key Features

- Options to mount directly to the ceiling for a flush installation or onto a pole for an extended drop
- Compatible with the B-Tech System 2 Professional Range and 1.5" NPT pipe systems
- Pre-assembled for simple three-step installation
- Micro-adjustment for short throw projectors
- Integrated cable management for a smart installation
- Unique 'carousel' mounting plate for universal compatibility
- Supplied with universal fixings suitable for most projectors using M2.5, M3, M4, M5 and M6 fixings
- All mounting hardware included



## Ceiling Drop Options

### Adjustable Drop (AD)

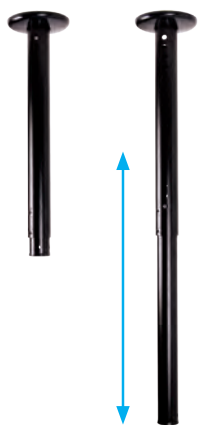

Tool-less adjustable drop  
in 25mm increments

### Fixed Drop (FD)



Multiple pole lengths



### Cable Management

Integrated cable management allows cables to pass through the poles and exit via the ceiling plate



### Mounting Options

Tilting ceiling plate suitable for angled ceilings supplied with fixed drop mounts



### Universal Mounting

Carousel mount design with adjustable extension legs to fit most projectors

**BT899**  
Projector  
Ceiling Mount  
with Micro-Adjustment



Max Load	Yaw	Pitch	Roll	QR Code
25kg	360°	-13° +13°	-6° +6°	

**BT899-AD**  
Adjustable Drop  
Projector Ceiling Mount  
with Micro-Adjustment



Max Load	Yaw	Pitch	Roll	QR Code
25kg	360°	-13° +13°	-6° +6°	

**BT899-FD**  
Fixed Drop  
Projector Ceiling Mount  
with Micro-Adjustment



Available in 5 pole lengths

BT899-FD050	0.5m Pole
BT899-FD100	1m Pole
BT899-FD150	1.5m Pole
BT899-FD200	2m Pole
BT899-FD300	3m Pole

Max Load	Yaw	Pitch	Roll	QR Code
25kg	360°	-13° +13°	-6° +6°	

**BT899XL**  
XL Projector  
Ceiling Mount  
with Micro-Adjustment



Max Load	Yaw	Pitch	Roll	QR Code
25kg	360°	-13° +13°	-6° +6°	

**BT899XL-AD**  
Adjustable Drop XL  
Projector Ceiling Mount  
with Micro-Adjustment



Max Load	Yaw	Pitch	Roll	QR Code
25kg	360°	-13° +13°	-6° +6°	

**BT899XL-FD**  
Fixed Drop XL  
Projector Ceiling Mount  
with Micro-Adjustment



Available in 5 pole lengths

BT899XL-FD050	0.5m Pole
BT899XL-FD100	1m Pole
BT899XL-FD150	1.5m Pole
BT899XL-FD200	2m Pole
BT899XL-FD300	3m Pole

Max Load	Yaw	Pitch	Roll	QR Code
25kg	360°	-13° +13°	-6° +6°	

■ **BT893**  
Heavy Duty  
Projector Ceiling Mount  
with Micro-Adjustment

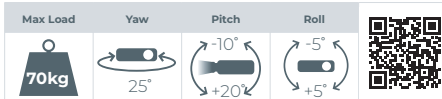

**Precision micro-adjustment with thumbwheels**



■ **BT893-AD**  
Adjustable Drop Heavy Duty  
Projector Ceiling Mount  
with Micro-Adjustment

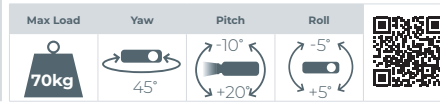

■ **BT893-FD**  
Fixed Drop Heavy Duty  
Projector Ceiling Mount  
with Micro-Adjustment



Available in 5 pole lengths

BT893-FD050	0.5m Pole
BT893-FD100	1m Pole
BT893-FD150	1.5m Pole
BT893-FD200	2m Pole
BT893-FD300	3m Pole

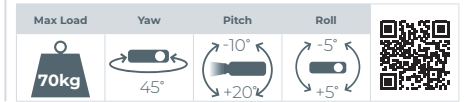

## Projector Ceiling Mounts

Model Number	Max Load	Max Fixings	Roll	Swivel Yaw	Tilt Pitch	Micro-Adjustment Tilt	Optional Extension Legs	Tool-Less Ceiling Drop Adjustment	Ceiling Drop	System 2 Compatible
BT899	25kg	370mm	+/-6°	360°	+/-13°	N/A	N/A	N/A	122mm	<input checked="" type="checkbox"/>
BT899-AD	25kg	370mm	+/-6°	360°	+/-13°	N/A	N/A	<input checked="" type="checkbox"/>	743-1143mm	N/A
BT899-FD	25kg	370mm	+/-6°	360°	+/-13°	N/A	N/A	N/A	0.5M / 1M 1.5M / 2M / 3M	N/A
BT899XL	25kg	493mm	+/-6°	360°	+/-13°	N/A	<input checked="" type="checkbox"/>	N/A	98.5mm	<input checked="" type="checkbox"/>
BT899XL-AD	25kg	493mm	+/-6°	360°	+/-13°	N/A	<input checked="" type="checkbox"/>	<input checked="" type="checkbox"/>	728-1128mm	N/A
BT899XL-FD	25kg	493mm	+/-6°	360°	+/-13°	N/A	<input checked="" type="checkbox"/>	N/A	0.5M / 1M 1.5M / 2M / 3M	N/A
BT893	70kg	873mm	+/-5°	25°	+20° / -10°	+/-5°	<input checked="" type="checkbox"/>	N/A	153mm	<input checked="" type="checkbox"/>
BT893-AD	70kg	873mm	+/-5°	45°	+20° / -10°	+/-5°	<input checked="" type="checkbox"/>	<input checked="" type="checkbox"/>	766-1186mm	N/A
BT893-FD	70kg	873mm	+/-5°	45°	+20° / -10°	+/-5°	<input checked="" type="checkbox"/>	N/A	0.5M / 1M 1.5M / 2M / 3M	N/A

■ Small / Medium ■ Large ■ Extra Large

# Audipack Mounting Solutions

GM|G  
GLOBAL MOUNTS GROUP

In 2024 Global Mounts Group acquired Audipack, a renowned manufacturer of high-end and tailor-made mounting solutions. For over 40 years Audipack have developed a wide range of specialist AV products such as projector and flat screen mounting accessories, flight cases and electronic lift systems. Catering for indoor or outdoor environments and with a strong focus on the rental market, the addition of Audipack to the Global Mounts Group expands our product offering even further. On these pages you will find some examples of the types of products that Audipack specialise in. If you are interested in these types of solutions, please do get in touch.



## Rental Floor Stands for Flat Screens

Combining style with strength, Audipack floor stands are easy on the eye and easy to install.

Redefining flexibility, quick installation and installer friendliness, Audipack 700, 800 and 900 series floor stands feature a Lock & Secure quick mounting system, access hatches for cabling and can be fitted into Audipack flight cases to create the ultimate rental floor stand solution.



## Totems/Kiosks for Outdoor Screens

FOD totems are a rigid kiosks specially designed for installing a full outdoor screen. The all weatherproof outdoor display, safely conceals your signage equipment and keeps it protected against theft and environmental surroundings. Solutions available for single, back-to-back and side-by-side displays. A range of indoor kiosks are also available.



## Outdoor Housing for Flat Screens

FSMO outdoor housing for wall mounting screens in open and public areas. Standard and slimline enclosures are available for screens from 32" up to 86" with separate designs for landscape and portrait mounting. The housing is equipped with thermostatically controlled heating and ventilation.

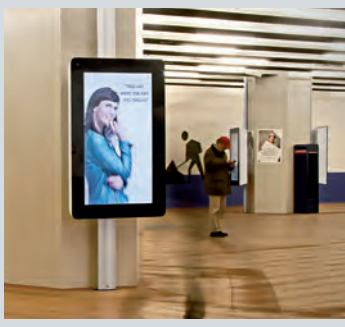

## Indoor Housing for Flat Screens

FSMT indoor housing for wall mounting screens in public areas. Standard and slim-line enclosures are available for screens from 32" up to 86" with solutions for landscape or portrait mounting. The housing features protective anti-theft security and is supplied with fully removable front and hardened glass to protect the display.





## Automatically raise your large screen out of the flightcase



### Rental solutions for large and heavy screens

These dividable floor stands create a compact system that can be easily transported together with a flat panel, all in one flight case.

The simple to assemble parts create a rigid and pleasing floor stand that lifts the flat panel effortlessly out of the flight case and raises it up to the presentation position – all automatically. Ideal for large and heavy screens, including touchscreens.

## Custom LED Solutions

**Audipack fabricates custom pop-up, foldable solutions with electronic height adjustment.**

The LSW-T series for LED cabinet transportation and presentation for LED walls up to 200". Boasting a minimalistic wheelframe with an integrated motor drive that lifts the LED display to the perfect height, easily adapts to various LED brands and sizes.

Optional: Combine stand with a custom flight case



## Liftomatic® Rental Systems

**Audipack engineers and manufactures custom rental systems for the easy transportation and set up of LED walls.**

FLM flightcases have a built-in telescopic lift system that accommodates screens up to 100". With just the push of a button your screen rises to a presentation height of 1800mm (centre of screen). The flightcase also features a large accessory compartment.



## Stack & Rigging Frames for Projectors

**The Audipack stack frame series is ideal for projectors in rental and staging applications.**

The PSF series feature strong, aluminium, lightweight construction with an adjustable bottom frame, allowing the projector to be lined up to the screen with high accuracy. Multiple frames can be easily connected and stacked. The stack-frames are available in standard and custom sizes on request.



## Ceiling Lift Systems for Projectors

**The Audipack projector lift systems have a reputation as durable systems for lowering a projector from the ceiling.**

The PCL ceiling lift systems are the perfect solution for integrating projectors into ceilings, the lift moves precisely to its pre-set position with an extended drop available for servicing, ideal for boardrooms, home cinemas, auditoriums and conference halls etc.



# Component Ranges for Custom Solutions

**B-Tech Component ranges** are modular based systems designed to create custom solutions to suit almost any application. The adaptability of System X, System 2, System V, and our Floor Stand Range allows for an almost endless number of mounting configurations. Our range of components includes freestanding or mobile bases, an extensive selection of wall and ceiling mounts, and various screen interface arms. Flat screen mounts that feature the collar-compatible icon can be fitted to our System 2 poles and System X columns to create floor stands and ceiling mounts. System X can also be used with System 2 poles for specialist ceiling requirements. Enhance installations with additional equipment options, such as AV shelves, media players, or smaller screens.



## Quick Mounting Guides

View the **Component guides:** starting Pg.122

For installations where customisability is not required, see our **Complete Mounting Solutions and Kits** starting on **page 10**.



SYSTEM X

Pg.116

### Multi-Screen Mounting System

Videowalls, Menu Boards  
and Specialist Screen Solutions



SYSTEM 2™

Pg.132

### Ø50mm Pole Mounted Installs

Ceiling, Wall and Floor-To-Ceiling Applications

# Component Ranges for Custom Solutions

Component parts are individual off-the-shelf products that fit together like a giant Meccano set. This allows custom mounting solutions to be built in an almost endless number of configurations.



Wall Mounts



Ceiling Mounts



Floor Bases



Poles and Columns



Screen Interfaces



Accessories

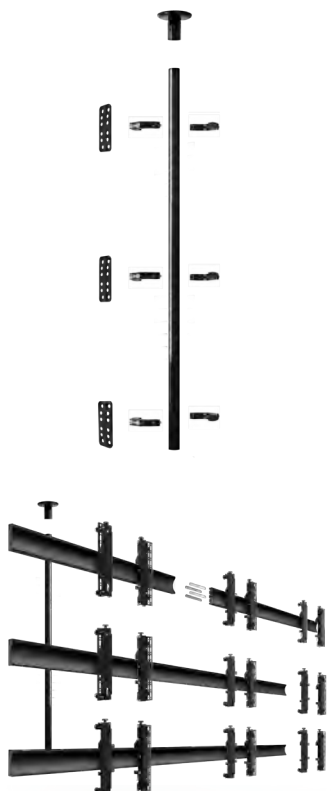

SYSTEM X  
SYSTEM 2™

Pg.124

## System X and System 2 Combined

For unlimited mounting possibilities



Pg.146

## Floor Stand Components

Create and build floor stands to your requirements



Pg.152

## SYSTEM V™

## Components and Complete Mounting Kits

Security mounting solutions

## Component Range



### **The System X range is a premium component based system designed for professional AV installations.**

Ideal for multi-screen displays, a comprehensive selection of mounts and components are available for wall, floor and ceiling installations. For greater flexibility and convenience, components are supplied individually to create custom installations to suit almost any application.

The range works on a modular principle using extruded aluminium rails and columns to fix displays to the wall or floor. System X also utilises System 2's pole and collar mounts for ceiling or specialist installations. Rails and columns can be extended using extension kits and a selection of interface arms are available to choose from depending on the type of screen and type of installation. Accessories have been designed to provide a tidy solution for almost any install requirement.

View the guides on the following pages for a complete overview of System X mounting possibilities. For complete product specifications, including technical drawings, scan the QR codes for each product to visit the online page.



### Multi Screen Floor Stands



### Videowalls



### Custom Solutions



## SYSTEM X

### Quick-Start Guide: 3x2 Wall Mounted Videowall installation

This quick start guide demonstrates the steps to create a wall-mounted 3x2 video wall installation with an added camera shelf using the System X range. Follow the listed steps to create the ideal bespoke installation for your mounting needs. Start with the basics and add additional devices, such as screens or accessories, as desired.

For more information or to see how the range can be used in alternative installations, please get in touch with us at [technical@btechavmounts.com](mailto:technical@btechavmounts.com)

### Created from the following B-Tech Components

- x6 **BT8390-WFK1** Wall Fixing Kit
- x2 **BT8390-200** Horizontal Mounting Rail
- x2 **BT8390-070** Horizontal Mounting Rail
- x2 **BT8390-EXT** Rail Extension Kit
- x6 **BT8390-VESA400MAP** Interface Arms
- x1 **BT8390-SA** Adjustable Mounting Arm
- x1 **BT7863** Small Component Shelf

## MULTI-SCREEN WALL INSTALLATIONS

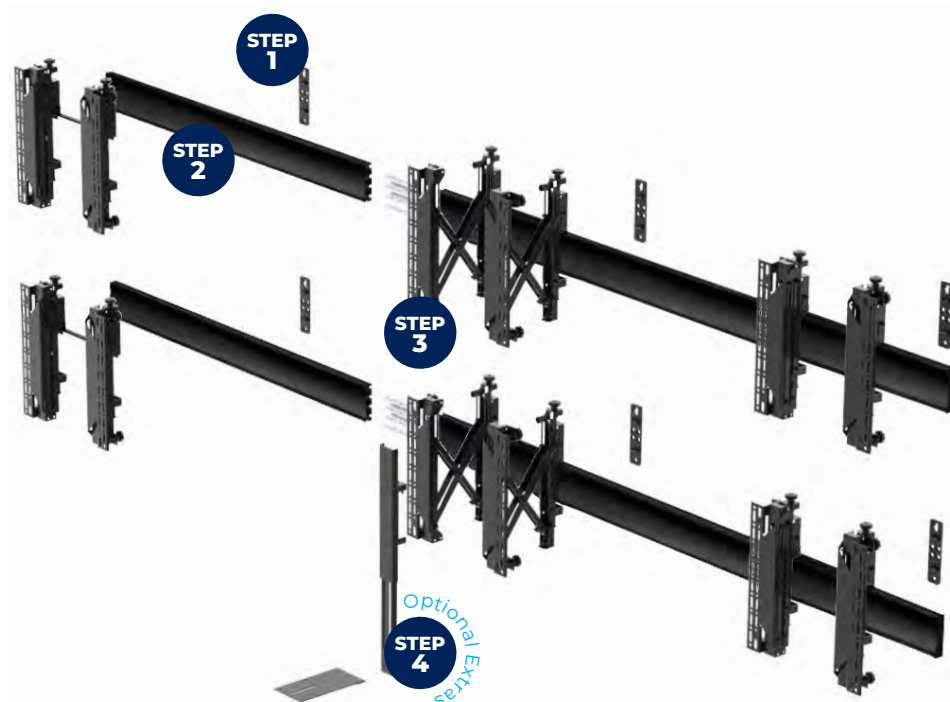

### Step 1:

Choose a Wall Fixing Kit

#### WALL FIXING KITS

PRODUCT CODE	DESCRIPTION
BT8390-WFK1 (pictured)	Rail Fixing Kit
BT8390-WFK2	Rail Fixing Kit
BT8390-WFK3	Twin Rail Fixing Kit
BT8390-WFK4	Horizontal Rail Fixing Kit
BT8390-WFK5	Adj. Depth Rail Fixing Kit
BT8390-WFK6	Adj. Depth & Height Rail Fixing Kit



### Step 2:

Choose a Mounting Rail

#### MOUNTING RAILS

PRODUCT CODE	LENGTH*
BT8390-050	0.5m
BT8390-070 (pictured)	0.7m
BT8390-100	1m
BT8390-150	1.5m
BT8390-175	1.75m
BT8390-200 (pictured)	2m

\*Rail Extension Kits can be used to extend rails, simply select an additional rail to be joined after selecting the joiner below

#### JOINER

PRODUCT CODE	DESCRIPTION
BT8390-EXT (pictured)	Rail Extension Kit

### Step 3:

Choose Interface Arms

#### SCREEN MOUNTING ARMS

PRODUCT CODE	DESCRIPTION	VESA*
BT8390-VESA200F	Fixed Interface Arms	200
BT8390-VESA200T	Interface Arms with Tilt	200
BT8390-VESA400F	Fixed Interface Arms	400
BT8390-VESA400T	Interface Arms with Tilt	400
BT8390-VESA400MAF	Interface Arms with Micro-Adjustment	400
BT8390-VESA400MAP (pictured)	Pop-Out Interface Arms with Micro-Adjustment	400
BT8390-VESA600F	Fixed Interface Arms	600
BT8390-VESA800F	XL Fixed Interface Arms	800
BT8390-VESA1200F	XXL Fixed Interface Arms	1200

\*VESA dimensions refer to the vertical fixings. Interface Arms can be horizontally positioned anywhere along the rail

### Step 4: (if required)

Add Accessories

#### SHELVES AND ADAPTORS

PRODUCT CODE	DESCRIPTION
BT8390-SA (pictured)	Adjustable Mounting Arm
BT7863 (pictured)	Small AV Shelf
BT7032	Medium AV Shelf
BT7033	Large AV Shelf
BT7871 / BT7873 / BT7874 / BT7875 / BT7877 / BT7878 / BT7879	Video Bar Mounting Plate
BT7884	Flip-Down AV Storage Tray
BT7888	Fixed Storage Tray



## Quick-Start Guide: 3x3 Floor-to-Ceiling Videowall installation

This quick start guide demonstrates the steps to create a ceiling-to-floor 3x3 video wall installation using the System X and System 2 range. Follow the listed steps to create the ideal bespoke installation for your mounting needs. Start with the basics and add additional devices, such as screens or accessories, as desired.

For more information or to see how the range can be used in alternative installations, please get in touch with us at [technical@btechavmounts.com](mailto:technical@btechavmounts.com)

## MULTI-SCREEN FLOOR-TO-CEILING INSTALLATIONS

Created from the following  
**B-Tech Components**

- x4 **BT7822** Ceiling Mount
- x2 **BT7850-150** Ø50mm Pole
- x6 **BT8390-CFK** Collar Mounting Kit
- x3 **BT8390-200** Horizontal Mounting Rail
- x12 **BT7052** Ø50mm Accessory Collar
- x9 **BT8390-VESA400MAF** Interface Arms
- x2 **BT7850-200** Ø50mm Pole
- x2 **BT7823** Internal Pole Joiner

### Step 1:

Choose a Ceiling Mount

#### WALL FIXING KITS

PRODUCT CODE	DESCRIPTION
BT7807	Twin Pole Ceiling Mount
BT7808	Ceiling Mount with Tilt
BT7822 (pictured)	Ceiling Mount

#### SPECIALIST MOUNTS

BT7012	Purlin Mount
BT7017	I-Beam (Girder) Mount
BT7825	Truss Clamp
BT7831	Wall Mounting Bracket

### Step 2:

Choose a Ø50mm Pole

#### POLES

PRODUCT CODE	LENGTH*
BT7850-050	0.5m
BT7850-100	1m
BT7850-150 (pictured)	1.5m
BT7850-200 (pictured)	2m
BT7850-300	3m

\*To extend poles, choose a joiner listed below and an additional pole to fit to.

#### POLE JOINERS

PRODUCT CODE	DESCRIPTION
BT7823 (pictured)	Internal Pole Joiner
BT7824	External Pole Joiner

### Step 3:

Choose a Floor Fixing

#### FLOOR BASES

PRODUCT CODE	DESCRIPTION
BT7056	Floor Fixing Kit
BT7807	Twin Pole Floor / Ceiling Mount
BT7822 (pictured)	Single Pole Floor / Ceiling Mount
BT7831	Wall Mounting Bracket



### Step 4:

Choose a Collar Fixing Kits and Collars

PRODUCT CODE	DESCRIPTION
<b>COLLAR FIXING KITS</b>	
BT8390-CFK	Collar Fixing Kit

#### COLLARS

BT7051	Heavy-Duty Accessory Collar
BT7052 (pictured)	Accessory Collar
BT7841	2-Piece Accessory Collar

### Step 5:

Choose a Mounting Rail

#### MOUNTING RAILS

PRODUCT CODE	LENGTH*
BT8390-050	0.5M
BT8390-070	0.7m
BT8390-100	1m
BT8390-150	1.5m
BT8390-175	1.75m
BT8390-200 (pictured)	2m

\*BT8390-EXT can be used to extend rails

### Step 6:

Choose Interface Arms

#### SCREEN MOUNTING ARMS

PRODUCT CODE	DESCRIPTION	VESA*
BT8390-VESA200F	Fixed Interface Arms	200
BT8390-VESA200T	Interface Arms with Tilt	200
BT8390-VESA400F	Fixed Interface Arms	400
BT8390-VESA400T	Interface Arms with Tilt	400
BT8390-VESA400MAF (pictured)	Interface Arms with Micro-Adjustment	400
BT8390-VESA400MAP	Pop-Out Interface Arms with Micro-Adjustment	400
BT8390-VESA600F	Fixed Interface Arms	600
BT8390-VESA800F	XL Fixed Interface Arms	800
BT8390-VESA1200F	XXL Fixed Interface Arms	1200

\*VESA dimensions refer to the vertical fixings. Interface Arms can be horizontally positioned anywhere along the rail

## SYSTEM X

### Quick-Start Guide: x10 Screen Curved Portrait Videowall Floor Stand

This quick-start guide demonstrates creating a freestanding x10 screen curved videowall mounting solution using the System X component range. Follow the listed steps to create a bespoke solution to your requirements. Start with the essentials and add additional devices, such as screens or accessories, as desired.

For more information or to see how the range can be used in alternative installations, please get in touch with us at [technical@btechavmounts.com](mailto:technical@btechavmounts.com)

## CONTROL ROOM INSTALLATIONS



### Created from the following B-Tech Components

- x6 **BT8380-BASE** Freestanding Floor Base
- x6 **BT8380** Vertical Column
- x6 **BT8390-WFK3** Rail Fixing Kit
- x10 **BT8390-100** Horizontal Mounting Rail
- x8 **BT8390-AAC** Angle Adjustment Connector
- x10 **BT8390-VESA800F** Interface Arms

### Step 1:

Choose a Floor Base

FLOOR BASES	
PRODUCT CODE	DESCRIPTION
BT8380-BASE <i>(pictured)</i>	Freestanding Base*
BT8380-SHB	Short Freestanding Base
BT8380-FFB	Freestanding Base
BT8380-FSB	Freestanding Base
BT8380-AFB	Adjustable Levelling Base

\*Use **BT8380-CASTORS** to create a mobile stand

CASTORS	
PRODUCT CODE	DESCRIPTION
BT8380-CASTORS	4" Braked Castors

### Step 2:

Choose a Column

VERTICAL COLUMNS	
PRODUCT CODE	LENGTH*
BT8380-180 <i>(pictured)</i>	1.8m
BT8380-060	0.6m

COLUMN EXTENSION KIT	
PRODUCT CODE	DESCRIPTION
BT8380-EXTV	Column Extension Kit

\*Use Extension Kits create taller installations

### Step 3:

Add Rail-to-Column Joiner

RAIL-TO-COLUMN JOINER	
PRODUCT CODE	DESCRIPTION
BT8380-JPK	Rail-to-Column Joiner
BT8380-JPT	Rail-to-Column Joiner with Tilt
BT8380-WFK3 <i>(pictured)</i>	Twin Rail-to-Column Joiner

### Step 4:

Choose a Mounting Rail

MOUNTING RAILS	
PRODUCT CODE	LENGTH*
BT8390-050	0.5m
BT8390-070	0.7m
BT8390-100 <i>(pictured)</i>	1m
BT8390-150	1.5m
BT8390-175	1.75m
BT8390-200	2m

\*Rail Extension Kits can be used to extend rails, simply select an additional rail to be joined after selecting the joiner below

### Step 5:

Add Rail Connector

RAIL CONNECTOR	
PRODUCT CODE	DESCRIPTION
BT8390-EXT	Rail Extension Kit
BT8390-AAC <i>(pictured)</i>	Angle Adjustment Connector

### Step 6:

Choose Interface Arms

SCREEN MOUNTING ARMS			
PRODUCT CODE	DESCRIPTION	VESA*	
BT8390-VESA200F	Fixed Interface Arms	200	
BT8390-VESA200T	Interface Arms with Tilt	200	
BT8390-VESA400F	Fixed Interface Arms	400	
BT8390-VESA400T	Interface Arms with Tilt	400	
BT8390-VESA400MAF	Interface Arms with Micro-Adjustment	400	
BT8390-VESA400MAP	Pop-Out Interface Arms with Micro-Adjustment	400	
BT8390-VESA600F	Fixed Interface Arms	600	
BT8390-VESA800F <i>(pictured)</i>	XL Fixed Interface Arms	800	
BT8390-VESA1200F	XXL Fixed Interface Arms	1200	

\*VESA dimensions refer to the vertical fixings. Interface Arms can be horizontally positioned anywhere along the rail

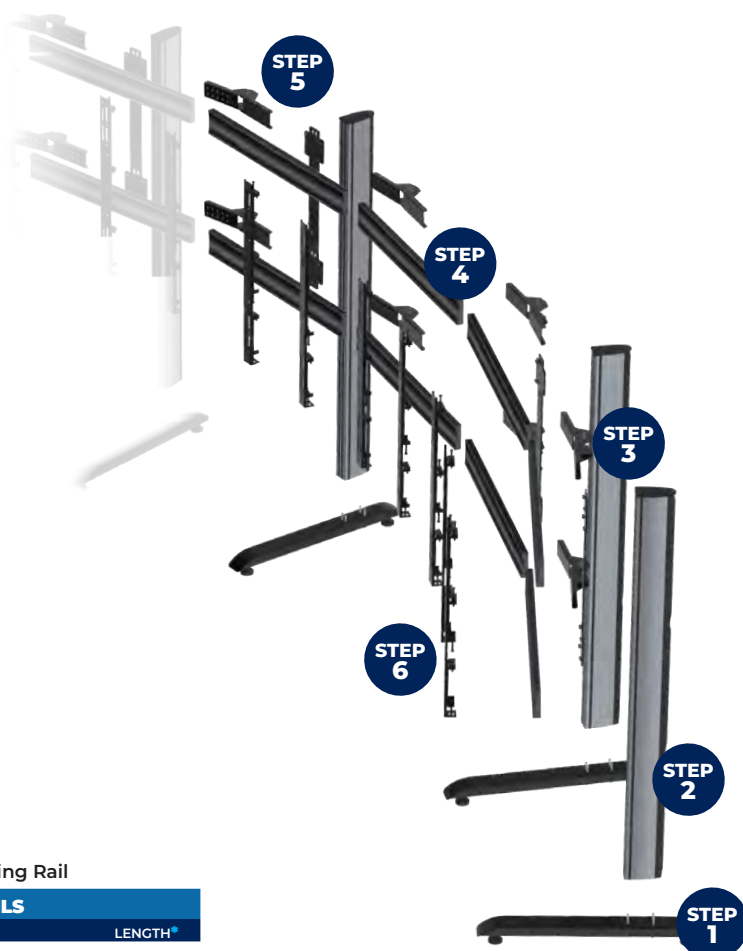



## SYSTEM X

### Quick-Start Guide: Multi-Screen Bolt-Down Media Wall Floor Stand with Tilt

This quick start guide demonstrates the steps taken to create multi-screen installations ideal for broadcast rooms where various-sized screens and set-ups are required. Follow the listed steps to create the perfect bespoke installation for your mounting needs. Start with the basics and add additional devices, such as screens or accessories, as desired.

For more information or to see how the range can be used in alternative installations, please get in touch with us at: [technical@btechavmounts.com](mailto:technical@btechavmounts.com)

## BROADCAST INSTALLATIONS

Created from the following B-Tech Components

- x4 **BT8380-FFB** Bolt-Down Floor Base
- x4 **BT8380** Vertical Column
- x4 **BT8380-JPK** Rail-to-Column Joining Kit
- x4 **BT8380-JPT** Rail-to-Column Joining Kit with Tilt
- x4 **BT8390-175** Mounting Rail
- x2 **BT8390-EXT** Rail Extender Kit
- x4 **BT8390-VESA200T** VESA 200 Interface Arms
- x4 **BT8390-VESA400T** VESA 400 Interface Arms
- x1 **BT77** Speaker Mount
- x2 **BT7032** AV Component Shelf



### Step 1:

Choose a Floor Base

FLOOR BASES	
PRODUCT CODE	DESCRIPTION
BT8380-BASE	Freestanding Base*
BT8380-SHB	Short Freestanding Base
BT8380-FFB <i>(pictured)</i>	Bolt-Down Floor Base
BT8380-FSB	Freestanding Base
BT8380-AFB	Adjustable Levelling Base

\*Use **BT8380-CASTORS** to create a mobile stand

CASTORS	
PRODUCT CODE	DESCRIPTION
BT8380-CASTORS	4" Braked Castors

### Step 2:

Choose a Column

VERTICAL COLUMNS	
PRODUCT CODE	LENGTH*
BT8380-180 <i>(pictured)</i>	1.8m
BT8380-060	0.6m

COLUMN EXTENSION KIT	
PRODUCT CODE	DESCRIPTION
BT8380-EXTV	Column Extension Kit

\*Use Extension Kits create taller installations

### Step 3:

Add Rail-to-Column Joiner

RAIL-TO-COLUMN JOINER	
PRODUCT CODE	DESCRIPTION
BT8380-JPK <i>(pictured)</i>	Rail-to-Column Joiner
BT8380-JPT <i>(pictured)</i>	Rail-to-Column Joiner with Tilt
BT8380-WFK3	Twin Rail-to-Column Joiner

### Step 4:

Choose a Mounting Rail

MOUNTING RAILS	
PRODUCT CODE	LENGTH*
BT8390-050	0.5m
BT8390-070	0.7m
BT8390-100 <i>(pictured)</i>	1m
BT8390-150	1.5m
BT8390-175	1.75m
BT8390-200	2m

\*Rail Extension Kits can be used to extend rails, simply select an additional rail to be joined after selecting the joiner below

JOINER	
PRODUCT CODE	DESCRIPTION
BT8390-EXT <i>(pictured)</i>	Rail Extension Kit



### Step 5:

Choose Interface Arms

SCREEN MOUNTING ARMS		
PRODUCT CODE	DESCRIPTION	VESA*
BT8390-VESA200F	Fixed Interface Arms	200
BT8390-VESA200T <i>(pictured)</i>	Interface Arms with Tilt	200
BT8390-VESA400F <i>(pictured)</i>	Fixed Interface Arms	400
BT8390-VESA400T	Interface Arms with Tilt	400
BT8390-VESA400MAF	Interface Arms with Micro-Adjustment	400
BT8390-VESA400MAP	Pop-Out Interface Arms with Micro-Adjustment	400
BT8390-VESA600F	Fixed Interface Arms	600
BT8390-VESA800F	XL Fixed Interface Arms	800
BT8390-VESA1200F	XXL Fixed Interface Arms	1200

\*VESA dimensions refer to the vertical fixings. Interface Arms can be horizontally positioned anywhere along the rail

### Step 6: (if required) Add Accessories

SHELVES AND ADAPTORS	
PRODUCT CODE	DESCRIPTION
BT8390-SA	Adjustable Mounting Arm
BT7863 <i>(pictured)</i>	Small AV Shelf
BT7032	Medium AV Shelf
BT7033	Large AV Shelf
BT7871 / BT7873 BT7874 / BT7875 / BT7877 BT7878 / BT7879	Video Bar Mounting Plate
BT7884	Flip-Down AV Storage Tray
BT7888	Fixed Storage Tray

## Step 1

Choose **Floor** Or **Wall Mounted** Setup

### Wall Mounts



BT8390-WFK1    BT8390-WFK2    BT8390-WFK5    BT8390-WFK6



BT8390-WFK3    BT8390-WFK8    BT8390-WFK4

### Floor Bases



BT8380-FFB    BT8380-AFB    BT8380-RFB



BT8380-BASE    BT8380-SHB    BT8380-FSB

### BT8380-Base Accessories

For use with BT8380-BASE only



BT8380-CASTORS

## Step 2

Choose Height Of Column

### Columns

BT8380-060 (0.6m)  
BT8380-180 (1.8m)



### Column Extension Kit

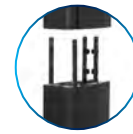

BT8380-EXTV

### Columns

#### Wall Tie-Back



BT8380-WTB

#### False Floor Trim



BT8380-FFT



BT8380-060 (0.6m)    BT8380-180 (1.8m)

# Create a custom System X wall mount or floor stand in 4 simple steps

The System X range offers a versatile, component-based design for multi-screen and digital signage applications. Components can be individually supplied for custom installations, providing flexibility and convenience. Additionally, System X is compatible with System 2 Ø50mm poles for ceiling-mounted set-ups. See the next page for more information.

## Step 3

Choose Length Of Mounting Rail

### Mounting Rails

- BT8390-050 (0.5m)
- BT8390-070 (0.7m)
- BT8390-100 (1m)
- BT8390-150 (1.5m)
- BT8390-175 (1.75m)
- BT8390-200 (2m)



### Rail Extension Kit



BT8390-EXT

### Angle Connector



BT8390-AAC

### Mounting Rails

- BT8390-050 (0.5m)
- BT8390-070 (0.7m)
- BT8390-100 (1m)
- BT8390-150 (1.5m)
- BT8390-175 (1.75m)
- BT8390-200 (2m)



### Joining Kit



BT8380-JPK

BT8380-JPT

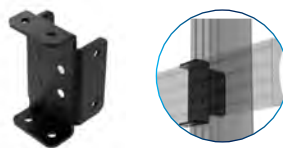

BT8380-JPR

### Adaptor Kit



For use with non-System X interfaces

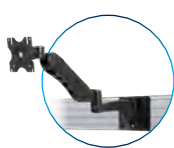

BT8390-ADP

## Step 4

Choose Screen Interface Kit

### Screen Interface Arms



BT8390-VESA200F

BT8390-VESA200T



BT8390-VESA400F

BT8390-VESA400T



BT8390-VESA400MAF

BT8390-VESA400MAP



BT8390-VESA600F

BT8390-VESA800F

BT8390-VESA1200F

### Step 5 Add Accessories



BT7884

BT8390-RCP



BT7032

BT7033



BT8390-SA

BT7863

BT7866

BT7871-79

## Step 1

Choose a **SYSTEM2** ceiling, wall or floor mount

### Ceiling Mounts



### Specialist Mounts



### Wall Mounts



### Floor Mounts



## Step 2

Choose length of **SYSTEM2** pole

### Ø50mm Poles

- Standard**
- BT7850-050 (0.5m)
  - BT7850-100 (1m)
  - BT7850-150 (1.5m)
  - BT7850-200 (2m)
  - BT7850-300 (3m)
- Heavy-Duty** *only available in black*
- BT7853-200 (2m)
  - BT7853-300 (3m)



### Pole Ring



BT7055

### Pole Joiners

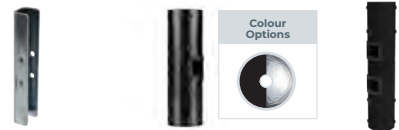

BT7823

BT7824

BT7852

### Ø50mm Poles

- Standard**
- BT7850-050 (0.5m)
  - BT7850-100 (1m)
  - BT7850-150 (1.5m)
  - BT7850-200 (2m)
  - BT7850-300 (3m)
- Heavy-Duty** *only available in black*
- BT7853-200 (2m)
  - BT7853-300 (3m)

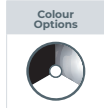

### Pole Ring



BT7055

# Create a custom System X ceiling mount in 4 simple steps

The System X range offers a versatile, component-based design for multi-screen and digital signage applications. Components can be individually supplied for custom installations, providing flexibility and convenience. Additionally, System X is compatible with System 2 Ø50mm poles for ceiling-mounted setups.

## Step 3

Choose length of SYSTEM X mounting rail

### Ø50mm Accessory Collars



BT7841

BT7052

BT7051

### Collar Mounting Bracket



BT8390-CFK

### Mounting Rails



- BT8390-050 (0.5m)
- BT8390-070 (0.7m)
- BT8390-100 (1m)
- BT8390-150 (1.5m)
- BT8390-175 (1.75m)
- BT8390-200 (2m)

### Rail Extension Kit



BT8390-EXT

### Angle Connector



BT8390-AAC

### Mounting Rails

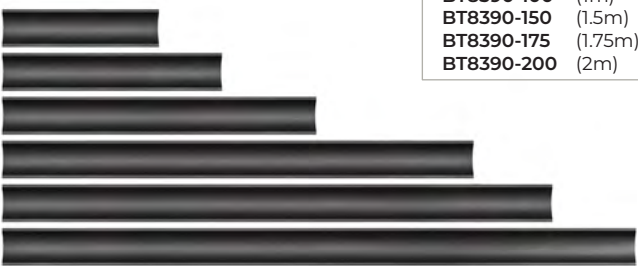

- BT8390-050 (0.5m)
- BT8390-070 (0.7m)
- BT8390-100 (1m)
- BT8390-150 (1.5m)
- BT8390-175 (1.75m)
- BT8390-200 (2m)

## Step 4

Choose a SYSTEM X interface kit and accessory

### Accessories



BT7032

BT7033

BT7865

### Accessory Arm



BT8390-SA

BT7863

BT7866

BT7871-BT7879

### Screen Interface Arms



BT8390-VESA200F

BT8390-VESA200T



BT8390-VESA400F

BT8390-VESA400T



BT8390-VESA400MAF

BT8390-VESA400MAP

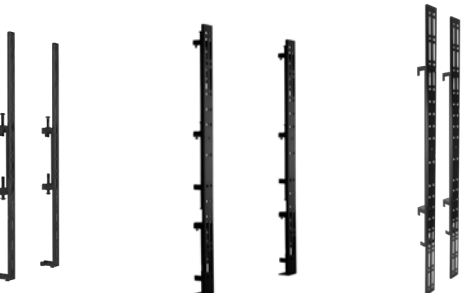

BT8390-VESA600F

BT8390-VESA800F

BT8390-VESA1200F

# System X: Mounting Rails & Wall Fixing Kits

## BT8390

### Horizontal Mounting Rail



Use System X Interface Arms and Fixing Kits to create a variety of mounting solutions

## BT8390-EXT

### Rail Extension Kit

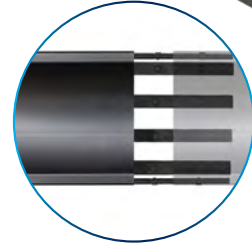

Combines BT8390 Rails



Available in 6 rail lengths\*

BT8390-050	0.5m Rail	BT8390-150	1.5m Rail
BT8390-070	0.7m Rail	BT8390-175	1.75m Rail
BT8390-100	1m Rail	BT8390-200	2m Rail

\*Rails can be cut to length on request or for increased length, rails can be combined using the BT8390-EXT

## System X: Rail Fixing Kits

### BT8390-WFK1

#### Rail Mounting Bracket



Fixes a BT8390 Rail to the wall

### BT8390-WFK2

#### Rail Mounting Bracket



Wall plate with added depth  
Ideal for use with System X interface arms with tilt

### BT8390-WFK3

#### Dual Rail Mounting Bracket



Mounts x2 BT8390 Rails  
Ideal for use with BT8390-VESA800F Interface Arms.  
Can also be used with BT8380 Columns

### BT8390-WFK5

#### Adjustable Depth Rail Mounting Bracket

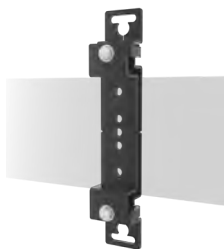

+/-5mm depth adjustment  
Ideal for uneven walls

### BT8390-WFK6

#### Adjustable Height & Depth Rail Mounting Bracket

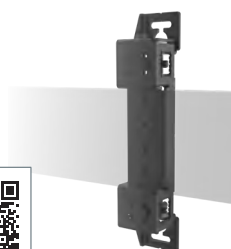

+/-10mm depth adjustment  
+/-10mm height adjustment  
Ensures a precise installation

### BT8390-WFK8

#### Ultra-Slim Rail Mounting Bracket

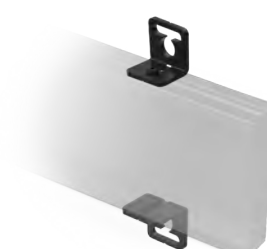

### BT8390-WFK4

#### Wall-To-Wall Rail Mounting Brackets

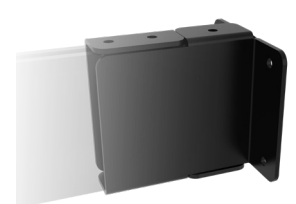

Ideal for mounting System X Rails between opposing walls

## BT8380 Vertical Column

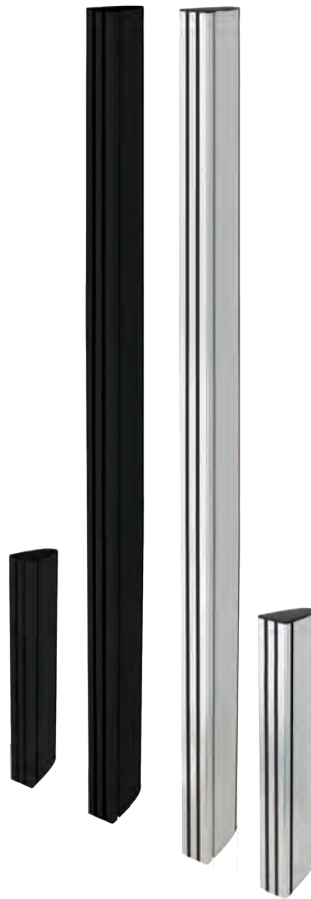

## BT8380-EXTV Column Extension Kit

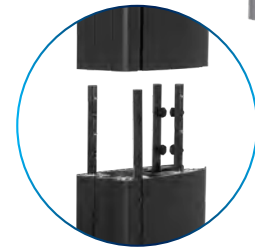

Combines  
BT8380  
Columns

\*For increased height, columns can be joined together using BT8380-EXTV



Available in 2 column heights\*

BT8380-060 0.6m Column

BT8380-180 1.8m Column

## System X: Rail Joining Kits

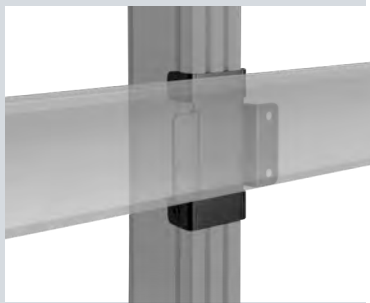

### BT8380-JPK Joining Plate Kit

Connects BT8390 Rails to BT8380 columns



### BT8380-JPT Joining Plate Tilt Adaptor

Attaches BT8390 rails to BT8380 columns

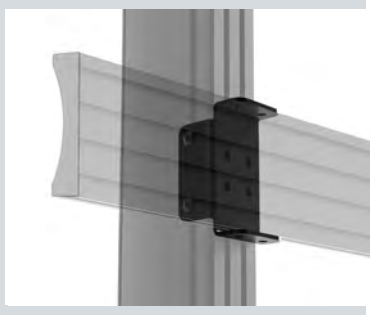
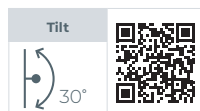

### BT8380-JPR Column Mounting Plate

For reverse mounting BT8390 rails to BT8380 columns





**BT8380-BASE**  
**Floor Base**  
 for Trolleys & Stands

Max Load  
 200kg



**BT8380-SHB**  
**Short Floor Base**  
 for Stands

Max Load  
 50kg



**BT8380-FSB**  
**Freestanding Floor Base**

Max Load  
 70kg



**BT8380-FFB**  
**Bolt-Down Floor Base**

Max Load  
 200kg



**BT8380-AFB**  
**Bolt-Down Floor Base**  
 with Adjustable Levelling Plate

Max Load  
 200kg

Height levelling -  
 Ideal for uneven surfaces

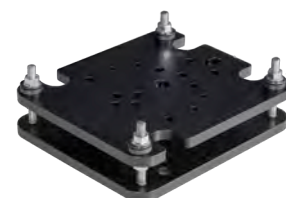

**BT8380-RFB**  
**Retractable Floor Base**

Max Load Column 150kg  
 Max Load Pole 40kg



## System X: Bases

Model	Mount	Dimensions	Max Load (Per Column)	Level Adjustment	Castor Compatible
BT8380-BASE	Freestanding	950 x 86mm	200kg	N/A	<input checked="" type="checkbox"/>
BT8380-SHB	Freestanding	600 x 86mm	50kg	N/A	N/A
BT8380-FSB	Freestanding	890 x 604mm	70kg	N/A	N/A
BT8380-FFB	Bolt-Down	240 x 240mm	200kg	N/A	N/A
BT8380-AFB	Bolt-Down	183 x 213mm	200kg	+/-13.5mm	N/A
BT8380-RFB	Bolt-Down	262 x 88 x 406-806mm	150kg	N/A	N/A

## ALSO AVAILABLE...

**BT8380-CASTORS**  
**4" Non-Marking Braked Castors**

Fits onto **BT8380-BASE**  
 (Supplied in pairs)







## BT8390-VESA200F

### Interface Arms

for Small / Medium Sized Screens



Max Load  70kg	Max VESA Vertical 200	
---	--------------------------	---



## BT8390-VESA200T

### Interface Arms with Tilt

for Small / Medium Sized Screens



Max Load  70kg	Max VESA Vertical 200	Tilt  20°	
---	--------------------------	--	---



## BT8390-VESA400F

### Interface Arms

for Medium / Large Sized Screens



Max Load  70kg	Max VESA Vertical 400	
---	--------------------------	---



## BT8390-VESA400T

### Interface Arms with Tilt

for Medium / Large Sized Screens



Max Load  70kg	Max VESA Vertical 400	Tilt  20°	
---	--------------------------	--	---



## BT8390-VESA400MAF

### Interface Arms with Micro-Adjustment

for Medium / Large Sized Screens

Max Load  50kg	Max VESA Vertical 400	
---	--------------------------	---



## BT8390-VESA400MAP

### Pop-Out Interface Arms with Micro-Adjustment

for Medium / Large Sized Screens

Max Load  50kg	Max VESA Vertical 400	
---	--------------------------	---



## BT8390-VESA600F Interface Arms for Large Screens

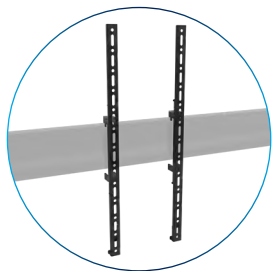

Max Load 70kg	Max VESA Vertical 600	
------------------	--------------------------	--

## BT8390-VESA800F Interface Arms for XL Screens

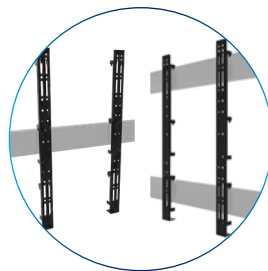

Mounts on 1 or 2  
BT8390 Rails

Max Load 1 Rail 70kg	Max Load 2 Rails 200kg	Max VESA Vertical 800	
----------------------------	------------------------------	--------------------------	--

## BT8390-VESA1200F Interface Arms for XXL Screens

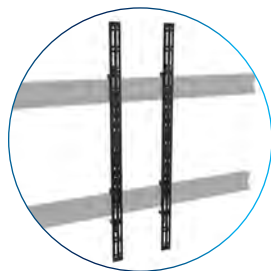

Mounts across 2 rails

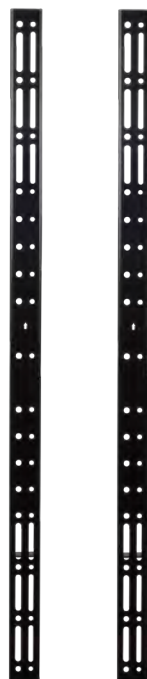

Max Load 2 Rails 200kg	Max VESA Vertical 1200	
------------------------------	---------------------------	--

## BT8390-SA Adjustable Accessory Mounting Arm

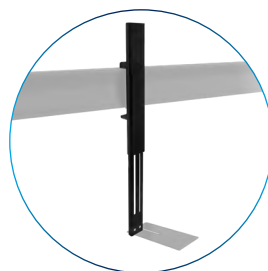

Adjustable mounting arm ideal for mounting shelves, VC cameras, video bars above or below the screen  
*see page 92*



### System X: Interface Arms

Model Number	Function	VESA*	Max Load	Micro-Adjustment
BT8390-VESA200F	Fixed	200	70kg	N/A
BT8390-VESA200T	Tilt	200	70kg	N/A
BT8390-VESA400F	Fixed	400	70kg	N/A
BT8390-VESA400T	Tilt	400	70kg	N/A
BT8390-VESA400MAF	Fixed, Micro-Adjustment	400	50kg	Depth: +/-10mm Height: +/-25mm
BT8390-VESA400MAP	Pop-Out, Micro-Adjustment	400	50kg	Depth: +/-10mm Height: +/-20mm
BT8390-VESA600F	Fixed	600	70kg	N/A
BT8390-VESA800F	Fixed	800	70kg / 200kg	N/A
BT8390-VESA1200F	Fixed	1200	200kg	N/A

\*Refers to vertical VESA fixings only



## BT8390-CFK Collar Mounting Bracket

Attaches BT8390 rails to System 2  
Ø50mm poles using collars

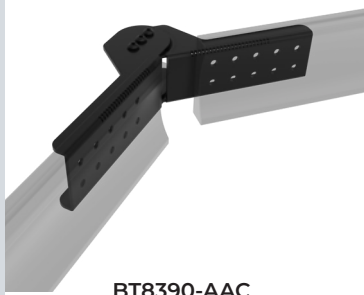

## BT8390-AAC Angle Adjustment Connector

**BT8390-AAC**  
Create curved installations



Rail angle adjustment range: +/- 45°

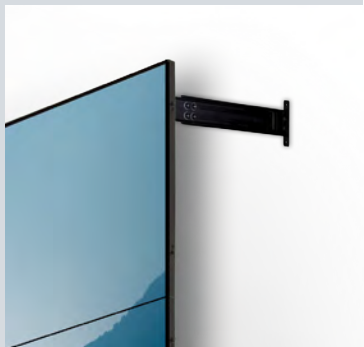

## BT8380-WTB Wall Tie-Back

Secures System X stands to  
adjacent walls



Adjustable arm extension: 214mm -707mm



**BT8390-CMC**  
Keep cables tidy and secure  
along BT8390 rails



## BT8390-CMC Cable Management Clips



Supplied in packs of 3

## BT8380-FFT False Floor Trim



Split design ideal for retro fitting on installations

Custom covers for all  
screen sizes



## BT8390-RCL Rear Covers for Landscape Displays



## BT8390-RCP Rear Covers for Portrait Displays



## Ø50mm Pole Mounted Component Range



The System 2 Range is a component system that works on a modular principle based around the use of Ø50mm (2") poles, which can easily be cut to length and joined.

With various mounting options, poles can be attached to the wall, ceiling or System X bases and can hold all AV devices by clamping them to the poles using Ø50mm accessory collars. Specialist mounts for joists, purlins, I-beams and internal and external pole joiners make the System 2 Range a truly versatile and flexible modular mounting system that allows AV equipment to be mounted almost anywhere.

For complete product specifications, including technical drawings and colour options, scan the QR code for each product to view the online page.



**Ø50mm Pole Components**



**Pole Mounts for the Ceiling, Wall and Floor**



**Combine System 2 & System X Components**



# System 2: Quick-Start Guides

## SYSTEM 2™

### Quick-Start Guide: Flat Screen Ceiling Mounts *Basic Installation*

This quick start guide demonstrates the steps to create a basic flat-screen ceiling installation using the System 2 range. Follow the listed steps to create the ideal bespoke installation for your mounting needs.

for more information or to see how the range can be used in alternative installations, please get in touch with us at [technical@btechavmounts.com](mailto:technical@btechavmounts.com)

### Step 1:

Choose a Ceiling Mount

#### WALL FIXING KITS

PRODUCT CODE	DESCRIPTION
BT7807	Heavy Duty Twin Pole Floor / Ceiling Mount
BT7808	Ceiling / Wall Mount with Tilt
BT7822 <i>(pictured)</i>	Heavy Duty Floor / Ceiling Mount
BT7851*	Telescopic Ceiling Mount

#### SPECIALIST MOUNTS

BT7012	Purlin Mount
BT7017	I-Beam (Girder) Mount
BT7825	Truss Clamp
BT7831	Wall Mounting Bracket

\***BT7851 Telescopic Ceiling Mount** does not require an additional pole - go straight to Step 3

### Step 2:

Choose a Ø50mm Pole

#### POLES

PRODUCT CODE	LENGTH*
BT7850-050	0.5m
BT7850-100	1m
BT7850-150 <i>(pictured)</i>	1.5m
BT7850-200 <i>(pictured)</i>	2m
BT7850-300	3m

\*To extend poles, choose a joiner listed below and an additional pole to fit to.

#### POLE JOINERS

PRODUCT CODE	DESCRIPTION
BT7823 <i>(pictured)</i>	Internal Pole Joiner
BT7824	External Pole Joiner



### Step 3:

Choose a Screen Mount

#### FLAT SCREEN MOUNTS

PRODUCT CODE	DESCRIPTION	MAX VESA*	COLLARS REQ.
BT7510	Fixed Mount	100	1
BT7511 <i>(pictured)</i>	Mount with Tilt	100	1
BT7518	Mount with Tilt & Swivel	100	2
BT7551	Pole Mount	100	0
BT7523	Mount with Tilt	200	1
BT8431	Mount with Tilt	400	2
BT8441	Fixed Mount	400	2
BT8432	Mount with Tilt	600 400	2
BT9903	Fixed Mount	1000 600	4 <i>(twin poles only)</i>
BT9910	Mount with Tilt	1000 600	4 <i>(twin poles only)</i>

### Step 4: (if required)

Choose a Collar

#### COLLARS

PRODUCT CODE	DESCRIPTION
BT7051	Heavy-Duty Accessory Collar
BT7052	Accessory Collar
BT7841 <i>(pictured)</i>	2-Piece Accessory Collar

Please note some screen mounts do not require an accessory collar, please see **Step 3** for collar requirements

## SYSTEM 2™

### Quick-Start Guide: Projector Mounts *Basic Installation*

This quick start guide demonstrates creating a basic projector ceiling mount using the System 2 range. Follow the listed steps to create the ideal bespoke installation for your mounting needs.

for more information or to see how the range can be used in alternative installations, please get in touch with us at [technical@btechavmounts.com](mailto:technical@btechavmounts.com)

### Step 1:

Choose a Ceiling Mount

#### WALL FIXING KITS

PRODUCT CODE	DESCRIPTION
BT7807	Heavy Duty Twin Pole Floor / Ceiling Mount
BT7808	Ceiling / Wall Mount with Tilt
BT7822	Heavy Duty Floor / Ceiling Mount
BT7851* <i>(pictured)</i>	Telescopic Ceiling Mount

#### SPECIALIST MOUNTS

BT7012	Purlin Mount
BT7017	I-Beam (Girder) Mount
BT7825	Truss Clamp
BT7831	Wall Mounting Bracket

\*BT7851 Telescopic Ceiling Mount does not require an additional pole - go straight to Step 3

### Step 2:

Choose a Ø50mm Pole

#### POLES

PRODUCT CODE	LENGTH*
BT7850-050	0.5m
BT7850-100	1m
BT7850-150 <i>(pictured)</i>	1.5m
BT7850-200 <i>(pictured)</i>	2m
BT7850-300	3m

\*To extend poles, choose a joiner listed below and an additional pole to fit to.

#### POLE JOINERS

PRODUCT CODE	DESCRIPTION
BT7823 <i>(pictured)</i>	Internal Pole Joiner
BT7824	External Pole Joiner

### Step 3:

Choose a Projector Mount

#### COLLARS

PRODUCT CODE	DESCRIPTION
BT899	Projector Mount
BT899XL <i>(pictured)</i>	Extra-Large Projector Mount
BT893	Heavy-Duty Projector Mount



# System 2: Quick-Start Guides

## SYSTEM 2™

### Quick-Start Guide: Flat Screen Ceiling Mounts *Intermediate Installation*

This quick start guide demonstrates how to create a CCTV installation using the System 2 range. Follow the listed steps to create the ideal bespoke installation for your mounting needs. Start with the basics and add additional devices, such as screens or accessories, as desired

for more information or to see how the range can be used in alternative installations, please get in touch with us at [technical@btechavmounts.com](mailto:technical@btechavmounts.com)

### Step 1:

#### Choose a Ceiling Mount

##### WALL FIXING KITS

PRODUCT CODE	DESCRIPTION
BT7807	Heavy Duty Twin Pole Floor / Ceiling Mount
BT7808 <i>(pictured)</i>	Ceiling / Wall Mount with Tilt
BT7822	Heavy Duty Floor / Ceiling Mount
BT7851*	Telescopic Ceiling Mount

##### SPECIALIST MOUNTS

BT7012	Purlin Mount
BT7017	I-Beam (Girder) Mount
BT7825	Truss Clamp
BT7831	Wall Mounting Bracket

\*BT7851 Telescopic Ceiling Mount does not require an additional pole - go straight to Step 3

### Step 2:

#### Choose a Ø50mm Pole

##### POLES

PRODUCT CODE	LENGTH*
BT7850-050	0.5m
BT7850-100 <i>(pictured)</i>	1m
BT7850-150	1.5m
BT7850-200	2m
BT7850-300	3m

\*To extend poles, choose a joiner listed below and an additional pole to fit to.

##### POLE JOINERS

PRODUCT CODE	DESCRIPTION
BT7823 <i>(pictured)</i>	Internal Pole Joiner
BT7824	External Pole Joiner

### Step 3:

#### Choose a CCTV Mount\*

##### DOME CAMERA MOUNT

PRODUCT CODE	DESCRIPTION
BT6010 <i>(pictured)</i>	Security Dome Camera Mount

\*For more CCTV mounting solutions refer to the System V range on from page 140



### Step 4: (optional)

#### Choose a Screen Mount

##### FLAT SCREEN MOUNTS

PRODUCT CODE	DESCRIPTION	MAX VESA	COLLARS REQ.
BT7510	Fixed Mount	100	1
BT7511 <i>(pictured)</i>	Mount with Tilt	100	1
BT7518	Mount with Tilt and Swivel	100	2
BT7532	Fixed Mount	200	1
BT7523	Mount with Tilt	200	1
BT8431	Mount with Tilt	400	2
BT8441	Fixed Mount	400	2
BT8432	Mount with Tilt	600 x 400	2
BT8442	Fixed Mount	600 x 400	2

### Step 5: (if required)

#### Choose a Collar

##### COLLARS

PRODUCT CODE	DESCRIPTION
BT7051	Heavy-Duty Accessory Collar
BT7052	Accessory Collar
BT7841 <i>(pictured)</i>	2-Piece Accessory Collar



## SYSTEM 2™

### Quick-Start Guide: Floor-to-Ceiling Media Setup *Advanced Installation*

This quick start guide demonstrates the steps to create an advanced floor-to-ceiling installation using the System 2 range. Customise your installation as desired with an almost endless amount of screens and accessories using our diverse range of System 2 compatible mounts.

for more information or to see how the range can be used in alternative installations, please get in touch with us a [technical@btechavmounts.com](mailto:technical@btechavmounts.com)

### Step 1:

Choose a Ceiling Mount

#### WALL FIXING KITS

PRODUCT CODE	DESCRIPTION
BT7807	Heavy Duty Twin Pole Floor / Ceiling Mount
BT7808	Ceiling / Wall Mount with Tilt
BT7822 <i>(pictured)</i>	Heavy Duty Floor / Ceiling Mount
BT7851*	Telescopic Ceiling Mount

#### SPECIALIST MOUNTS

BT7012	Purlin Mount
BT7017	I-Beam (Girder) Mount
BT7825	Truss Clamp
BT7831	Wall Mounting Bracket

\*BT7851 Telescopic Ceiling Mount does not require an additional pole - go straight to Step 3

### Step 2:

Choose a Ø50mm Pole

#### POLES

PRODUCT CODE	LENGTH*
BT7850-050	0.5m
BT7850-100 <i>(pictured)</i>	1m
BT7850-150	1.5m
BT7850-200	2m
BT7850-300	3m

\*To extend poles, choose a joiner listed below and an additional pole to fit to.

#### POLE JOINERS

PRODUCT CODE	DESCRIPTION
BT7823 <i>(pictured)</i>	Internal Pole Joiner
BT7824	External Pole Joiner

### Step 3:

Choose a Floor Fixing

#### FLOOR FIXINGS

PRODUCT CODE	DESCRIPTION
BT7056	Floor Fixing Kit
BT7807	Heavy-Duty Twin Pole Floor / Ceiling Mount
BT7822	Heavy-Duty Single Pole Floor / Ceiling Mount



### Step 4:

Choose a Screen Mount

#### FLAT SCREEN MOUNTS

PRODUCT CODE	DESCRIPTION	MAX VESA	COLLARS REQ.
BT7510	Fixed Mount	100	1
BT7511	Mount with Tilt	100	1
BT7518	Mount with Tilt and Swivel	100	2
BT7551	Pole Mount	100	0
BT7532	Fixed Mount	200	1
BT7523 <i>(pictured)</i>	Mount with Tilt	200	1
BT8431	Mount with Tilt	400	2
BT8441	Fixed Mount	400	2
BT8432	Mount with Tilt	600 400	2
BT9903	Fixed Mount	1000 600	4 <i>(twin poles only)</i>
BT9910	Mount with Tilt	1000 600	4 <i>(twin poles only)</i>

### Step 5: (if required)

Choose a Collar

#### COLLARS

PRODUCT CODE	DESCRIPTION
BT7051	Heavy-Duty Accessory Collar
BT7052	Accessory Collar
BT7841 <i>(pictured)</i>	2-Piece Accessory Collar

Please note some screen mounts do not require an accessory collar, please see Step 3 for collar requirements

### Step 6: (optional)

Add Accessories

#### SHELVES AND ADAPTORS

PRODUCT CODE	DESCRIPTION	COLLARS REQ.
BT7033	300 x 300mm AV Shelf	1 or 2*
BT7032	500 x 380mm AV Shelf	1 or 2*
BT7880	Apple® TV Mount	1
BT7863	VC Camera Shelf	1
BT7871 / BT7873 BT7874 / BT7875 / BT7877 BT7878 / BT7879	Video Bar Mounting Plates	1
BT7864	Twin-Pole VC Camera Shelf	2
BT7865	Keyboard and Mouse Shelf	2*

\*BT7032 / BT7033 / BT7865 can be mounted on single or twin poles

## Step 1

Choose a pole mount

### Ceiling Mounts



### Specialist Mounts



### Wall Mounts



### Floor Mounts



## Step 2

Choose a pole

### Ø50mm Poles

**Standard**  
 BT7850-050 (0.5m)  
 BT7850-100 (1m)  
 BT7850-150 (1.5m)  
 BT7850-200 (2m)  
 BT7850-300 (3m)

**Heavy-Duty** *only available in black*  
 BT7853-200 (2m)  
 BT7853-300 (3m)



### Pole Joiners



### Finishing Ring



### Ø50mm Accessory Collars



### Swivel Pole Adaptor



### Swivel Pole Adaptor



### Collar Kit



### System X Mounting Rails & Components

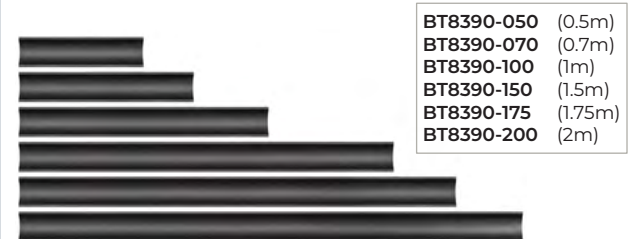

Choose suitable System X screen interface arms to use with mounting rails

# Create a custom pole mounted solution in 4 simple steps

The System 2 range is a component-based mounting system designed around the use of Ø50mm poles. For flexibility and convenience, components are supplied individually and can be used to create custom installations to suit any application. System 2 is also compatible with the System X range for ceiling-mounted videowall applications.

## Step 3

Choose a collar or mount

### Ø50mm Double Collar



BT7051

### Ø50mm Single Collars



BT7052

BT7841

### Column / Pillar Clamp



BT7832

### Flat Screen Pole Interface



BT7551

### Security Camera Mount



BT6010

### Projector Mounts



BT893



BT899XL

BT899

## Step 4

Choose screen interface kit and/or accessory

### Twin Pole Flat Screen Mount

4 Collars Required



BT9901

BT9903

BT9910

### Adaptors



BT7502

BT7542

BT7540



BT7564



BT7565

### Flat Screen Mounts

1 Collar Required



BT7510



BT7511



BT7523

2 Collars Required



BT7518



BT7532

2 Collars Required (Single Pole), 4 Collars Required (Double Pole)



BT7550



BT8441



BT8431



BT8442



BT8432

### Full Service Flat Screen Mounts

2 Collars Required



BT8309

4 Collars Required



BT8312



BT8310XL

### Shelf Adaptor



BT7031

### Shelves and Accessory Mounts

1 Collar Required



BT7033



BT7863



BT7866



BT7871 / BT7873 / BT7874 / BT7875 / BT7878 / BT7879

2 Collars Required



BT7032



BT7865



BT77

2 Collars Required



BT7862



BT7864

# System 2: Poles

## BT7850

Ø50mm Pole

5 Pole Lengths Available\*

BT7850-050	0.5m Pole
BT7850-100	1m Pole
BT7850-150	1.5m Pole
BT7850-200	2m Pole
BT7850-300	3m Pole



BT7850 pole colour options: Black, Chrome or White (0.5m, 1m 1.5m)

\*Poles can be joined together using a pole joiner or cut down to size upon request

## BT7853

Heavy Duty Ø50mm Pole

2 Pole Lengths Available\*

BT7853-200	2m Pole
BT7853-300	3m Pole



## System 2: Pole Joiners



No visible join using internal joiners



Features cable management hole

### BT7823

Internal Pole Joiner  
for Ø50mm Poles



\*Not suitable for use with BT7853 Heavy Duty Poles



### BT7824

External Pole Joiner  
for Ø50mm Poles





Can also be used as a bolt-down floor mount for Floor-to-Ceiling installations

**BT7822**  
**Heavy Duty Ceiling / Floor Mount**  
 for Ø50mm Poles

Max Load	



Can also be used as a bolt-down floor mount for Floor-to-Ceiling installations

**BT7807**  
**Heavy Duty Twin Pole Ceiling / Floor Mount**  
 for Ø50mm Poles

Max Load	

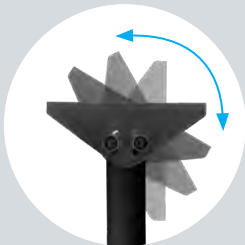

Up to +90° tilt of pole  
 Ideal for angled ceilings or walls

**BT7808**  
**Ceiling / Wall Mount With Tilt**  
 for Ø50mm Poles

Max Load	Tilt	



Tool-less adjustment of ceiling drop  
 In 25mm increments

**BT7851**  
**Adjustable Drop Ceiling Mount**  
 for Ø50mm Poles

Max Load	



# System 2: Specialist Pole Mounts



Fits 'C' and 'Z' section purlin with a minimum height of 95mm

**BT7012**  
Purlin Mount  
for Ø50mm Poles

Max Load	Tilt	
140kg	45°	



Adjustable clamp width  
80mm -250mm

**BT7017**  
I-Beam / Girder Mount  
for Ø50mm Poles

Max Load	Tilt	
140kg	36°	



Truss compatibility:  
Ø42mm - Ø50mm

**BT7825**  
Truss Mount  
for Ø50mm Poles

Max Load Single Screen	Max Load Back-to-Back	
70kg	140kg	



Ideal for floor-to-wall or  
Ceiling-to-wall installations

**BT7831**  
Wall Mounting Bracket  
for Ø50mm Poles

Max Load	
150kg	



## System 2: Ceiling Mounts

	BT7822	BT7807	BT7808	BT7851	BT7012	BT7017	BT7825	BT7831
<b>Max load</b>	150kg	200kg	140kg	100kg	140kg	140kg	70kg	150kg
<b>Tilt</b>	N/A	N/A	+90°	N/A	+45°	+/-36°	N/A	N/A
<b>Ceiling</b>	<input checked="" type="checkbox"/>	<input checked="" type="checkbox"/>	<input checked="" type="checkbox"/>	<input checked="" type="checkbox"/>	<input checked="" type="checkbox"/>	<input checked="" type="checkbox"/>	<input checked="" type="checkbox"/>	N/A
<b>Floor</b>	<input checked="" type="checkbox"/>	<input checked="" type="checkbox"/>	N/A	N/A	N/A	N/A	N/A	N/A
<b>Wall</b>	N/A	N/A	<input checked="" type="checkbox"/>	N/A	N/A	N/A	N/A	<input checked="" type="checkbox"/>
<b>Specs</b>	Plate Dims: Ø150mm	Plate Dims: 426 x 150mm	Plate Dims: 200 x 71mm	Ceiling Drop: 600-1000mm	Fits Purlins: 'C' & 'Z' sections	Clamp Width: 80mm - 250mm	Truss compatibility: Ø42 - Ø50mm	Distance from Wall 145mm
<b>Colour options</b>	<input checked="" type="checkbox"/>	<input checked="" type="checkbox"/>	<input checked="" type="checkbox"/>	<input checked="" type="checkbox"/>	N/A	N/A	N/A	N/A



Fixes onto the back of a B-Tech flat screen mount or AV accessory

**BT7052**  
Ø50mm Accessory Collar



Ideal for retro-fitting AV Accessories onto System 2 Ø50mm poles

**BT7841**  
Ø50mm 2-Piece Accessory Collar



Use collars to pole mount System X rails

**BT7051**  
Ø50mm Heavy Duty Accessory Collar



Adds swivel to the attached bottom pole

**BT7852**  
Swivel Adaptor for Ø50mm Poles

Max Load	Swivel	
70kg	360°	





**BT7056**  
Floor Fixing Kit  
for Ø50mm Poles

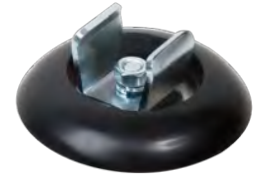

**BT7055**  
Ceiling Finishing Ring  
for Ø50mm Poles



**BT7832**  
Column / Pillar Clamp

Use with a collar compatible screen mount



Suitable for vertical columns  
with circumferences between  
140mm - 750mm  
*No drilling required*

## System 2: Flat Screen Mount

The following AV mounts attach directly to the bottom of System 2 BT7850 Poles

**BT7551**  
Flat Screen Ceiling/Desk Mount with Tilt & Swivel  
for Ø50mm Poles



Suitable for ceiling or  
floor mounting

Recommended Max Screen	Max Load	Max VESA	Tilt	Swivel	Rotation	QR Code
32" 81cm	23kg	100	15° 90°	360°	360°	





Attaches to the bottom of BT7850 Poles



Suitable for dome cameras with fixings between 63.5mm -103.5mm

## BT6010 Security Dome Camera Mount for Ø50mm Poles



Suitable for projectors with fixings up to 370mm

## BT899 Projector Mount with Micro-Adjustment



Suitable for projectors with fixings up to 493.5mm

## BT899XL XL Projector Mount with Micro-Adjustment

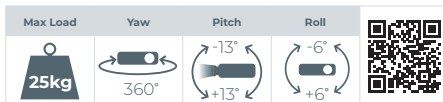

Suitable for XL projectors with fixings up to 873mm

## BT893 Heavy Duty Projector Mount with Micro-Adjustment



# Floor Stand Components



**Provided as individual components, floor stands can be designed and assembled to precisely meet your specific installation needs.**

B-Tech floor stands offer versatility with options for either Ø50mm floor poles or stylish aluminium columns designed to accommodate displays up to 75". The slim, low-profile bases are equipped with non-marking rubber feet, convenient grab handles for easy handling, and a cover plate for enhanced aesthetics. Mount your screen at any height along the pole or column, and B-Tech accessories such as AV shelves and video bar mounting plates can be seamlessly attached to the uprights.

To custom-build a floor stand, start by selecting a suitable base based on the screen and installation location. Then, add a pole (available in three heights) or a 1.8m column (offered in three colours). Choose an appropriate screen interface from B-Tech's wide range of flat-screen mounts. Finally, include component shelves or other accessories as needed. A joining plate is also available for those looking to integrate System X mounting rails and interface arms onto the stand.

For complete product specifications, including technical drawings and colour options, scan the QR code for each product to view the online page.

## Key Features

- Low-profile floor bases designed for use with single or twin B-Tech floor stand poles or BT8381 columns
- Screen interface kits and accessories are all available separately
- Compatible with B-Tech's System X and System 2 ranges to create a variety of flat-screen floor stands
- Heavy-duty bases made from 6mm thick steel construction
- Non-marking rubber feet
- Grab handles allow for easy handling
- Cover plate hides grab handles for a tidy finish
- Accessorise stands with AV shelves and video bar mounts
- Integrated cable management for a tidy finish



### Landscape and Portrait Mounting



### Accessorise with AV Components



### Twin Screen Mounting



## Step 1

Choose A Base

### Base Covers for Poles



BT4002-SPC

BT4002-TPC

### Freestanding Bases



BT4000



BT4001



BT4002

### Base Covers for Columns



BT4002-SCC

BT4002-TCC

### Fixed Floor Bases



BT8380-AFB

BT8381-FFB

BT8380-RFB

## Step 2

Choose A Pole

### Ø50mm Poles

BT4107 (0.75m)  
BT4116 (1.6m)  
BT4118 (1.8m)



BT4107

BT4116

BT4118

### Columns



BT8381 (1.8m)

Colour Options



## Step 3

Choose An Adaptor

### Tilt Adaptor



BT7027

### Collar



BT7052



BT7841

### Sliding Nuts



BT6174

### Joining Kit



BT8381-JPS

# Create a custom floor stand in 4 simple steps

B-Tech's flat screen floor stand and trolley components are available individually and can be used to create custom installations to suit any application.

View the complete range online...



## Step 4

Choose A Screen Mount

### Standard Screen Mounts



BT7510



BT7511



BT7518



BT7523



BT7532



BT8441



BT8431



BT7550



BT8442



BT8432

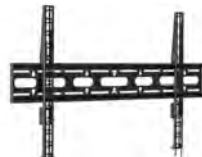

BT9903

### Shelves and Video Bar Mounts



BT7871 - BT7878



BT7866



BT7863



BT7032



BT7033



BT7865

### Shelf Arm



BT8390-SA

### Mounting Rails



BT8390

- BT8390-050 (0.5m)
- BT8390-070 (0.7m)
- BT8390-100 (1m)
- BT8390-150 (1.5m)

## Complete Floor Stand Solutions

### Pole Solutions



BT8570



BT8571



BT8572

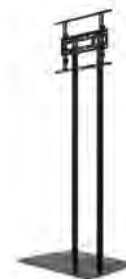

BT8573

### Column Solutions



BT8581



BT8582



BT8583

### Screen Enclosures



BT7901



BT8390-RCP

### Screen Interface Arms

BT8390-VESA200F

BT8390-VESA400F



BT8390-VESA200T



BT8390-VESA400T



BT8390-VESA400MAF

BT8390-VESA600F

BT8390-VESA1200F



BT8390-VESA400MAP



BT8390-VESA800F

## BT4000

### Small Floor Base

for use with a Ø50mm Floor Stand Pole



Max load when used with a BT4116 pole

## BT4001

### Medium Floor Base

for use with a BT8381 Column or a Ø50mm Floor Stand Pole



## BT4002

### Large Floor Base

for use with BT8381 Columns or a Ø50mm Floor Stand Poles

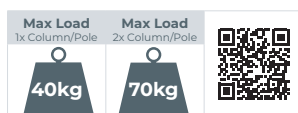

with a single column or pole

with twin columns or poles

## Cover Plates

for use with BT4000 / BT4001 / BT4002 Bases

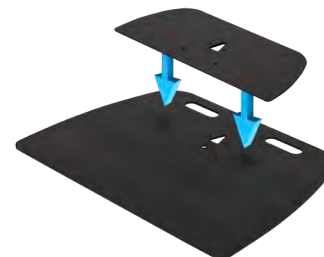

- Hides unused fixing holes and handles
- Order according to your preference for poles or columns and whether it is a single or double installation
- **BT4002-SPC** for use when installing a single pole to a base
- **BT4002-SCC** for use when installing a single column to a base
- **BT4002-TPC** for use when installing twin poles to a base
- **BT4002-TCC** for use when installing twin columns to a base
- Designed for use with B-Tech's BT4000\*, BT4001 and BT4002 bases
- Supplied with double sided adhesive tape to fix the cover plates

### Choose the cover plate to suit your installation

Floor Base	What verticals are you fitting to the base?			
	Single Pole	Single Column	Twin Poles	Twin Columns
<b>BT4000</b>	BT4002-SPC	X	X	X
<b>BT4001</b>	BT4002-SPC	BT4002-SCC	X	X
<b>BT4002</b>	BT4002-SPC	BT4002-SCC	BT4002-TPC	BT4002-TCC

## BT8381-FFB

### Fixed Floor Base

for use with a BT8381 Column

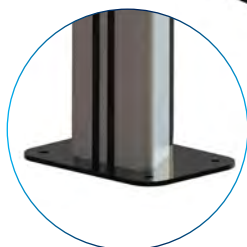

## Floor Bases

Model Number	Mounting	Max Load	Dimensions	No. Poles	No. Columns
<b>BT4000</b>	Freestanding	8kg	W.580mm x D.400mm	1	N/A
<b>BT4001</b>	Freestanding	35kg	W.700mm x D.515mm	1	1
<b>BT4002</b>	Freestanding	70kg	W.800mm x D.600mm	1 or 2	1 or 2
<b>BT8381-FFB</b>	Bolt-Down	50kg	W.220mm x D.160mm	N/A	1

## Ø50mm Floor Stand Poles



**BT4107** (0.75m)



**BT4116** (1.6m)



**BT4118** (1.8m)

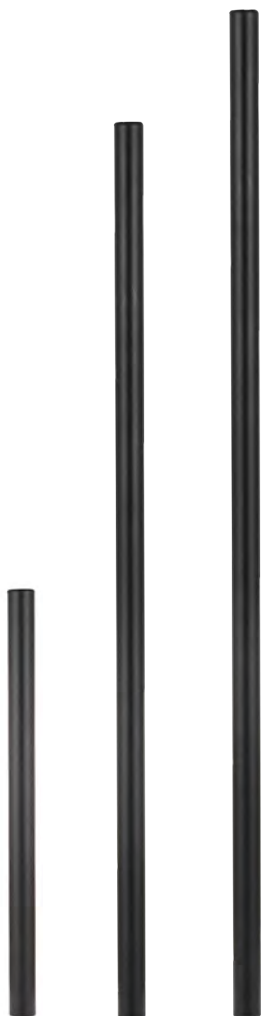
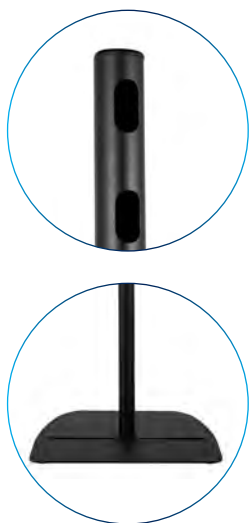

## BT8381

Vertical Support Column (1.8m)

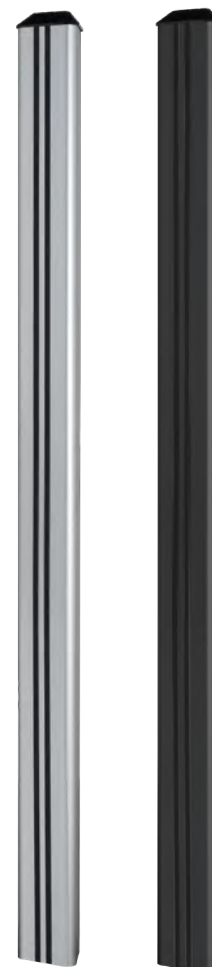

## Mounting Accessories

**BT7052**  
Ø50mm Accessory Collar



**BT7841**  
Ø50mm 2-Piece  
Accessory Collar



Collars attach B-Tech Mounts to Poles (BT4107 / BT4116 / BT4118)

**BT7027**  
Tilting Adaptor Plate  
for Ø50mm Poles



Ideal for low level stands

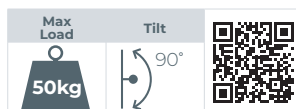

**BT8381-JPS**  
Rail-To-Column  
Joining Plate



Attaches a BT8390 Rail to a BT8381 Column

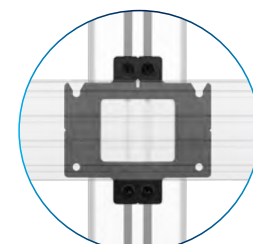

# SYSTEM V™

## Ø38mm Components & Ceiling Mounts for Security Systems



The System V Range of mounting solutions is a specialist range of products designed to install security cameras and CCTV systems into public spaces such as retail, transportation, corporate, government and leisure environments.

**System V** is a collection of mounting components designed around the use of Ø38mm poles, available in three lengths (*that can also be joined together using a pole joiner*) to install dome cameras and flat screens from the ceiling. The components encompass ceiling mounts, poles, a collar for affixing screen mounts, camera mounting plates catering to small to large dome cameras, and a 1.5" threaded adaptor compatible with equipment adhering to the NPT standard. Additionally, an adaptor is available to incorporate ceiling mounts from B-Tech's versatile System 2 range, facilitating CCTV installations that necessitate specialised mounts for I-Beams, Purlins, and Truss systems.

For convenience complete mounting solutions are also available to order - *See page 158.*





**Mount CCTV  
Dome Cameras**



**Use Collars to attach  
Flat Screen Mounts**



**Build to your  
requirements**



## Step 1

Choose A Pole Mount

### Ceiling Mounts



BT5925



BT5920



BT5921



BT5922

### Ceiling Mount Adaptor



BT5950

**SYSTEM 2™**

BT7825

Truss Clamp



BT7012

Purlin Mount



## Step 2

Choose A Pole

### Ø38mm Poles



### Finishing Ring



BT5953

BT5935-100 (1m)

BT5935-200 (2m)

BT5935-300 (3m)

### Pole Joiners

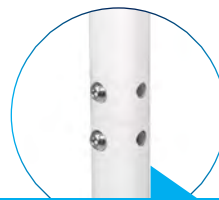

Join x2 **BT5935**  
Ø38mm Poles to  
extend the drop of  
System V installations



BT5923

# Create a custom pole mounted solution in 4 simple steps

The **System V** range is a component based system based around the use of Ø38mm poles. For greater flexibility and convenience, components are supplied individually and can be used to create custom installations to suit any application.

## Step 3

Choose A Collar Or Mount

### Ø38mm Collar

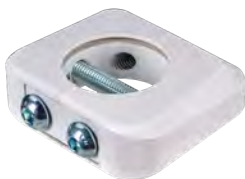

BT5952

### Security Camera Mounts



BT5909



BT5910



BT5911

### NPT Adaptor



Attaches a NPT 1.5" Security Camera to a System V Pole

BT5951

## Step 4

Choose Screen Interface Kit

### Flat Screen Mounts



BT7510



BT7511



BT7523



BT7518



BT7532

## Complete Kits

Off-The-Shelf Kits

### Flat Screen Mounts

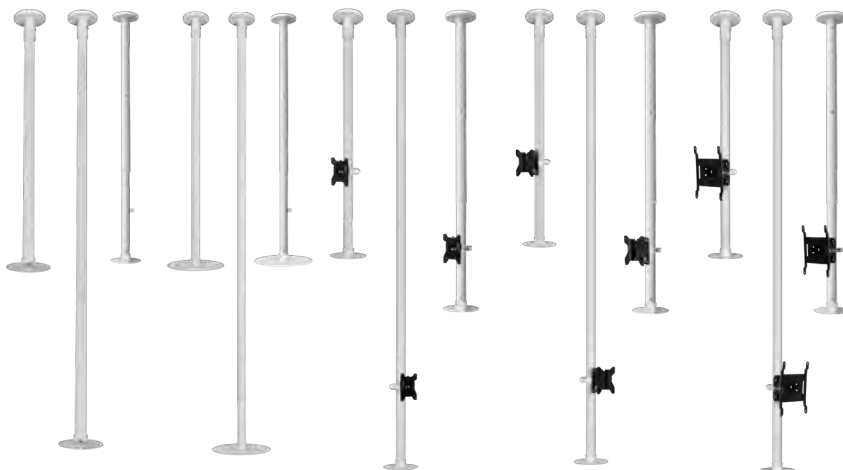

BT5960

BT5961

BT5962

BT5963

BT5964

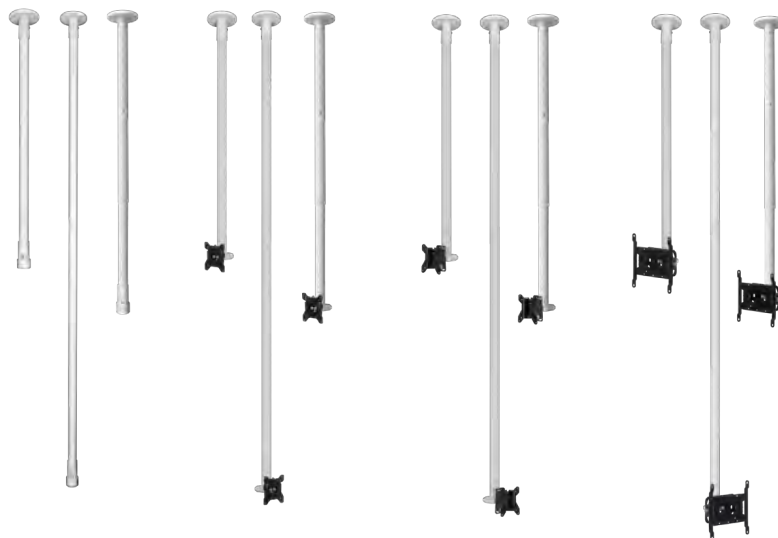

BT5965

BT5970

BT5971

BT5972

- BT5920**  
Fixed Ceiling Mount  
for use with **BT5935** Ø38mm Poles



Max Load  
**75kg**

- BT5921**  
Ceiling Mount with Tilt  
Tilt suitable for mounting on angled ceilings or walls



Max Load  
**75kg**

Tilt  
90°

- BT5922**  
Girder / Purlin Mount



Max Load  
**70kg**

Tilt  
90°

Adjustable clamp suitable for:  
I-beams (w: 65 - 267mm)  
C-section, Z section,  
Sigma-section Purlins (w: 50 - 230.5mm)

- BT5925**  
Adjustable Drop Ceiling Mount



Max Load  
**25kg**

- BT5935**  
Ø38mm Pole

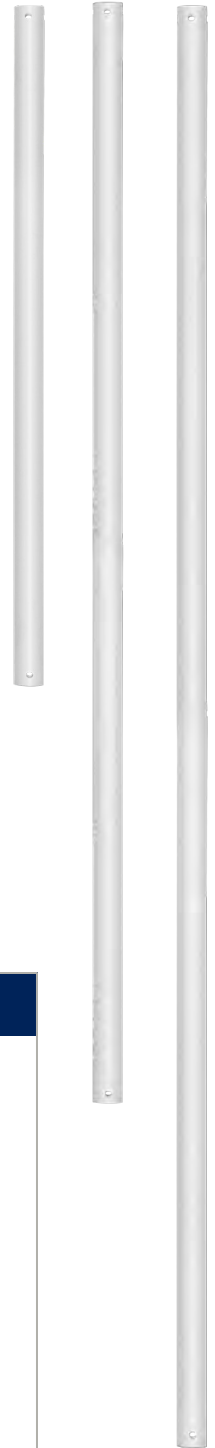
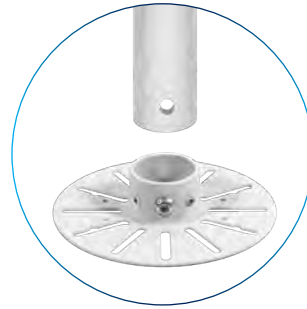

Fits easily to other **System V**  
Components such as **BT5920** Ceiling  
Mount and **BT5910** Camera Mount

Available in 3 pole lengths

<b>BT5935-100</b>	1m Pole
<b>BT5935-200</b>	2m Pole
<b>BT5935-300</b>	3m Pole



## System V: Pole Joiner

Join x2 **BT5935** Ø38mm Poles to extend the drop of a **System V** installation

- BT5923**  
Internal Pole Joiner  
for use with **BT5935**  
Ø38mm Poles



## System V: Ceiling Mounts

Model Number	Total Max Weight	Max Load Mounting On 1 Side Of Pole	Tilt	Dimensions
<b>BT5920</b>	75kg	N/A	N/A	Ø120 x 103mm
<b>BT5921</b>	75kg	25kg*	90°	150 x 70 x 63.5mm
<b>BT5922</b>	70kg	40kg*	90°	330 x 151 x 80mm
<b>BT5925</b>	25kg	25kg*	N/A	Ø120 x 833-1472mm

\*Max load if mounting on only one side of the pole. Max load of ceiling mount increases when mounting on both sides or the bottom of the pole.

**BT5909**  
**Small Dome Security Camera Mount**  
 for use with **BT5935** Ø38mm Poles



**BT5910**  
**Dome Security Camera Mount**  
 for use with **BT5935** Ø38mm Poles



**BT5911**  
**Large Dome Security Camera Mount**  
 for use with **BT5935** Ø38mm Poles

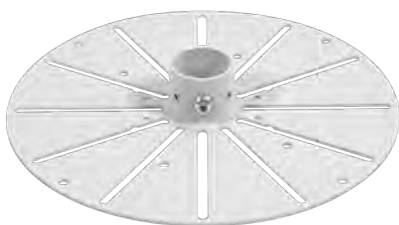

System V Camera Mounts			
Model Number	Max Load	Camera Fixings Dimensions	Plate Diameter
BT5909	5kg	51mm - 90mm	Ø120mm
BT5910	5kg	51mm - 127.5mm	Ø144mm
BT5911	5kg	51mm - 251.5mm	Ø268mm

■ Small ■ Medium ■ Large

## System V: Mounting Accessories

**BT5952**  
**Accessory Collar**  
 for use with **BT5935** Ø38mm Poles



Attach a range of B-Tech Screen Mounts to a System V Pole

**BT5951**  
**NPT Adaptor**  
 for use with **BT5935** Ø38mm Poles



Attach an NPT 1.5" (38mm) Security Camera to a System V Pole

**BT5950**  
 Ø38mm Pole Adaptor  
 to allow the use of **System 2**  
 Ø50mm Ceiling Mounts to  
 System V Poles



BT7825  
 Truss Clamp

**BT5953**  
**Pole Ring**  
 for use with **BT5935** Ø38mm Poles



# Surveillance & Security Mounting Solutions



**Complete mounting solutions designed to seamlessly install security cameras, flat screens, and CCTV systems in various public spaces, including retail, transportation, corporate, government, and leisure environments.**

Constructed using System V components, we have created a range of ready-made ceiling mount kits designed to cover some of our most popular installations. These kits offer options for pole mounting single dome cameras, a small to medium-sized flat screen, or a combination of both camera and screen. Tailored for use with System V's Ø38mm poles, these solutions are available in two lengths, utilising either a one or two-meter pole.

For a more custom approach, individual components within the System V range are available (*see page 152*). Poles can be joined together for an extended ceiling drop, and an adaptor is offered to enable the use of these components with B-Tech's versatile System 2 range. This flexibility allows CCTV installations onto I-Beams, Purlins, and Truss systems.

For complete product specifications, including technical drawings and colour options, scan each product's QR code to view the online page.

## Key Features

- Complete mounting kits to mount a dome security camera, a screen or both from the ceiling
- Available in a choice of two different drop lengths
- Multiple grub screws allow micro-adjustment of the pole to ensure a perfectly angled drop
- Safety bolts ensure pole and camera mount are securely joined for a safe installation
- Includes cover plates for a smart installation
- Integrated cable management allows cables to pass through the centre of the pole
- Components are also available to order individually



**Dome Camera  
Ceiling Mounts**



**Flat Screen  
Ceiling Mounts**



**Camera and Screen  
Ceiling Mounts**



# Camera & Screen Ceiling Mounts

■ **BT5960**  
**CCTV Ceiling Mount**  
 for small - medium  
 Dome Security Cameras



Available in 2 pole lengths

- BT5960-FD100 1m Pole
- BT5960-FD200 2m Pole

Adjustable Drop

- BT5960-AD 833-1472mm

Max Load	QR Code
5kg	

■ **BT5961**  
**CCTV Ceiling Mount**  
 for large Dome  
 Security Cameras

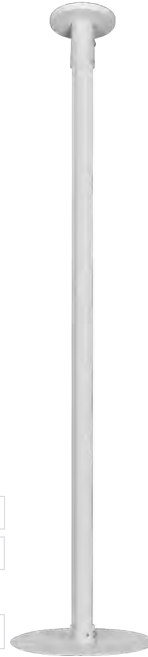

Available in 2 pole lengths

- BT5961-FD100 1m Pole
- BT5961-FD200 2m Pole

Adjustable Drop

- BT5961-AD 833-1472mm

Max Load	QR Code
5kg	

■ **BT5965**  
**CCTV Ceiling Mount**  
 with NPT Adaptor



Available in 2 pole lengths

- BT5965-FD100 1m Pole
- BT5965-FD200 2m Pole

Adjustable Drop

- BT5965-AD 833-1472mm

Max Load	QR Code
25kg	

## Flat Screen & Dome Camera Ceiling Mounting Kit

■ **BT5962**  
**CCTV Ceiling Mount**  
 Mounts a Flat Screen  
 and Dome Camera



Available in 2 pole lengths

- BT5962-FD100 1m Pole
- BT5962-FD200 2m Pole

Adjustable Drop

- BT5962-AD 833-1472mm

Recommended Max Screen	Max Load Screen	Max VESA	Max Load Camera
28" / 71cm	20kg	100	5kg
QR Code			

■ **BT5963**  
**CCTV Ceiling Mount**  
 Mounts a Flat Screen  
 with tilt and Dome Camera



Available in 2 pole lengths

- BT5963-FD100 1m Pole
- BT5963-FD200 2m Pole

Adjustable Drop

- BT5963-AD 833-1472mm

Recommended Max Screen	Max Load Screen	Max VESA	Tilt
28" / 71cm	20kg	100	10° / 17°
Max Load Camera		QR Code	
5kg			

■ **BT5964**  
**CCTV Ceiling Mount**  
 Mounts a Flat Screen  
 with tilt and Dome Camera



Available in 2 pole lengths

- BT5964-FD100 1m Pole
- BT5964-FD200 2m Pole

Adjustable Drop

- BT5964-AD 833-1472mm

Recommended Max Screen	Max Load Screen	Max VESA	Tilt
47" / 120cm	25kg	200	40° / 40°
Max Load Camera		QR Code	
5kg			



**BT5970**  
Flat Screen  
Ceiling Mount  
for VESA 100 Screens



Available in 2 pole lengths

- BT5970-FD100 1m Pole
- BT5970-FD200 2m Pole

Adjustable Drop

- BT5970-AD 833-1472mm

Recommended Max Screen	Max Load	Max VESA
28" (71cm)	20kg	100

**BT5971**  
Flat Screen  
Ceiling Mount with Tilt  
for VESA 100 Screens



Available in 2 pole lengths

- BT5971-FD100 1m Pole
- BT5971-FD200 2m Pole

Adjustable Drop

- BT5971-AD 833-1472mm

Recommended Max Screen	Max Load	Max VESA	Tilt
28" (71cm)	20kg	100	10° / 17°

**BT5972**  
Flat Screen  
Ceiling Mount with Tilt  
for VESA 200 Screens

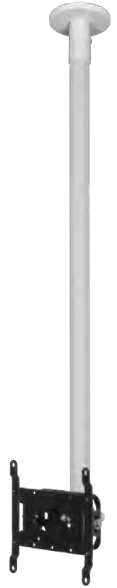

Available in 2 pole lengths

- BT5972-FD100 1m Pole
- BT5972-FD200 2m Pole

Adjustable Drop

- BT5972-AD 833-1472mm

Recommended Max Screen	Max Load	Max VESA	Tilt
47" (120cm)	40kg	200	40° / 40°

## Surveillance & Security Mounting Solutions

Model Number	Mount	Max Camera Weight	Camera Fixings	Max Screen Weight	Screen VESA	Recommended Screen Size	Screen Tilt	Ceiling Drop
BT5960-FD	Camera	5kg	51.5mm - 127.5mm	N/A	N/A	N/A	N/A	1m / 2m
BT5960-AD	Camera	5kg	51.5mm - 127.5mm	N/A	N/A	N/A	N/A	833-1472mm
BT5961-FD	Camera	5kg	51.5mm - 251.5mm	N/A	N/A	N/A	N/A	1m / 2m
BT5961-AD	Camera	5kg	51.5mm - 251.5mm	N/A	N/A	N/A	N/A	833-1472mm
BT5962-FD	Camera & Screen	5kg	51.5mm - 127.5mm	20kg	100	10"-28"	N/A	1m / 2m
BT5962-AD	Camera & Screen	5kg	51.5mm - 127.5mm	20kg	100	10"-28"	N/A	833-1472mm
BT5963-FD	Camera & Screen	5kg	51.5mm - 127.5mm	20kg	100	10"-28"	+17°-10°	1m / 2m
BT5963-AD	Camera & Screen	5kg	51.5mm - 127.5mm	20kg	100	10"-28"	+17°-10°	833-1472mm
BT5964-FD	Camera & Screen	5kg	51.5mm - 127.5mm	25kg	200	22"-47"	+/-40°	1m / 2m
BT5964-AD	Camera & Screen	5kg	51.5mm - 127.5mm	25kg	200	22"-47"	+/-40°	833-1472mm
BT5965-FD	Camera	25kg	NPT (1.5")	N/A	N/A	N/A	N/A	1m / 2m
BT5965-AD	Camera	25kg	NPT (1.5")	N/A	N/A	N/A	N/A	833-1472mm
BT5970-FD	Screen	N/A	N/A	20kg	100	10"-28"	N/A	1m / 2m
BT5970-AD	Screen	N/A	N/A	20kg	100	10"-28"	N/A	833-1472mm
BT5971-FD	Screen	N/A	N/A	20kg	100	10"-28"	+17°-10°	1m / 2m
BT5971-AD	Screen	N/A	N/A	20kg	100	10"-28"	+17°-10°	833-1472mm
BT5972-FD	Screen	N/A	N/A	25kg	200	22"-47"	+/-40°	1m / 2m
BT5972-AD	Screen	N/A	N/A	25kg	200	22"-47"	+/-40°	833-1472mm

	Product Code	Page Number
•	BT4000	150
•	BT4001	150
•	BT4002	150
•	BT4002-SCC	150
•	BT4002-SPC	150
•	BT4002-TCC	150
•	BT4002-TPC	150
•	BT4107	151
•	BT4116	151
•	BT4118	151
•	BT5226	61
•	BT5227	63
•	BT5431	60
•	BT5432	62
•	BT5441	60
•	BT5442	62
•	BT5909	157
•	BT5910	157
•	BT5911	157
•	BT5920	156
•	BT5921	156
•	BT5922	156
•	BT5923	156
•	BT5925	156
•	BT5935	156
•	BT5950	157
•	BT5951	157
•	BT5952	157
•	BT5953	157
•	BT5960-AD	160
•	BT5960-FD	160
•	BT5961-AD	160
•	BT5961-FD	160
•	BT5962-AD	160
•	BT5962-FD	160
•	BT5963-AD	160
•	BT5963-FD	160
•	BT5964-AD	160
•	BT5964-FD	160
•	BT5965-AD	160
•	BT5965-FD	160
•	BT5970-AD	161

	Product Code	Page Number
•	BT5970-FD	161
•	BT5971-AD	161
•	BT5971-FD	161
•	BT5972-AD	161
•	BT5972-FD	161
•	BT6010	145
•	BT7000	50
•	BT7001	50
•	BT7002	50
•	BT7003	52
•	BT7004	52
•	BT7012	142
•	BT7017	142
•	BT7027	151
•	BT7031	102
•	BT7032	101
•	BT7033	101
•	BT7034	102
•	BT7051	143
•	BT7052	143, 151
•	BT7055	144
•	BT7056	144
•	BT7104	52
•	BT7351	71
•	BT7352	71
•	BT7353	71
•	BT7355	73
•	BT7356	73
•	BT7371	72
•	BT7372	72
•	BT7373	72
•	BT7374	72
•	BT7383	72
•	BT7399	72
•	BT7502	65
•	BT7504	77
•	BT7510	56
•	BT7511	56
•	BT7512	56
•	BT7513	56
•	BT7514	59
•	BT7515	59

	Product Code	Page Number
•	BT7518	56
•	BT7523	58
•	BT7532	58
•	BT7540	65
•	BT7542	65
•	BT7550	49
•	BT7550-SF2	76
•	BT7551	144
•	BT7553	67, 71
•	BT7564	65
•	BT7565	65
•	BT7592	57
•	BT7593	57
•	BT7594	57
•	BT77	103
•	BT7780	99
•	BT7781	100
•	BT7807	141
•	BT7808	141
•	BT7822	141
•	BT7823	140
•	BT7824	140
•	BT7825	142
•	BT7831	142
•	BT7832	144
•	BT7841	143, 151
•	BT7850	140
•	BT7851	141
•	BT7852	143
•	BT7853	140
•	BT7863	100
•	BT7865	101
•	BT7866	100
•	BT7870	106
•	BT7871	106
•	BT7873	106
•	BT7874	106
•	BT7875	100, 106
•	BT7876	107
•	BT7877	107
•	BT7878	100, 107
•	BT7879	107
•	BT7883	98

	Product Code	Page Number
•	BT7883-TRAY	98
•	BT7884	90
•	BT7884-TRAY	90
•	BT7885	98
•	BT7885-TRAY	98
•	BT7886	100
•	BT7888	99
•	BT7889	99
•	BT7901	52
•	BT8200	58
•	BT8226	61
•	BT8227	63
•	BT8228	64
•	BT8229	61
•	BT8301	45
•	BT8309	45
•	BT8310XL	45
•	BT8312	44
•	BT8322	49
•	BT8325	51
•	BT8326	51
•	BT8327	51
•	BT8330	36
•	BT8331	36
•	BT8332	36
•	BT8333	36
•	BT8340	37
•	BT8341	37
•	BT8342	37
•	BT8343	37
•	BT8370	38
•	BT8371	38
•	BT8372	38
•	BT8373	39
•	BT8374	39
•	BT8375	39
•	BT8376	39
•	BT8377	38
•	BT8380	127
•	BT8380-AFB	128
•	BT8380-BASE	128
•	BT8380-CASTORS	128
•	BT8380-EXTV	127

	Product Code	Page Number
●	BT8380-FFB	128
●	BT8380-FFT	131
●	BT8380-FSB	128
●	BT8380-JPK	127
●	BT8380-JPR	127
●	BT8380-JPT	127
●	BT8380-RFB	128
●	BT8380-SHB	128
●	BT8380-WTB	131
●	BT8381	151
●	BT8381-FFB	150
●	BT8381-JPS	151
●	BT8390	126
●	BT8390-AAC	131
●	BT8390-CFK	131
●	BT8390-CMC	131
●	BT8390-EXT	126
●	BT8390-RCL	131
●	BT8390-RCP	131
●	BT8390-SA	102, 130
●	BT8390-VESA1200F	130
●	BT8390-VESA200F	129
●	BT8390-VESA200T	129
●	BT8390-VESA400F	129
●	BT8390-VESA400MAF	129
●	BT8390-VESA400MAP	129
●	BT8390-VESA400T	129
●	BT8390-VESA600F	130
●	BT8390-VESA800F	130
●	BT8390-WFK1	126
●	BT8390-WFK2	126
●	BT8390-WFK3	126
●	BT8390-WFK4	126
●	BT8390-WFK5	126
●	BT8390-WFK6	126
●	BT8390-WFK8	126
●	BT83LAEC015-B	33
●	BT83LAEC015-M	33
●	BT83LAEC015-S	33
●	BT83LG163-B	33
●	BT83LG163-M	33
●	BT83LG163-S	33

	Product Code	Page Number
●	BT83LG171-B	33
●	BT83LG171-M	33
●	BT83LG171-S	33
●	BT8415	87
●	BT8416	87
●	BT8420	67
●	BT8424	67
●	BT8426	68
●	BT8427	68
●	BT8428	68
●	BT8431	60
●	BT8432	62
●	BT8441	60
●	BT8442	62
●	BT8443	63
●	BT8448	69
●	BT8449	69
●	BT8503	77
●	BT8504	77
●	BT8506	77
●	BT8511	85
●	BT8514	85
●	BT8516	85
●	BT8517	86
●	BT8518	86
●	BT8521	84
●	BT8527	86
●	BT8528	86
●	BT8537	86
●	BT8538	86
●	BT8540	79
●	BT8541	79
●	BT8545	78
●	BT8546	78
●	BT8558	80
●	BT8559	80
●	BT8562	76
●	BT8564	76
●	BT8566	76
●	BT8568	80
●	BT8569	81
●	BT856-FEET	76

	Product Code	Page Number
●	BT8570	82
●	BT8571	82
●	BT8572	82
●	BT8573	82
●	BT8577	53
●	BT8581	82
●	BT8582	82
●	BT8583	82
●	BT8587	53
●	BT8590	79
●	BT8700	90
●	BT8701	90
●	BT8702	90
●	BT8703	91
●	BT8704	91
●	BT8705	91
●	BT8706	91
●	BT8707	92
●	BT8708	92
●	BT8709	92
●	BT8710	92
●	BT8711	93
●	BT8712	93
●	BT893	111, 145
●	BT893-AD	111
●	BT893-FD	111
●	BT899	110, 145
●	BT899-AD	110
●	BT899-FD	110
●	BT899XL	110, 145
●	BT899XL-AD	110
●	BT899XL-FD	110
●	BT9240	30
●	BT9242	31
●	BT9244	31
●	BT9270	30
●	BT9271	30
●	BT9272	31
●	BT9340	22
●	BT9342	22
●	BT9343	24
●	BT9344	22

	Product Code	Page Number
●	BT9350	25
●	BT9351	25
●	BT9352	25
●	BT9370	23
●	BT9370-SAM110	32
●	BT9370-SAM130	32
●	BT9370-SAM146	32
●	BT9371	23
●	BT9372	23
●	BT9372-SAM110	32
●	BT9372-SAM130	32
●	BT9372-SAM146	32
●	BT9373	24
●	BT9375	24
●	BT9376	25
●	BT9377	23
●	BT9378	25
●	BT9901	64
●	BT9903	64
●	BT9910	64
●	BT9920	48
●	BT9921	48
●	BT9922	48
●	BT9923	49
●	BT9925	48
●	BT9926	48
●	BTF840	83
●	BTF841	84
●	BTF842	84
●	BTF843	83
●	BTF845	84
●	BTV500	58
●	BTV502	58
●	BTV503	59
●	BTV504	59
●	BTV510	60
●	BTV513	60
●	BTV520	62
●	BTV914	103
●	BTW075-4	91
●	BTXPS27-B	29
●	BTXPS27-M	29
●	BTXPS27-S	28
●	BTXPS27-W	28

**United Kingdom**  
+44 (0)1327 300 787  
uk@btechavmounts.com

**Europe**  
+32 (0)2 720 9271  
europe@btechavmounts.com

**Germany**  
+49 (0)2162-5483032  
dach@btechavmounts.com

**Spain**  
+34 93 640 24 79  
iberia@btechavmounts.com

**Americas**  
+1 888 792 8188  
americas@btechavmounts.com

**MEAI**  
+971 4 3574855  
meai@btechavmounts.com

**APAC**  
+65 3159 1604  
apac@btechavmounts.com

**China**  
(+86) 574 8810 3861  
china@btechavmounts.com

**South Korea**  
+82 (0) 2 862 3165  
korea@btechavmounts.com

**Vietnam**  
+84 (0)24 3201 3418  
vietnam@btechavmounts.com

For full details of all B-Tech offices, please visit [www.btechavmounts.com/contact-us](http://www.btechavmounts.com/contact-us) or scan here:



© 2024 December B-Tech AV Mounts Corporation Ltd., All rights reserved.

The information in this catalogue reflects the current technical specifications at the time of print. We reserve the right to change the technical or physical specifications without prior notice. System X, System Xpert, System Xpress, System 2 & System V are trademarks of B-Tech AV Mounts Corporation Ltd., B-Tech AV Mounts, the B-Tech logo, Ventry & Mode-AL are all registered trademarks. All B-Tech images & symbols are exclusive property of B-Tech AV Mounts Corporation Ltd. All other brands & products are trademarks of their respective owners. B-Tech accept no liability for loss or damage caused by improper installation or mounting on unstable structures. E&OE.

#### Disclaimer

B-Tech security fasteners are designed as a security deterrent only. B-Tech, B-Tech distributors & B-Tech resellers accept no liability for loss or resulting costs incurred from the theft, attempted theft or unauthorised removal of any item(s) mounted using B-Tech security fasteners. Security screw removal tools are widely available & all B-Tech security fasteners are intended as a deterrent to the opportunist thief only.

B-Tech AV Mounts is part of the



GLOBAL MOUNTS GROUP

[www.globalmountsgroup.com](http://www.globalmountsgroup.com)

  
Designed & Engineered  
in the UK

CA-2024-V1-131224-ENG