

DMX-RT4

User Manual





Edition Notes

The DMX-RT4 User Manual includes a description, safety precautions, installation, programming, operation, and maintenance instructions for the DMX-RT4 as of the release date of this edition.

Trademarks

Chauvet, Chauvet DJ, the Chauvet logo, and DMX are registered trademarks or trademarks of Chauvet & Sons, LLC (d/b/a Chauvet and Chauvet Lighting) in the United States and other countries. Other company and product names and logos referred to herein may be trademarks of their respective companies.

Copyright Notice

The works of authorship contained in this manual, including, but not limited to, all designs, text, and images are owned by Chauvet.

© Copyright 2024 Chauvet & Sons, LLC. All rights reserved.

Electronically published by Chauvet in the United States of America.

Manual Use

Chauvet authorizes its customers to download and print this manual for professional information purposes only. Chauvet expressly prohibits the usage, copy, storage, distribution, modification, or printing of this manual or its content for any other purpose without written consent from Chauvet.

Document Printing

For best results, print this document in color, on letter size paper (8.5 x 11 in), double-sided. If using A4 paper (210 x 297 mm), configure the printer to scale the content accordingly.

Intended Audience

Any person installing, operating, and/or maintaining this product should completely read through the guide that shipped with the product, as well as this manual, before installing, operating, or maintaining this product.

Disclaimer

Chauvet believes that the information contained in this manual is accurate in all respects. However, Chauvet assumes no responsibility and specifically disclaims any and all liability to any party for any loss, damage, or disruption caused by any errors or omissions in this document, whether such errors or omissions result from negligence, accident, or any other cause. Chauvet reserves the right to revise the content of this document without any obligation to notify any person or company of such revision; however, Chauvet has no obligation to make, and does not commit to make, any such revisions.

Document Revision

Go to www.chauvetdj.com for the latest version.

Revision	Date	Description
1	02/2024	Initial release.

TABLE OF CONTENTS

1. Before You Begin	1
What Is Included	1
Unpacking Instructions	1
Claims	1
Text Conventions	1
Symbols	1
Safety Notes	2
2. Introduction	3
Product Overview	3
Product Dimensions	4
3. Setup	5
AC Power	5
AC Plug	5
Connecting Diagram	5
Triggers	6
Trigger Diagram	6
Mounting	7
Orientation	7
Rigging	7
4. Operation	8
Control Panel Operation	8
Menu Map	8
Mass Storage	11
Transfer Files	11
Standalone Configuration	12
Play Audio	12
Delete Audio	12
Play Show	12
Record Show	13
Delete Show	13
Trigger Event	14
Stop TR Event	16
Enter Mass Storage	16
Lock Device	16
Device Settings	17
Save Configuration	18
Load Configuration	18
Default Setting	18
5. Maintenance	19
Product Maintenance	19
6. Technical Specifications	20
Contact Us	21
Warranty & Returns	21

1. Before You Begin

What Is Included

- DMX-RT4
- External power supply
- Quick Reference Guide

Unpacking Instructions

Carefully unpack the product immediately and check the container to make sure all the parts are in the package and are in good condition.

Claims





If the box or the contents (the product and included accessories) appear damaged from shipping, or show signs of mishandling, notify the carrier immediately, not Chauvet. Failure to report damage to the carrier immediately may invalidate a claim. In addition, keep the box and contents for inspection.

For other issues, such as missing components or parts, damage not related to shipping, or concealed damage, file a claim with Chauvet within 7 days of delivery.

Text Conventions

Convention	Meaning
1–512	A range of values
50/60	A set of values of which only one can be chosen
Settings	A menu option not to be modified
<ENTER>	A key to be pressed on the product’s control panel
ON	A value to be entered or selected

Symbols

Symbol	Meaning
	Electrical warning. Not following these instructions may cause electrical damage to the product, accessories, or the user.
	Critical installation, configuration, or operation information. Not following these instructions may make the product not work, cause damage to the product, or cause harm to the operator.
	Important installation or configuration information. The product may not function correctly if this information is not used.
	Useful information.

Safety Notes

These Safety Notes include important information about installation, use, and maintenance of the DMX-RT4.



■ **ALWAYS:**

- ◆ Connect to a grounded circuit.
- ◆ Connect to operating voltages as specified on the product's spec sticker.
- ◆ Use a safety cable when suspending overhead.
- ◆ Heed all restrictions and warnings on the spec sticker.
- ◆ Mount in a location with at least 20 in (50 cm) of ventilation.
- ◆ Use a clamp with a captive bolt when a single hanging bracket is used.

- In the event of a serious operating problem, stop using immediately.

■ **DO NOT:**

- ◆ Open this product or attempt any repairs. It contains no user-serviceable parts.
- ◆ Use if the power cable is crimped or damaged.
- ◆ Disconnect by pulling on the power cable.
- ◆ Allow flammable materials close to the product when it is operating.
- ◆ Connect to a dimmer or rheostat.
- ◆ Carry the product by its power cable.
- ◆ Operate in temperatures higher than 104°F (40°C).
- ◆ Expose to environments that exceed the Ingress Protection (IP) rating.
- ◆ Expose to rain or moisture.
- ◆ Use outdoors.
- ◆ Submerge.
- ◆ Leave outdoors for extended periods of time.
- ◆ Expose to corrosive environmental conditions such as temperature, humidity, salinity, pressure, radiation, or shock.
- ◆ Set this product on a flammable surface.



Keep this User Manual for future use. If the product is sold to someone else, be sure that they also receive this document.

2. Introduction

Product Overview

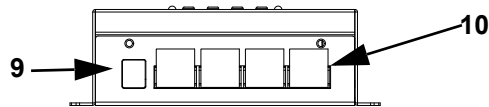
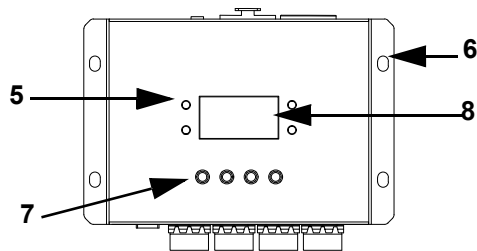
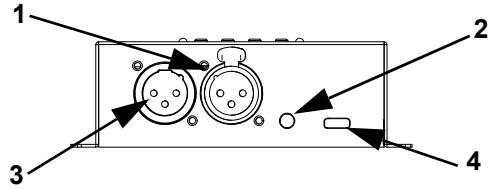

Color	Status	Function
Green	Steady	File is playing
	Blinking	Show is recording
Blue	Steady	Trigger has been activated
	Blinking	DMX input detected
Red	Steady	Power ON
	Blinking	N/A
Yellow	Steady	SD activity in progress
	Blinking	SD activity in progress

#	Description
1	DMX out
2	Audio out
3	DMX in
4	USB port
5	Status indicator lights
6	Mounting points
7	Menu buttons
8	OLED Screen
9	DC power in
10	Phoenix connectors/ triggers

Product Dimensions

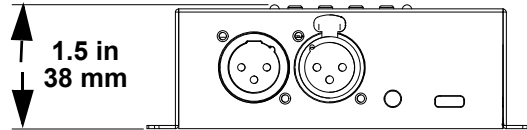
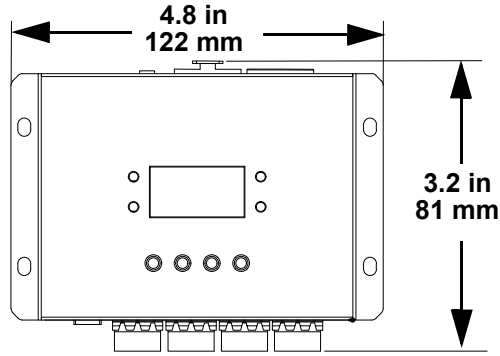

3. Setup

AC Power

The DMX-RT4 has an external power supply and it can work with an input voltage range of 100 to 240 VAC, 50/60 Hz.

To determine the product's power requirements (circuit breaker, power outlet, and wiring), use the current value listed on the label affixed to the product's back panel, or refer to the product's specifications chart. The listed current rating indicates the product's average current draw under normal conditions.



- **Always connect the product to a protected circuit (a circuit breaker or fuse). Make sure the product has an appropriate electrical ground to avoid the risk of electrocution or fire.**
- **To eliminate unnecessary wear and improve its lifespan, during periods of non-use completely disconnect the product from power via breaker or by unplugging it.**



Never connect the product to a rheostat (variable resistor) or dimmer circuit, even if the rheostat or dimmer channel serves only as a 0 to 100% switch.

AC Plug

Connection	Wire (U.S.)	Wire (Europe)	Screw Color
AC Live	Black	Brown	Yellow/Brass
AC Neutral	White	Blue	Silver
AC Ground	Green/Yellow	Green/Yellow	Green/Silver

Connecting Diagram

The DMX-RT4 has 4 3-pin Phoenix connectors which connect the device to triggers, which may require additional power. See below for demonstrative purposes:

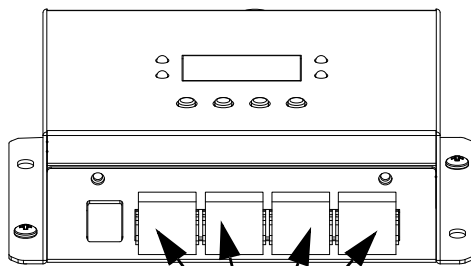

Phoenix Connectors

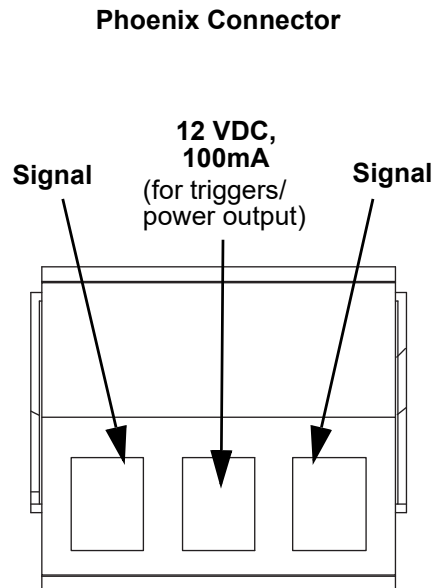

Phoenix Connector

Triggers

The DMX-RT4 has phoenix connectors which users can connect to triggers (See [Connecting Diagram](#)). Programming options on the device then allow users to:

- Set triggers to play a preset show or audio file
- Assign each trigger a different name
- Give triggers higher or lower priority over others
- Enabled or disable each trigger

Trigger Diagram

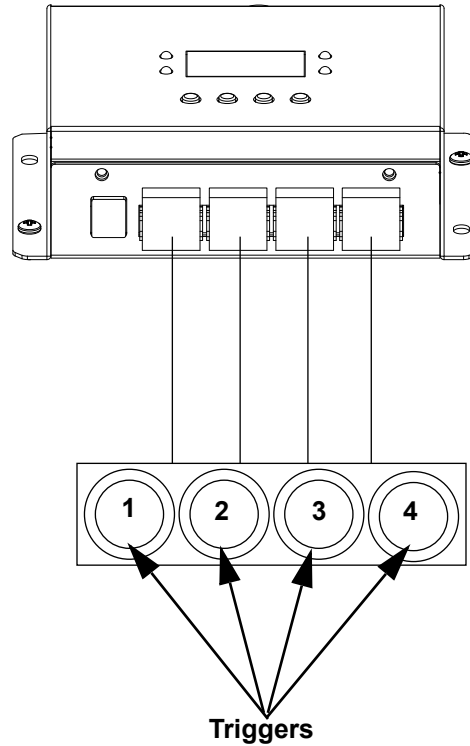

For further information on how to use/program triggers with the DMX-RT4, see the [Standalone Configuration](#) section of this manual.

Mounting

Before mounting the product, read and follow the safety recommendations indicated in the [Safety Notes](#).

Orientation

The DMX-RT4 may be mounted in any position; however, make sure adequate ventilation is provided around the product.

Rigging

- Before deciding on a location for the product, always make sure there is easy access to the product for maintenance and programming.
- Make sure that the structure and attachment points can support the weight before hanging the product (see the [Technical Specifications](#))
- When power linking multiple products, mount the products close enough for power linking cables to reach.
- When mounting the product on the floor, make sure that the product and cables are away from people and vehicles.

Mounting Diagram

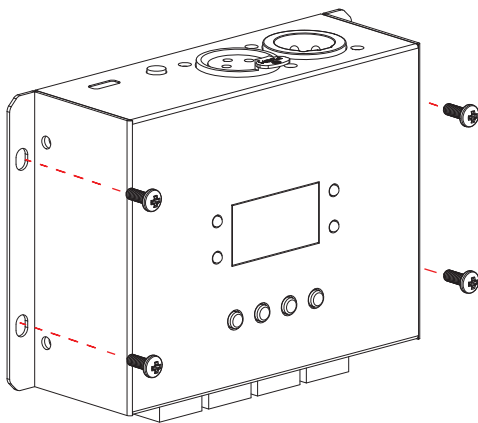

Wall Mounting

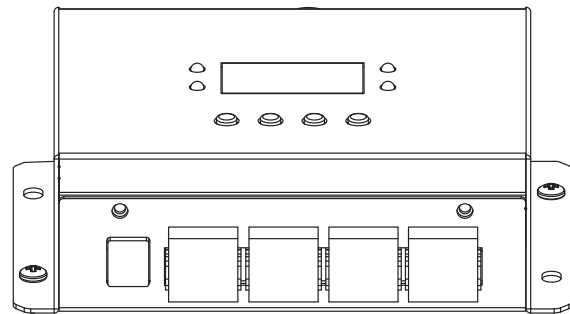

Surface Mounting



Using a Philips-head or flat-head screwdriver, mount the DMX-RT4 to any wall using both screws and studs.

4. Operation

Control Panel Operation

To access the control panel functions, use the four buttons located underneath the display. Please refer to the [Product Overview](#) to see the button locations on the control panel.

Button	Function
<MENU>	Press to find an operation mode or to back out of the current menu option
<UP>	Press to scroll up the list of options or to find a higher value
<DOWN>	Press to scroll down the list of options or to find a lower value
<ENTER>	Press to activate a menu option or a selected value

Menu Map

Refer to the DMX-RT4 product page on www.chauvetdj.com for the latest menu map.

Main Level	Programming Levels		Description	
1. Play Audio	Audio	–	Selects audio file (12 character max)	
	Mode	One Play	Sets audio to play once or loop	
		Loop Play		
	Start Play	Stop Play (If audio file selected)	Enables/ disables audio	
Return (If audio file not selected)				
2. Delete Audio	–	Delete Audio	Continue Return	Delete audio file or return to previous menu
3. Play Show	Show	–		Selects saved show file to play
	Mode	One Play		Sets show to play once or on repeat
		Loop Play		
	Start Play	Stop Play (When show is selected)		
Return (When show is not selected)				
4. Record Show	Name	-----		Customize name for file to be recorded (11 character max)
		Cancel		
		Enter		
	Mode	Manual		Records via manual command
		Auto		Records upon recognizing DMX signal
Start Record	Manual Start (When Start Record is selected in Manual Mode or Semi_Auto Mode)		Starts recording show	
	Stop Record (When Start Record is selected in Auto Mode or Manual Record is selected in Manual or Semi_Auto Mode)			
5. Delete Show	–	Delete Show	Continue Return	Deletes selected show/Return to Main Menu

Main Level	Programming Levels		Description	
6. Trigger Event	1. Trigger 1 2. Trigger 2 3. Trigger 3 4. Trigger 4 (The higher the trigger, the higher the priority)	1. Status	Enable	Enables/ disables trigger
			Disable	
		2. Rename	-----	Renames the trigger
			--	
			Cancel	
		3. Show List	Enter	Select show file(s) for trigger
			All Show File	
		4. DMX	Once	Play once or on repeat
			Loop	
		5. Audio	-	Select audio file(s) for trigger
		6. MP3	Once	Set trigger audio to play once or on repeat
			Loop	
		7. Mode	NO_TR	Does not trigger until circuit is closed
			AUTO_TR	Automatically triggers
TOGGLE_TR	Sets each trigger to on/off			
NC_TR	Does not trigger until circuit is open			
8. Delay	000-120	Sets trigger delay		
9. Interrupt	Self	Can be interrupted only by same trigger		
	Priority	Only higher numbered triggers can interrupt		
	On	Any other trigger can interrupt		
	Off	Cannot be interrupted		
	Self+Prio	Can be interrupted by Self or higher priority		
10. Restart	Enable	When show is interrupted by a higher-priority trigger, the playback will restart from the beginning when the higher-priority show has finished.		
	Disable	When show is interrupted by a higher-priority trigger, playback will resume from the point of interruption when the higher-priority show has finished.		
11. Save		Save parameters for trigger		
12. Cancel		Cancel parameters for trigger		
7. Stop TR Event	1. Trigger 1	Stop (when trigger 1 is playing)	Manually stops trigger 1	
	2. Trigger 2	Stop (When trigger 2 is playing)	Manually stops trigger 2	
	3. Trigger 3	Stop (When trigger 3 is playing)	Manually stops trigger 3	
	4. Trigger 4	Stop (When trigger 4 is playing)	Manually stops trigger 4	
8. Enter MassStorage	1. Connect to PC	-	Allows user to transfer audio/ update firmware	
		Return		
	2. Format SD Card	Continue Return	Format SD card/ return	

Main Level	Programming Levels		Description	
9. Lock Device	1. PIN	000–999	Sets PIN code to unlock device	
	2. Lock	Disable	Disables lock/ sets lock to 30 sec timer	
		Timeout		
	3. Manual lock	PIN	000–999	Select PIN code to unlock device
Unlock		Unlocks device w/ preset PIN		
10. Device Settings	1. Device Label	-----	Sets device label on timeout screen	
		Cancel		
		Enter		
	2. DMX Trigger Option	1. Trigger	ENABLE	Allows DMX signal to trigger 4 scenes
			DISABLE	
	3. Display Option	1. Mode	Normal	Enables/disables inverted display
			Inverse	
		2. Backlight	On	Enables/disables timer for display blackout
0–60				
4. Version	CPU1: _ _ . _ V _ . _		Displays software version	
11. Save Configuration	Name	-----	Sets name for the current configuration	
		Cancel		
		Enter		
Backup Data	Return (upon successful backup)		Saves current configuration	
12. Load Configuration	-	Restore	Selects configuration to be loaded	
		Del		
13. Default Setting	Yes		Restores ALL settings to default	
	No			



If the user forgets the preset manual lock PIN, the master unlock PIN is 996.

Mass Storage

It is possible to copy, backup, and transfer show files to and from the DMX-RT4 using the USB-C connection. To enter Mass Storage:

1. Connect the DMX-RT4 to a PC with a USB-C cable.
2. Select **Enter MassStorage** on the device.



For further instruction how to connect the device to a PC, see [Enter Mass Storage](#).

3. Once connected, identify the device on the PC.

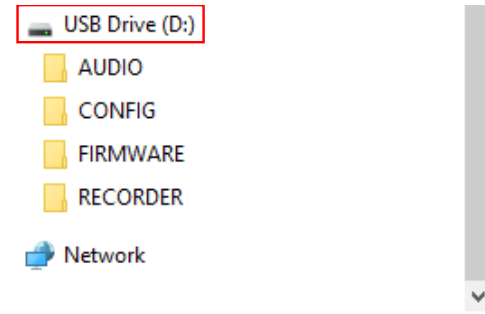

Transfer Files

To transfer files:

1. Identify the type of file to be transferred and open the corresponding folder.

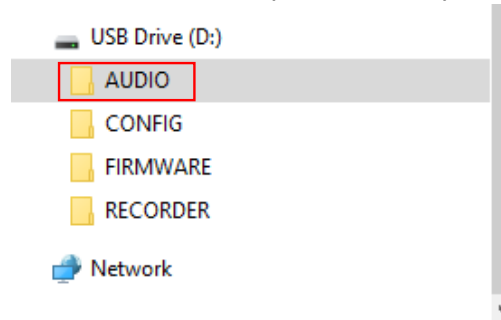

2. Locate the file on the PC.

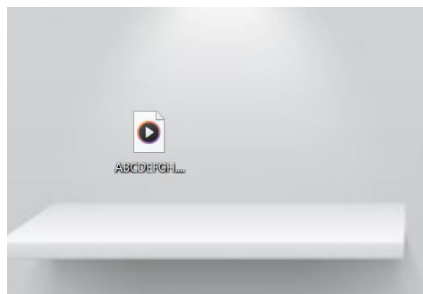

3. Copy and paste or drag and drop the file from the PC to the folder.

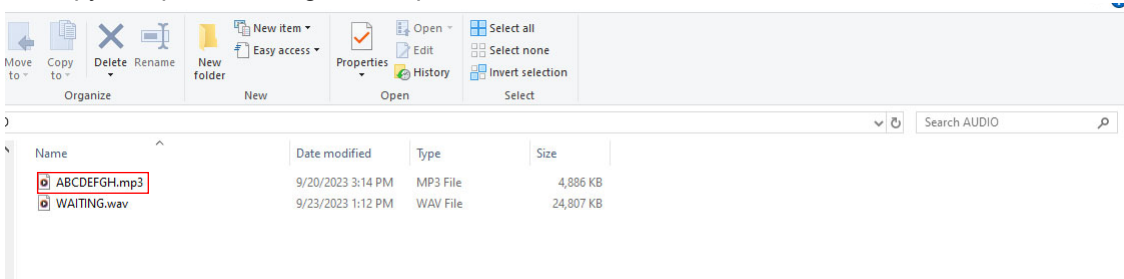

4. Configurations, firmware, and recordings may also be moved with the same steps.

Standalone Configuration

Set the product in one of the standalone modes to operate without a DMX controller.



Never connect a product that is operating in any standalone mode to a DMX string connected to a DMX controller. Products in standalone mode may transmit DMX signals that could interfere with the DMX signals from the controller.

Play Audio

To select an audio file to play on the DMX-RT4, follow the instructions below.

1. Press **<MENU>** repeatedly until **Play Audio** shows on the display.
2. Press **<ENTER>**.
3. Use **<UP>** or **<DOWN>** to select **Audio**.
4. Press **<ENTER>**.
5. Use **<UP>** or **<DOWN>** to select the desired audio file.
6. Press **<ENTER>**.

To set the frequency of play for the selected audio file:

1. Press **<MENU>** repeatedly until **Play Audio** shows on the display.
2. Press **<ENTER>**.
3. Use **<UP>** or **<DOWN>** to select **Mode**.
4. Press **<ENTER>**.
5. Use **<UP>** or **<DOWN>** to select **One Loop** (to play the audio file once) or **Loop Play** (to play the audio file repeatedly).
6. Press **<ENTER>**.

To play, pause, or return to the previous menu:

1. Press **<MENU>** repeatedly until **Play Audio** shows on the display.
2. Press **<ENTER>**.
3. Use **<UP>** or **<DOWN>** to select **Start Play** (begins playing the selected file).
4. Press **<ENTER>**.
5. Use **<UP>** or **<DOWN>** to select **Stop Play** (to pause the audio file) or **Return** (to return to the previous menu).
6. Press **<ENTER>**.

Delete Audio

To delete an audio file:

1. Press **<MENU>** repeatedly until **Delete Audio** shows on the display.
2. Press **<ENTER>**.
3. Use **<UP>** or **<DOWN>** to select an audio file to delete.
4. Press **<ENTER>**.
5. Select **Delete Audio** and press **<ENTER>**.
6. Use **<UP>** or **<DOWN>** to select **Continue** (to delete the audio file) or **Return** (to return to the previous menu).
7. Press **<ENTER>**.

Play Show

To select a show:

1. Press **<MENU>** repeatedly until **Play show** shows on the display.
2. Press **<ENTER>**.
3. Use **<UP>** or **<DOWN>** to select **Show**.
4. Press **<ENTER>**.
5. Use **<UP>** or **<DOWN>** to select a show to play.
6. Press **<ENTER>**.

To select the frequency of play for the selected show:

1. Press **<MENU>** repeatedly until **Play show** shows on the display.
2. Press **<ENTER>**.
3. Use **<UP>** or **<DOWN>** to select **Mode**.
4. Press **<ENTER>**.
5. Use **<UP>** or **<DOWN>** to select **One Play** (to play the show once) or **Loop play** (to play the show repeatedly).
6. Press **<ENTER>**.

To play the selected show:

1. Press **<MENU>** repeatedly until **Play show** shows on the display.
2. Press **<ENTER>**.
3. Use **<UP>** or **<DOWN>** to select **Start Play**.
4. Press **<ENTER>**.
5. Use **<UP>** or **<DOWN>** to select **Stop Play** (to pause play if a show is selected) or **Return** (to return to the previous screen).
6. Press **<ENTER>**.

Record Show

To select a name for a show:

1. Press **<MENU>** repeatedly until **Record Show** shows on the display.
2. Press **<ENTER>**.
3. Use **<UP>** or **<DOWN>** to select **Name**.
4. Press **<ENTER>**.
5. Use **<UP>** or **<DOWN>** to select _____ (to customize the file name), **Cancel** (to cancel) or **Enter** (to save the show name).
6. Press **<ENTER>**.

To select a recording mode:

1. Press **<MENU>** repeatedly until **Record Show** shows on the display.
2. Press **<ENTER>**.
3. Use **<UP>** or **<DOWN>** to select **Mode**.
4. Press **<ENTER>**.
5. Use **<UP>** or **<DOWN>** to select **Manual** (to record the show via manual command), **Auto** (to record upon DMX signal) or **Semi_Auto** (to record via manual command and stop automatically).
6. Press **<ENTER>**.

To begin or stop recording the show:

1. Press **<MENU>** repeatedly until **Record Show** shows on the display.
2. Press **<ENTER>**.
3. Use **<UP>** or **<DOWN>** to select **Start Record**.
4. Press **<ENTER>**.
5. Use **<UP>** or **<DOWN>** to select **Manual Start** (When **Start Record** is selected in **Manual Mode** or **Semi Auto Mode**) or **Stop Record** (When **Start Record** is selected in **Auto Mode** or **Manual Record** is selected in **Manual** or **Semi Auto Mode**).
6. Press **<ENTER>**.

Delete Show

To delete a show:

1. Press **<MENU>** repeatedly until **Delete Show** shows on the display.
2. Press **<ENTER>**.
3. Use **<UP>** or **<DOWN>** to select the desired show.
4. Press **<ENTER>**.
5. Select **Delete Show**.
6. Press **<ENTER>**.
7. Use **<UP>** or **<DOWN>** to select **Continue** (to delete the selected show), or **Return** (to return to the main menu).

Operation

Trigger Event

To select a trigger:

1. Press **<MENU>** repeatedly until **Trigger Event** shows on the display.
2. Press **<ENTER>**.
3. Use **<UP>** or **<DOWN>** to select the desired trigger, from **Trigger 1**, **Trigger 2**, **Trigger 3**, or **Trigger 4**.
4. Press **<ENTER>**.

To enable or disable a trigger:

1. Select a Trigger from the [Trigger Event](#) menu.
2. Use **<UP>** or **<DOWN>** to select **Status**.
3. Press **<ENTER>**.
4. Use **<UP>** or **<DOWN>** to select **Enable** or **Disable**.
5. Press **<ENTER>**.

To rename a trigger:

1. Select a Trigger from the [Trigger Event](#) menu.
2. Use **<UP>** or **<DOWN>** to select **Rename**.
3. Press **<ENTER>**.
4. Use **<UP>** or **<DOWN>** to select _____ (select from 11 max spaces to rename the trigger).
5. Press **<ENTER>**.
6. Use **<UP>** or **<DOWN>** to select **Cancel** (to return to the previous menu), or **Enter** (to save the trigger name).
7. Press **<ENTER>**.

To pair a show with a trigger:

1. Select a Trigger from the [Trigger Event](#) menu.
2. Use **<UP>** or **<DOWN>** to select **Show list**.
3. Press **<ENTER>**.
4. Use **<UP>** or **<DOWN>** to select a show file from the list.
5. Press **<ENTER>**.
6. Use **<UP>** or **<DOWN>** to select a show file to add to the list.
7. Press **<ENTER>** to add the file to the selected show list.

To pair the DMX with a specific trigger:

1. Select a Trigger from the [Trigger Event](#) menu.
2. Use **<UP>** or **<DOWN>** to select **DMX**.
3. Press **<ENTER>**.
4. Use **<UP>** or **<DOWN>** to select **Once** (to play once) or **Loop** (to play repeatedly).
5. Press **<ENTER>**.

To pair a audio with a trigger:

1. Select a Trigger from the [Trigger Event](#) menu.
2. Use **<UP>** or **<DOWN>** to select **Audio**.
3. Press **<ENTER>**.
4. Use **<UP>** or **<DOWN>** to select an audio file.
5. Press **<ENTER>**.

To pair an MP3 file with a trigger:

1. Select a Trigger from the [Trigger Event](#) menu.
2. Use **<UP>** or **<DOWN>** to select **MP3**.
3. Press **<ENTER>**.
4. Use **<UP>** or **<DOWN>** to select **Once** (to play once) or **Loop** (to play repeatedly).
5. Press **<ENTER>**.

To select the mode for the trigger:

1. Select a Trigger from the [Trigger Event](#) menu.
2. Use **<UP>** or **<DOWN>** to select **Mode**.
3. Press **<ENTER>**.
4. Use **<UP>** or **<DOWN>** to select **NO_TR** (Does not trigger until circuit is closed), **AUTO_TR** (Automatic trigger), **TOGGLE TR** (Sets each trigger to on/off), or **NC_TR** (Does not trigger until circuit is open).
5. Press **<ENTER>**.

To program the trigger with a delay:

1. Select a Trigger from the [Trigger Event](#) menu.
2. Use **<UP>** or **<DOWN>** to select **Delay**.
3. Press **<ENTER>**.
4. Use **<UP>** or **<DOWN>** to select a delay time from **000–120** (seconds).
5. Press **<ENTER>**.

To set/allow interruptions for the trigger:

1. Select a Trigger from the [Trigger Event](#) menu.
2. Use **<UP>** or **<DOWN>** to select **Interrupt**.
3. Press **<ENTER>**.
4. Use **<UP>** or **<DOWN>** to select a delay time from **Self** (interrupted by self), **Priority** (can be interrupted by higher priority triggers), **On** (any other trigger can interrupt), **Off** (cannot be interrupted), **Self + Prio** (Can be interrupted by self or higher priority).
5. Press **<ENTER>**.

Once a trigger interrupts a show, the previous show may be played again. To set the selected trigger playback:

1. Select a Trigger from the [Trigger Event](#) menu.
2. Use **<UP>** or **<DOWN>** to select **Restart**.
3. Press **<ENTER>**.
4. Use **<UP>** or **<DOWN>** to select **Enable** (show will restart from the beginning) or **Disable** (show will resume from point of interruption).
5. Press **<ENTER>**.

To save parameters for a selected trigger:

1. Select a Trigger from the [Trigger Event](#) menu.
2. Use **<UP>** or **<DOWN>** to select **Save**.
3. Press **<ENTER>**.

To cancel parameters for a selected trigger:

1. Select a Trigger from the [Trigger Event](#) menu.
2. Use **<UP>** or **<DOWN>** to select **Cancel**.
3. Press **<ENTER>**.

Stop TR Event

To manually stop the trigger event:

1. Press **<MENU>** repeatedly until **Stop TR Event** shows on the display.
2. Press **<ENTER>**.
3. Use **<UP>** or **<DOWN>** to select the a trigger from **Trigger 1, Trigger 2, Trigger 3, or Trigger 4**.
4. Press **<ENTER>**.
5. Use **<UP>** or **<DOWN>** to select the a trigger from **Stop** (when trigger 1–4 is playing).
6. Press **<ENTER>**.

Enter Mass Storage

To enter mass storage via PC:

1. Press **<MENU>** repeatedly until **Enter Mass Storage** shows on the display.
2. Press **<ENTER>**.
3. Use **<UP>** or **<DOWN>** to select **Connect to PC**.
4. Press **<ENTER>**.

To format the DMX-RT4 SD card:

1. Press **<MENU>** repeatedly until **Enter Mass Storage** shows on the display.
2. Press **<ENTER>**.
3. Use **<UP>** or **<DOWN>** to select **Format SD Card**.
4. Press **<ENTER>**.
5. Use **<UP>** or **<DOWN>** to select **Continue** (to format SD Card) or **Return** (to return to the previous menu).
6. Press **<ENTER>**.

Lock Device

To set a PIN to unlock the DMX-RT4:

1. Press **<MENU>** repeatedly until **Lock Device** shows on the display.
2. Press **<ENTER>**.
3. Use **<UP>** or **<DOWN>** to select **PIN**.
4. Press **<ENTER>**.
5. Use **<UP>** or **<DOWN>** to enter a PIN code, from **000–999**.
6. Press **<ENTER>**.

To disable the device's lock or set the lock to a 30 sec timer:

1. Press **<MENU>** repeatedly until **Lock Device** shows on the display.
2. Press **<ENTER>**.
3. Use **<UP>** or **<DOWN>** to select **Lock**.
4. Press **<ENTER>**.
5. Use **<UP>** or **<DOWN>** to select or **Disable** (disables the lock) or **Timeout** (sets the lock to a 30 sec timer).
6. Press **<ENTER>**.

To unlock the device:

1. Press **<MENU>** repeatedly until **Lock Device** shows on the display.
2. Press **<ENTER>**.
3. Use **<UP>** or **<DOWN>** to select **Manual lock**.
4. Press **<ENTER>**.
5. Press **<MENU>**.
6. Use **<UP>** or **<DOWN>** to select **PIN**.
7. Press **<ENTER>**.
8. Use **<UP>** or **<DOWN>** to enter a PIN code, from **000–999**.
9. Press **<ENTER>**.



- If the PIN code entered is incorrect, a “PIN Error” warning will appear on the display.
- If the user forgets the preset manual lock PIN, the master unlock PIN is 996.

10. Use **<UP>** or **<DOWN>** to select **Unlock**.
11. Press **<ENTER>**.

Device Settings

To access the Device settings menu on the DMX-RT4:

1. Press **<MENU>** repeatedly until **Device Settings** shows on the display.
2. Press **<ENTER>**.
3. Use **<UP>** or **<DOWN>** to select **Device Label**, **DMX Trigger Option**, **Display Option**, or **Version**.
4. Press **<ENTER>**.

To set the device label on the timeout screen of the DMX-RT4:

1. Navigate to the [Device Settings](#) menu
2. Use **<UP>** or **<DOWN>** to select **Device Label**.
3. Press **<ENTER>**.
4. Use **<UP>** or **<DOWN>** to select _____ (Set device label on timeout screen), **Cancel** (returns to previous screen), or **Enter** (press to save once desired label is selected).

To allow the DMX signal to trigger four scenes:

1. Navigate to the [Device Settings](#) menu.
2. Use **<UP>** or **<DOWN>** to select **DMX Trigger Option**.
3. Press **<ENTER>**.
4. Use **<UP>** or **<DOWN>** to select **Trigger**.
5. Press **<ENTER>**.
6. Use **<UP>** or **<DOWN>** to select **ENABLE** (allows DMX signal to trigger scenes) or **DISABLE** (prevents DMX signal from triggering scenes).
7. Press **<ENTER>**.

To set the address for the DMX trigger:

1. Navigate to the [Device Settings](#) menu.
2. Use **<UP>** or **<DOWN>** to select **DMX Trigger Option**.
3. Press **<ENTER>**.
4. Use **<UP>** or **<DOWN>** to select **DMX Address**.
5. Press **<ENTER>**.
6. Use **<UP>** or **<DOWN>** to select an address, from **001–512**.
7. Press **<ENTER>**.

To enable or disable the inverted display:

1. Navigate to the [Device Settings](#) menu.
2. Use **<UP>** or **<DOWN>** to select **Display Option**.
3. Press **<ENTER>**.
4. Use **<UP>** or **<DOWN>** to select **Mode**.
5. Press **<ENTER>**.
6. Use **<UP>** or **<DOWN>** to select **Normal** (enables normal display) or **Inverse** (inverse display).

To enable or disable the timer for the display blackout:

1. Navigate to the [Device Settings](#) menu.
2. Use **<UP>** or **<DOWN>** to select **Display Option**.
3. Press **<ENTER>**.
4. Use **<UP>** or **<DOWN>** to select **Backlight**.
5. Press **<ENTER>**.
6. Use **<UP>** or **<DOWN>** to select **On** (enable backlight) or **0, 05, 10, 15, 20, 25, 30, 35, 40, 45, 50, 55, or 60** (enable backlight timer).
7. Press **<ENTER>**.

To display the DMX-RT4 software version:

1. Navigate to the [Device Settings](#) menu.
2. Use **<UP>** or **<DOWN>** to select **Version**.
3. Press **<ENTER>**.

Operation

Save Configuration

To set the name for the current device configuration:

1. Press **<MENU>** repeatedly until **Save Configuration** shows on the display.
2. Press **<ENTER>**.
3. Use **<UP>** or **<DOWN>** to select **Name**.
4. Press **<ENTER>**.
5. Use **<UP>** or **<DOWN>** to select _____ (to select a name), **Cancel** to (return to previous menu), or **Enter** (to save once a name has been selected).
6. Press **<ENTER>**.

To save the current configuration:

1. Press **<MENU>** repeatedly until **Save Configuration** shows on the display.
2. Press **<ENTER>**.
3. Use **<UP>** or **<DOWN>** to select **Backup Data**.
4. Press **<ENTER>**.
5. Press **Return** upon successful backup.

Load Configuration

To select and load a configuration.

1. Press **<MENU>** repeatedly until **Load Configuration** shows on the display.
2. Press **<ENTER>**.
3. Use **<UP>** or **<DOWN>** to select the desired configuration.
4. Press **<ENTER>**.
5. Use **<UP>** or **<DOWN>** to select **Restore** or **Del**.
6. Press **<ENTER>**.

Default Setting

To restore all settings on the DMX-RT4 tool their original default settings:

1. Press **<MENU>** repeatedly until **Default Setting** shows on the display.
2. Press **<ENTER>**.
3. Use **<UP>** or **<DOWN>** to select **Yes** (Restores all default settings) or **No** (to cancel).
4. Press **<ENTER>**.

5. Maintenance

Product Maintenance

Dust build-up reduces light output performance and can cause overheating. This can lead to reduction of the light source's life and/or mechanical wear. To maintain optimum performance and minimize wear, clean all lighting products at least twice a month. However, be aware that usage and environmental conditions could be contributing factors to increase the cleaning frequency.

To clean the product, follow the instructions below:

1. Unplug the product from power.
2. Wait until the product is at room temperature.
3. Use a vacuum (or dry compressed air) and a soft brush to remove dust collected on the external surface/vents.
4. Clean all transparent surfaces with a mild soap solution, ammonia-free glass cleaner, or isopropyl alcohol.
5. Apply the solution directly to a soft, lint free cotton cloth or a lens cleaning tissue.
6. Softly drag any dirt or grime to the outside of the transparent surface.
7. Gently polish the transparent surfaces until they are free of haze and lint.

6. Technical Specifications

Dimensions and Weight

Length	Width	Height	Weight
4.8 in (122 mm)	3.2 in (81 mm)	1.5 in (38 mm)	0.4 lb (0.2 kg)

Note: Dimensions in inches are rounded.

Power

Power Supply Type	Range	Voltage Selection	DC Input
Switching (external multi-charger)	100 to 240 VAC, 50/60 Hz	Auto-ranging	12 VDC

Parameter	120 V, 60 Hz	230 V, 50 Hz
Consumption	1 W	1 W
Operating Current	0.03 A	0.03 A

	U.S./Worldwide	UK/Europe
Power cable plug	Edison (U.S.)	Local Plug

Memory

Onboard
32 GB

Audio

MP3	WAV
32-320 kps	8 or 16bit

Thermal

Maximum External Temperature	Cooling System
104 °F (40 °C)	Convection

DMX

I/O Connector
3-pin XLR

Ordering

Product Name	Item Code	UPC Number
DMX-RT4	09082001	781462223496



Contact Us

General Information	Technical Support
Chauvet World Headquarters	
Address: 3360 Davie Rd., Suite 509 Davie, FL 33314 Voice: (954) 577-4455 Fax: (954) 929-5560 Toll Free: (800) 762-1084	Voice: (844) 393-7575 Fax: (954) 756-8015 Email: chauvetcs@chauvetlighting.com Website: www.chauvetdj.com
Chauvet U.K.	
Address: Pod 1 EVO Park Little Oak Drive, Sherwood Park Nottinghamshire, NG15 0EB UK Voice: +44 (0) 1773 511115 Fax: +44 (0) 1773 511110	Email: UKtech@chauvetlighting.eu Website: www.chauvetdj.eu
Chauvet Benelux	
Address: Stokstraat 18 9770 Kruishoutem Belgium Voice: +32 9 388 93 97	Email: BNLtech@chauvetlighting.eu Website: www.chauvetdj.eu
Chauvet France	
Address: 3, Rue Ampère 91380 Chilly-Mazarin France Voice: +33 1 78 85 33 59	Email: FRtech@chauvetlighting.fr Website: www.chauvetdj.eu
Chauvet Germany	
Address: Bruno-Bürgel-Str. 11 28759 Bremen Germany Voice: +49 421 62 60 20	Email: DEtech@chauvetlighting.de Website: www.chauvetdj.eu
Chauvet Mexico	
Address: Av. de las Partidas 34 - 3B (Entrance by Calle 2) Zona Industrial Lerma Lerma, Edo. de México, CP 52000 Voice: +52 (728) 690-2010	Email: servicio@chauvet.com.mx Website: www.chauvetdj.mx

Warranty & Returns

For warranty terms and conditions and return information, please visit our website.

For customers in the United States and Mexico: www.chauvetlighting.com/warranty-registration.

For customers in the United Kingdom, Republic of Ireland, Belgium, the Netherlands, Luxembourg, France, and Germany: www.chauvetlighting.eu/warranty-registration.