

# ▶ HMXL42ARC-KIT

## User Manual

## Thank you for purchasing this product.

For optimum performance and safety, please read these instructions carefully before connecting, operating or adjusting this product. Please keep this manual for future reference.



### Surge Protection Device Recommended

This product contains sensitive electrical components that may be damaged by electrical spikes, surges, electric shock, lightning strikes, etc. Use of surge protection systems is highly recommended in order to protect and extend the life of your equipment.

## Contents

Introduction	03
Features	03
Front Panel Description	04
Rear Panel Description	04
EDID Management	05
Front Panel Menu System	06
HDBaseT™ Receiver Compatibility	06
Power Over Cable	06
Terminating CAT Cables for use with HDBT	07
Understanding the HDBaseT™ Status LED's	07
Infrared (IR) Control	08
CEC Control	08
Audio Return Channel	08
Web GUI Control	08-16
Remote Control Description	17
IR Commands	17-18
Specifications	19
Package Contents	19
Maintenance	19
RS-232 Config & Telnet Commands	20-22
Web-GUI Firmware Update	23-24
Schematic	25
Certifications	26

# Introduction

Our Essential 4x2 HDBaseT™ Matrix offers unprecedented performance and value for the custom installation market. The HMXL42ARC-KIT is a HDMI2.0 4K60Hz 4:4:4 HDCP2.2 Matrix package utilising CSC technology to deliver HDMI, Bi-directional IR and PoC up to lengths of 70m over a single CAT cable.

The Matrix also provides advanced features including simultaneous HDBaseT™/HDMI on output 1, video Smart Scaling on HDBaseT™ outputs, manual or auto source selection, Independent Audio Matrix and a web browser interface module for control and configuration of the Matrix. The HMXL42CS-KIT is supplied with 2 x RX70CS HDBaseT™ receivers.

---

## FEATURES:

---

- Advanced HDBaseT™ technology offering distribution of video and audio over a single CAT cable
- Advanced Colour Space Conversion (CSC) supports HDMI 2.0 18Gbps specification including HDR\*
- Features 4 x HDMI inputs which can be independently routed to 2 x HDBaseT™ outputs
- Output 1 features simultaneous HDMI and HDBaseT™ output
- Video Smart Scaling on HDBaseT™ outputs allowing a display only capable of supporting lower video resolutions (4K 60Hz 4:2:0 or 1080p) to receive 4K 60Hz 4:4:4 video content while still showing maximum original 4K UHD resolution on remaining video outputs
- Supports 4K 60Hz 4:4:4 UHD video up to 40m, and 1080p video up to 70m
- 8x2 Audio Matrix independently controllable from video. Audio source inputs include:
  - 4 x audio breakout from HDMI source inputs
  - 2 x audio breakout from zone outputs
  - 2 x ARC from zone outputs
- Supports all known HDMI audio formats including Dolby TrueHD, Dolby Atmos, Dolby Digital Plus and DTS-HD Master Audio transmission
- Web interface module for control and configuration of Matrix
- Supports bi-directional IR and RS-232 on all HDBaseT™ outputs
- Control via front panel, IR, iOS / Android App, RS-232 and TCP/IP
- Supports PoC (Power over Cable) to power compatible HDBaseT™ receivers
- Advanced EDID management and HDCP 2.2 compliant
- Supplied with 2 x RX70CS HDBaseT™ Receivers\*
- Supplied with Blustream IR receivers and emitters

\* PoC, CSC & ARC features compatible with RX70CS only

# Front Panel Description

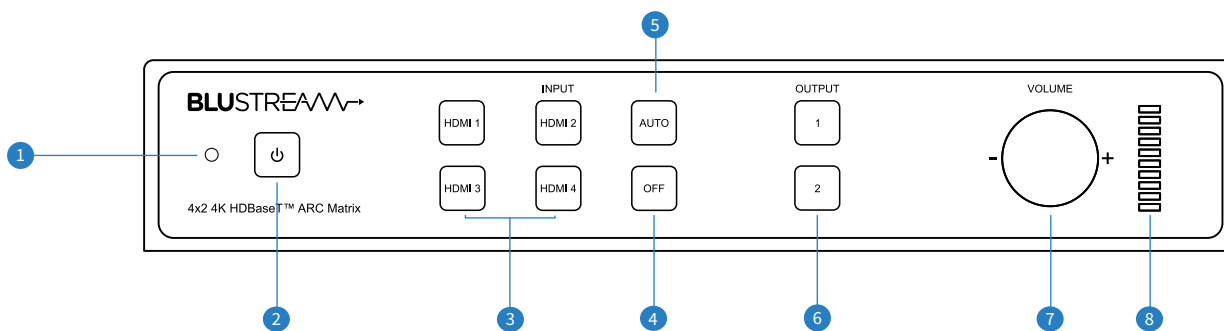

- 1 Power LED status - illuminates blue when the Matrix is powered on, orange when the unit is in standby
- 2 Power Button – press and hold for 3 seconds to power on / off the Matrix
- 3 Input Select - pressing the input button highlights the selected outputs, select an output first and then an input to change the output to selected input
- 4 Off Button - press to enable or disable the video output (must select an output first)
- 5 Auto Select - press and hold to toggle auto source switching on/off (must select an output first)
- 6 Output Select - select output first, then select desired input source to switch the output
- 7 Analogue Audio Line Level Volume Control - rotate to adjust (must select an output first)
- 8 Line Level Volume Control Indicator - displays the current volume level of the selected output

To factory reset the HMXL42ARC from the front panel, press and hold ‘HDMI 1’ and ‘Output 2’ buttons simultaneously for 10 seconds.

# Rear Panel Description

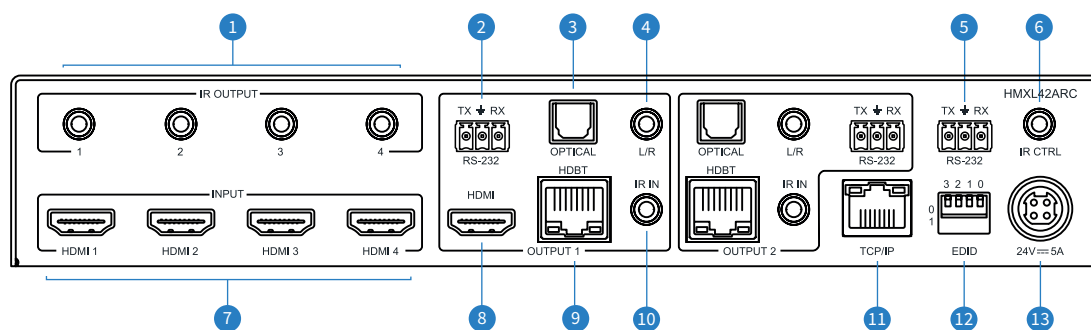

- 1 IR Outputs - 3.5mm mono connector to connect to Blustream 5V IR emitter. Used for local source control
- 2 Bi-directional RS-232 port - connect to third party control device to extend RS-232 commands to HDBaseT™ receivers RS-232 port
- 3 Optical (Toslink) Audio Output - independent audio Matrix. For connection to 3rd party audio device
- 4 Analogue Audio Output - 3.5mm L/R stereo jack - independent audio Matrix. For connection to 3rd party audio devices. **NOTE:** supports 2ch PCM only
- 5 RS-232 - Phoenix connector for RS-232 control of the Matrix
- 6 IR Control Input - 3.5mm stereo connector to connect to Blustream IR receiver for IR control of the Matrix
- 7 HDMI Inputs - connect to source devices
- 8 HDMI Output - Connect to local display device
- 9 HDBaseT™ Output - RJ45 HDBaseT™ port to connect to the HDBaseT™ input port of the supplied RX70CS Blustream HDBaseT™ receiver
- 10 IR Input - 3.5mm stereo connector to connect to 3rd party controller for IR control of equipment connected to the RX70CS HDBaseT™ Receiver
- 11 TCP/IP - RJ45 connector for TCP/IP and web-GUI control of the Matrix
- 12 EDID DIP switch – used for global EDID settings
- 13 4-pin DIN Power Socket - use supplied 24V/4A power supply

# EDID Control

EDID (Extended Display Identification Data) is a data structure that is used between a display and a source. This data is used by the source to find out what audio and video resolutions are supported by the display. By pre-determining the video resolution and audio format of the source and display device you can reduce the time needed for EDID hand shaking thus making switching quicker and more reliable.

Configuration of Matrix EDID settings can be achieved in one of three ways:

- 1 Using Matrix web browser interface (see section on Web-GUI Control)
- 2 Using API commands via RS-232 or Telnet (see below)
- 3 Using Matrix EDID dipperswitches (see below)

### To configure the EDID via RS-232/Telnet API:

Configuration of the EDID settings for each input can be achieved using the following API commands to specify the required EDID. Please see the section on RS-232 and Telnet API at the end of this manual for connectivity information:

```
EDID xx DF zz Set Input xx EDID To Default EDID zz
xx = Input On Product (00 Refers To ALL Inputs, 02 = Input 2 Etc)
zz = 00 : HDMI 1080p@60Hz, Audio 2CH PCM (Default)
01 : HDMI 1080p@60Hz, Audio 5.1CH DTS/DOLBY
02 : HDMI 1080p@60Hz, Audio 7.1CH DTS/DOLBY/HD
03 : HDMI 1080i@60Hz, Audio 2CH PCM
04 : HDMI 1080i@60Hz, Audio 5.1CH DTS/DOLBY
05 : HDMI 1080i@60Hz, Audio 7.1CH DTS/DOLBY/HD
06 : HDMI 1080p@60Hz/3D, Audio 2CH PCM
07 : HDMI 1080p@60Hz/3D, Audio 5.1CH DTS/DOLBY
08 : HDMI 1080p@60Hz/3D, Audio 7.1CH DTS/DOLBY/HD
09 : HDMI 4K@30Hz 4:4:4, Audio 2CH PCM
10 : HDMI 4K@30Hz 4:4:4, Audio 5.1CH DTS/DOLBY
11 : HDMI 4K@30Hz 4:4:4, Audio 7.1CH DTS/DOLBY/HD
12 : HDMI 4K@60Hz 4:2:0/4K@30Hz 4:4:4, Audio 2CH PCM
13 : HDMI 4K@60Hz 4:2:0/4K@30Hz 4:4:4, Audio 5.1CH DTS/DOLBY
14 : HDMI 4K@60Hz 4:2:0/4K@30Hz 4:4:4, Audio 7.1CH DTS/DOLBY/HD
15 : HDMI 4K@60Hz 4:4:4, Audio 2CH PCM
16 : HDMI 4K@60Hz 4:4:4, Audio 5.1CH DTS/DOLBY
17 : HDMI 4K@60Hz 4:4:4, Audio 7.1CH DTS/DOLBY/HD
18 : DVI 1280x1024@60Hz, Audio None
19 : DVI 1920x1080@60Hz, Audio None
20 : DVI 1920x1200@60Hz, Audio None
21 : HDMI 1920x1200@60Hz, Audio 2CH PCM/6CH PCM
22 : User EDID 1
23 : User EDID 2
```

### To configure the EDID via DIP Switch:

To configure the global EDID for all inputs via the DIP switch, use the settings below. Note this will override and disallow any EDID settings configured via the web GUI.

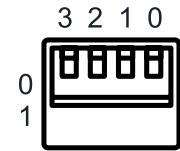

3	2	1	0	EDID Type
Combination of DIP positions				
0	0	0	0	1080p 60Hz 2.0ch
0	0	0	1	1080p 60Hz 5.1ch
0	0	1	0	1080p 60Hz 7.1ch
0	0	1	1	1080i 60Hz 2.0ch
0	1	0	0	1080i 60Hz 5.1ch
0	1	0	1	1080i 60Hz 7.1ch
0	1	1	0	4K 60Hz 4:2:0 2.0ch
0	1	1	1	4K 60Hz 4:2:0 5.1ch
1	0	0	0	4K 60Hz 4:2:0 7.1ch
1	0	0	1	4K 60Hz 4:4:4 2.0ch
1	0	1	0	4K 60Hz 4:4:4 5.1ch
1	0	1	1	4K 60Hz 4:4:4 7.1ch
1	1	0	0	DVI 1280x1024@60Hz
1	1	0	1	DVI 1920x1080@60Hz
1	1	1	0	DVI 1920x1200@60Hz
1	1	1	1	Software EDID

**Please note:** when using the web-GUI of the HMXL42ARC to configure individual EDID settings per input device, the DIP-switches on the rear of the unit must be set to 'Software EDID'.

## HDBaseT™ Receiver Compatibility

This matrix is compatible with all Blusream HDBaseT™ receivers, however support of specific features will vary. It is recommended to utilise the supplied Blustream RX70CS HDBaseT™ receivers with this Matrix as these fully support the following key features:

- CSC - Colour Space Conversion, the method utilised to support 18Gbps signals being transmitted over HDBaseT™
- ARC - Audio Return Channel, to output the displays Audio Return Channel from the optical outputs of the Matrix
- PoC - Power Over Cable, to power the HDBaseT™ receiver from the Matrix over CAT cable without any additional power supplies required

## Power Over Cable

PoC (Power over Cable) is enabled on this product by default as it is specifically designed to be used with the included RX70CS receivers.

If not using the supplied RX70CS receivers, please check the HDBaseT™ receiver supports 24V PoC before connecting to this Matrix to avoid any risk of damaging the device. The Blustream RX70CS HDBaseT™ receiver is recommended for use with this Matrix as it supports all features of this Matrix.

There are 2 ways to enable/disable PoC on this matrix:

- 1 Using Matrix web browser interface (see section on Web GUI operation)
- 2 Using API commands via Telnet / RS-232 (see Telnet API section towards the end of this manual)

## Terminating CAT Cable for use with HDBaseT™

It is important that the interconnecting CAT cable between Blustream HDBaseT™ products is terminated using the correct RJ45 pin configuration. The link CAT cable MUST be a 'straight' (pin-to-pin) CAT cable, and it is advised that this is wired to the T568B wiring standard as this format is less prone to EMI (Electro-Magnetic Interference).

When installing CAT cables it is advised that you use the best possible CAT cable quality. HDMI distribution products will only work if used with CAT5e standard cable or above. Blustream recommends using a CAT6 cable (or better) for installations, especially when running longer distances, in areas of high EMI, or for 4K signal distribution. It is advised that using any method of patch panel, wall plate, or join within the CAT cable is avoided as these can add degradation to the signal. Blustream also recommend using RJ45 connectors that are recommended for use with the choice of CAT cable.

### RJ45 Wiring - T568B

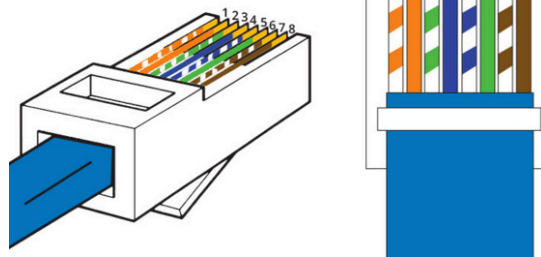

## Understanding the HDBaseT™ Status LED's

The matrix includes status LED indicators on the HDBaseT™ RJ45 ports to show all connections are active, and to help diagnose potential connectivity issues.

### Understanding the Status Lights:

- The yellow HDBaseT™ status link light will be OFF when there is no HDBaseT™ link established with a Blustream HDBaseT™ receiver
- The yellow HDBaseT™ status link light will be ON when there is a HDBaseT™ link established with a Blustream HDBaseT™ receiver
- The green HDBaseT™ link light will be OFF when there is no video signal being transmitted between the matrix and Blustream HDBaseT™ receiver
- The green HDBaseT™ link light will be ON when there is a HDCP enabled video signal being transmitted between the matrix and Blustream HDBaseT™ receiver
- The green HDBaseT™ link light will BLINK when there is a video signal with no HDCP being transmitted between the matrix and HDBaseT™ receiver

The link lights will only serve as an indication to the connectivity between matrix and HDBaseT™ receiver unit.

The LED's will not indicate a termination, bandwidth, interference or cable length issues on a CAT cable run. Blustream always recommend qualifying / verifying / certifying a CAT cable run for suitability prior to the installation of HDBaseT™ equipment.

## Infrared (IR) Control

The Blustream range of matrix products include Matrix control via IR.

**IMPORTANT: Blustream Infrared products are all 5V and NOT compatible with alternative manufacturers Infrared solutions. When using third party 12V IR control solutions please use the Blustream IRCAB cable for IR conversion.**

### IR Receiver - IRR

Blustream 5V IR receiver to receive an IR signal for control of the matrix.

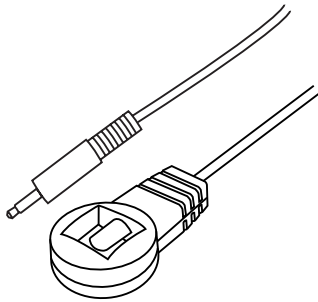

### IR Receiver - Stereo 3.5mm

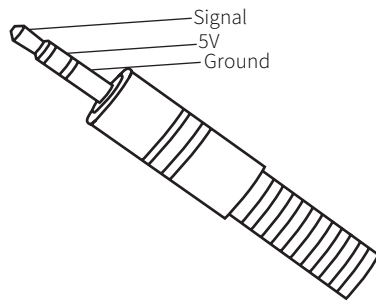

### IR Control Cable - IRCAB

Blustream IR Control cable 3.5mm Mono to 3.5mm Stereo for linking third party control solutions to Blustream products.

Compatible with 12V IR 3rd party products.

**Please Note:** cable is directional as indicated.

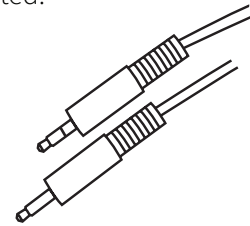

## CEC Control

The Matrix features CEC control of source devices and displays via the products web GUI and RS-232. It is possible to send CEC commands such as power on / off, input selection as well as volume up or down. Please see the Web GUI CEC Control page or RS-232 command list in this document for more information and a full list of CEC commands.

**Please note:** CEC is subject to the support of standardised codes for the sources and displays connected to the Matrix. This matrix does not allow for CEC commands to be passed through from screen to source, or vice-versa.

## Audio Return Channel

This Matrix allows audio from your supported displays Audio Return Channel (ARC) to be sent back to the Matrix via the supplied RX70CS HDBaseT™ receiver either via HDMI ARC or Optical Audio Return. This can be configured on the Audio page within the web-GUI of the Matrix. See page 9 for further details.

## Web-GUI Control

The following pages take you through the operation of this Matrix's Web-GUI. You must connect the TCP/IP RJ45 socket to your local network in order to access the products Web-GUI.

By default the matrix is set to DHCP, however if a DHCP server (eg: network router) is not installed the matrix IP address will revert to below details:

Default IP Address is: **192.168.0.200**

Default Username is: **blustream**

Default Password is: **1234**

The web-GUI supports multiple users along with multiple user permissions as follows:

**Guest Account** - This account does not require a user to login. The Guest account can only change sources for each zone. Guest access can be changed by the Admin, limiting inputs or outputs as necessary.

**User Accounts** - 7x User accounts can be utilised, each with individual login details. User accounts can be assigned permissions to specific areas and functions. A User must log in to make use of these functions.

**Admin Account** - This account allows full access to all functions of the Matrix as well as assigning users with permissions.



### Login Page

The Login Page allows a user or admin to login and access additional functionality. This page also shows you the current firmware version of both the matrix and web-GUI.

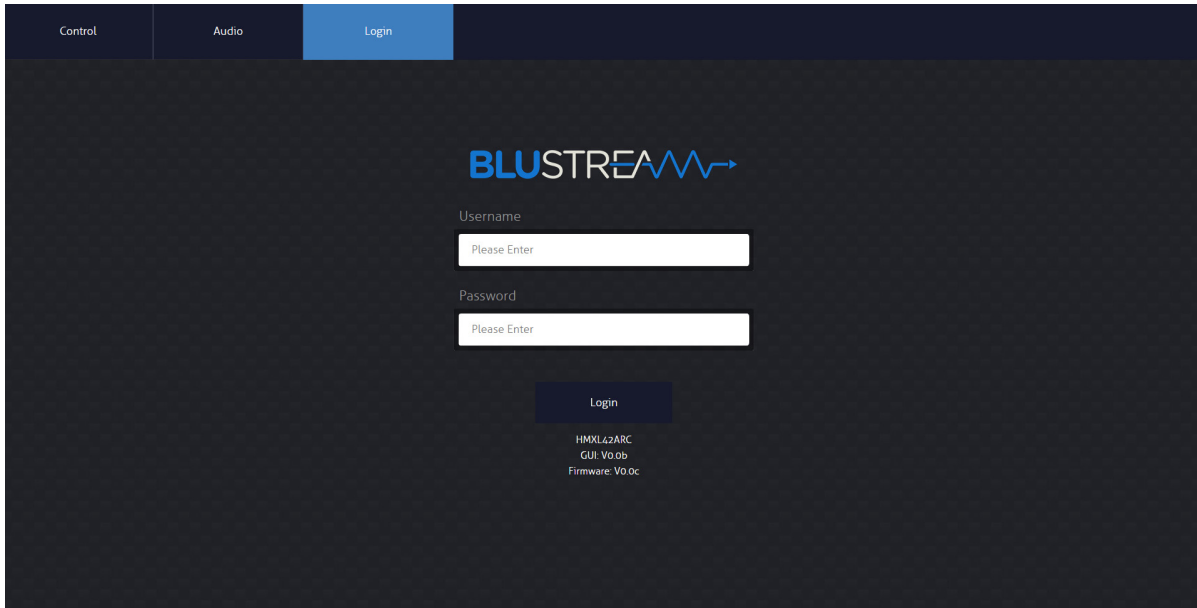

### Guest Control Page

The Guest Control Page allows a guest to change inputs for each zone without needing to be logged into the matrix. Simply select the square that corresponds with the input and zone you wish to change.

There is also a power button on the lower right corner to turn the Matrix on or off.

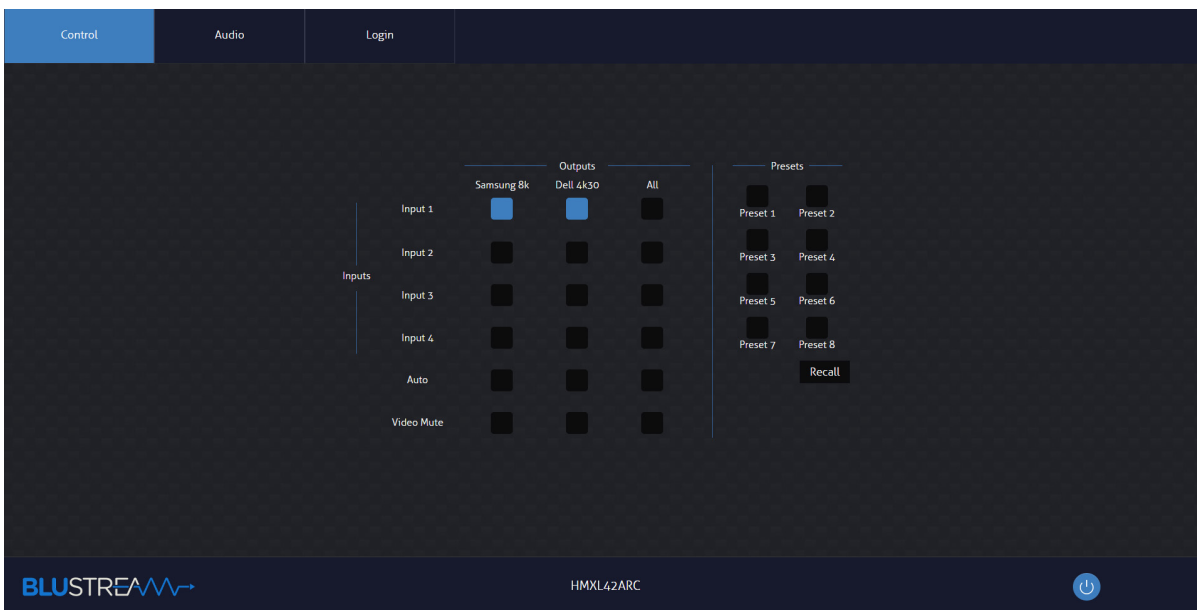

### Audio Control Page

The Audio Control Page allows you to change the source audio of the matrix per output, as well as adjust the line level volume output or enable/disable the muting of the analogue or digital outputs. The Audio Select drop down menu also allows selection of Audio Return Channel either via HDMI or RX from the supplied RX70CS HDBaseT™ receiver.

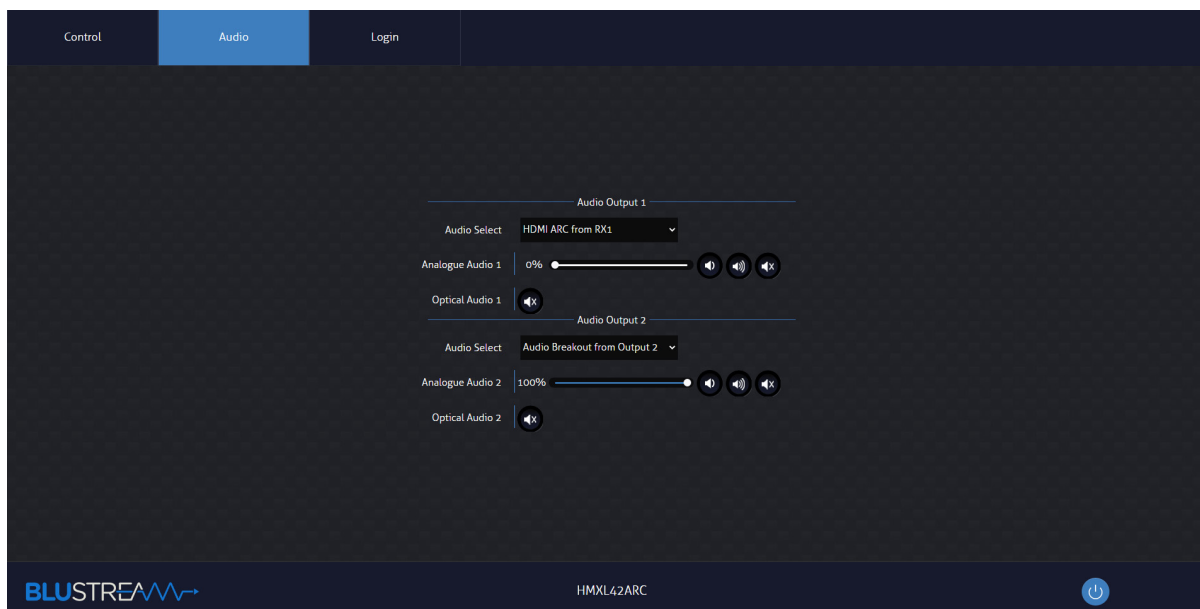

### User Control Page

A logged in User or Admin Control Page allows a user to change inputs and presets for each zone. To change inputs, simply select the square that corresponds with the input and zone output you wish to change. On the right side you can recall a preset, or save the current input/output configuration into a specified preset.

There is also a power button on the lower right corner to turn the Matrix on or off.

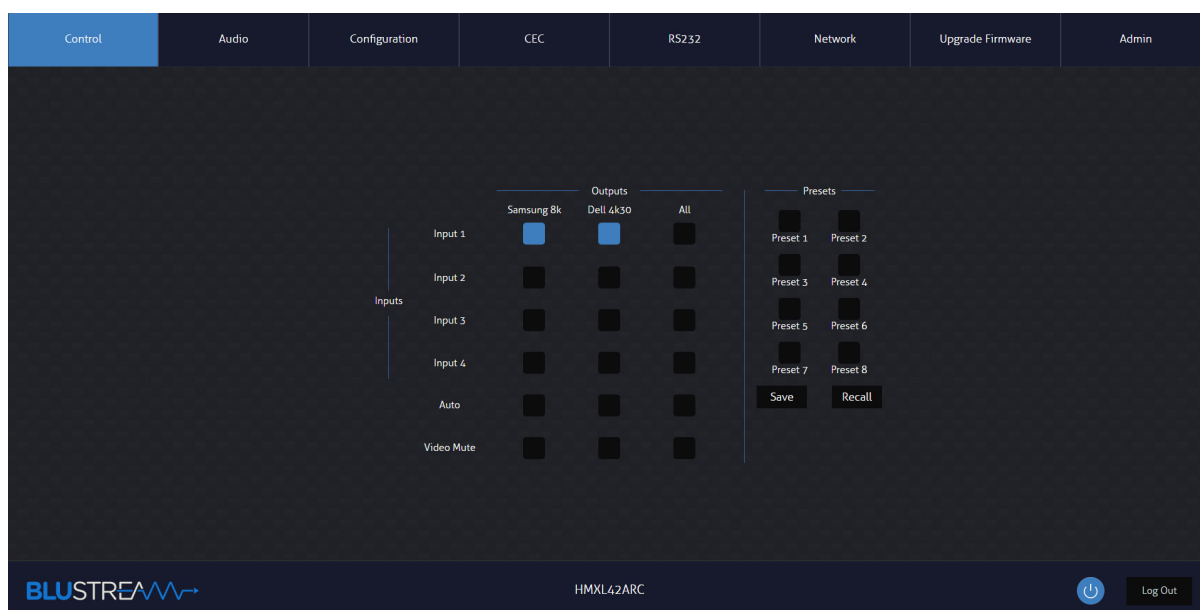

### Configuration IR Select Page

The Configuration IR Select Page allows you to change the IR routing of the matrix. Simply select the square that corresponds with the input and zone output you wish to set up a bi-directional IR relationship with, to have IR route only between that input to output.

By enabling the 'IR Follow Video Switching' setting, IR will no longer have a fixed route. IR from zones will be transmitted to the input corresponding with whichever video input is selected. IR inputs will be transmitted to whatever outputs zones are currently viewing this input source.

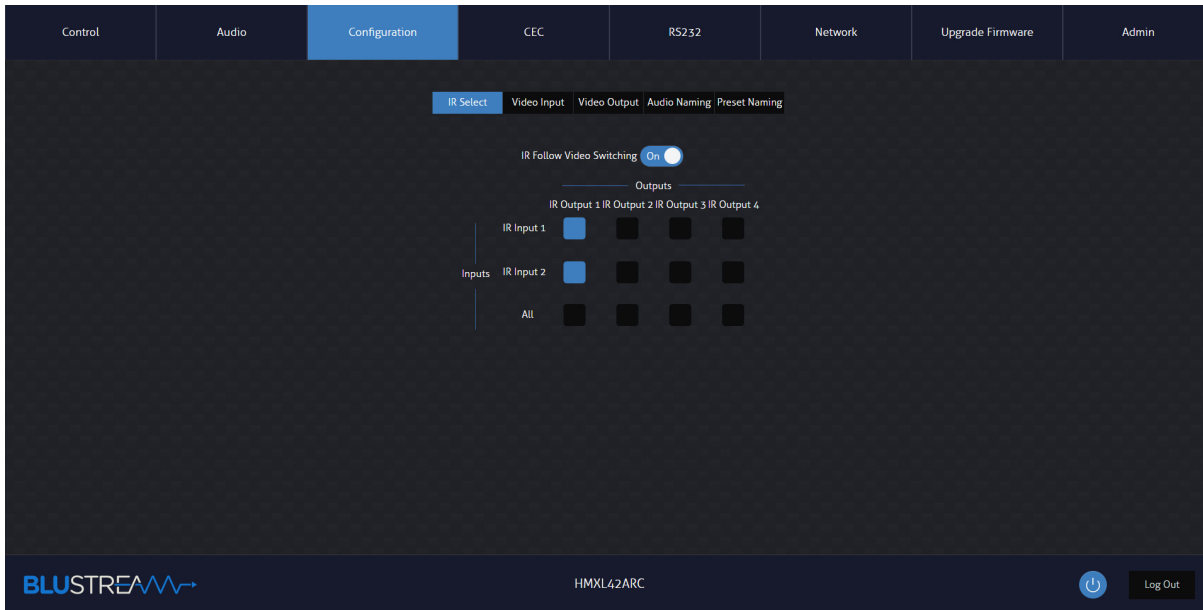

### Configuration Video Input Page

The Configuration Video Input Page allows users to change settings specific to the inputs of the matrix. You can adjust the name of each input, the EDID of each input as well as enable or disable CEC to the input.

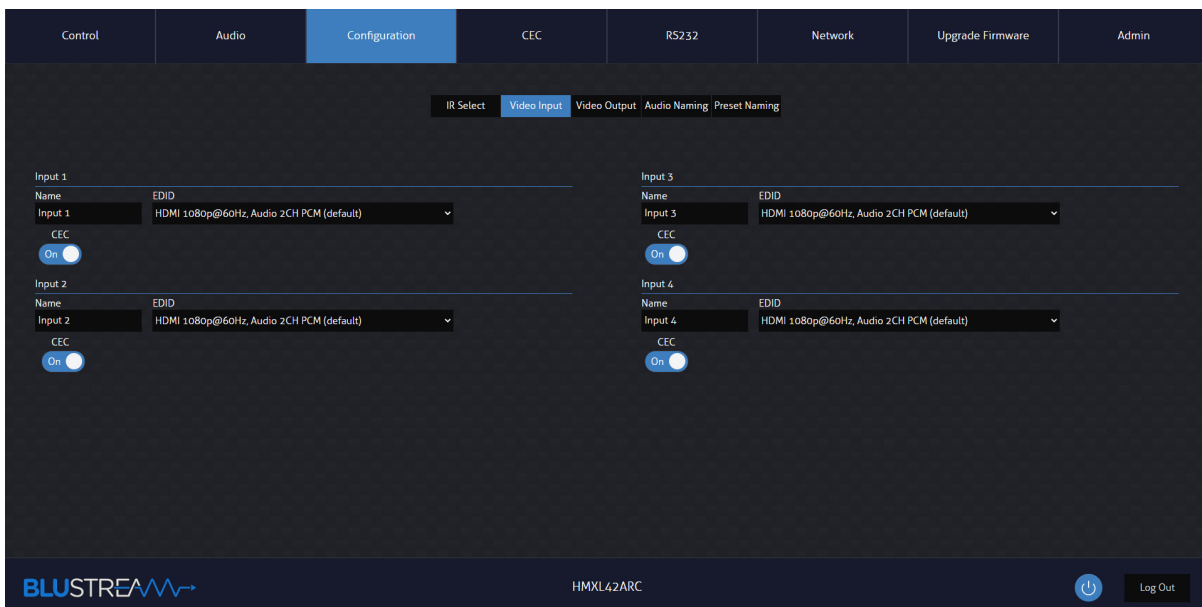

### Configuration Video Output Page

The Configuration Video Output Page allows you to change settings specific to the outputs of the Matrix as follows:

- The name of each output
- Enable or disable CEC to the output
- Enable or disable HDMI Auto Downscale - this will enable/disable automatic conversion from 4K 60Hz 4:4:4 to 4K 60Hz 4:2:0 for displays that do not support 18Gbps HDMI signals. Downscaling will depend on resolutions supported by the display device.
- Enable or disable PoC (Power over Cable) to power the connected HDBT receiver. It is recommended to use the Blustream RX70CS HDBaseT Receiver to support all features of this Matrix
- Enable or disable IR being transmitted out to a zone or from that zone output
- Set EDID Priority (output 1) where you can specify if the HDBT output or HDMI output should have priority for EDID management.

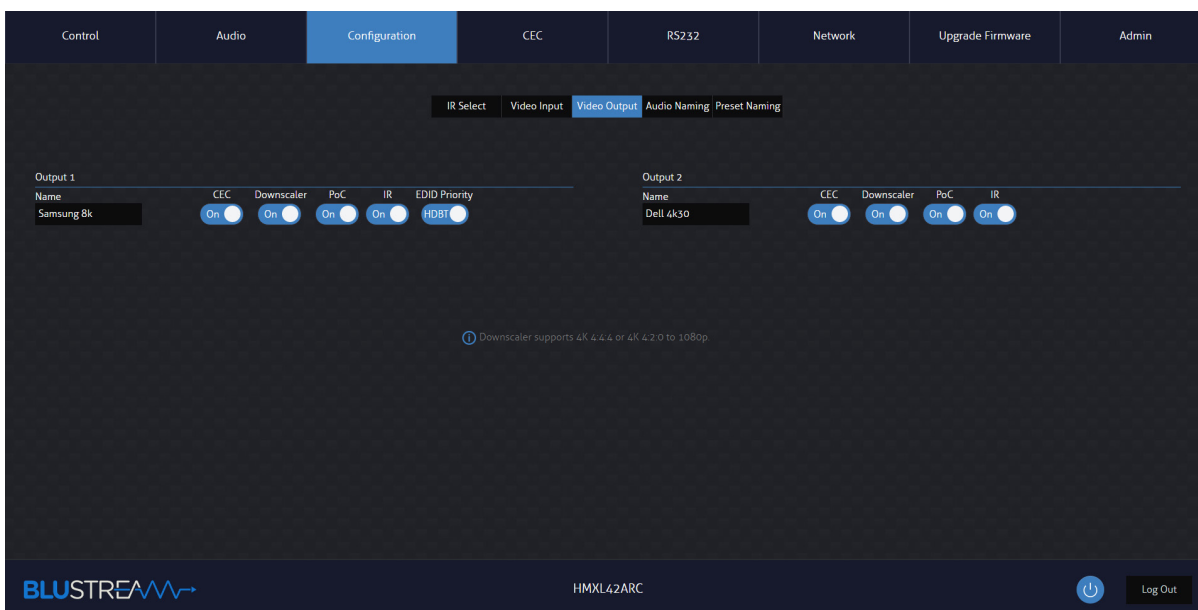

### Configuration Audio Naming Page

The Configuration Audio Naming page allows you to rename all audio inputs and outputs to human readable names, such as the name of your source device, or the name of the zone output (eg: Kitchen, Bedroom, etc...)

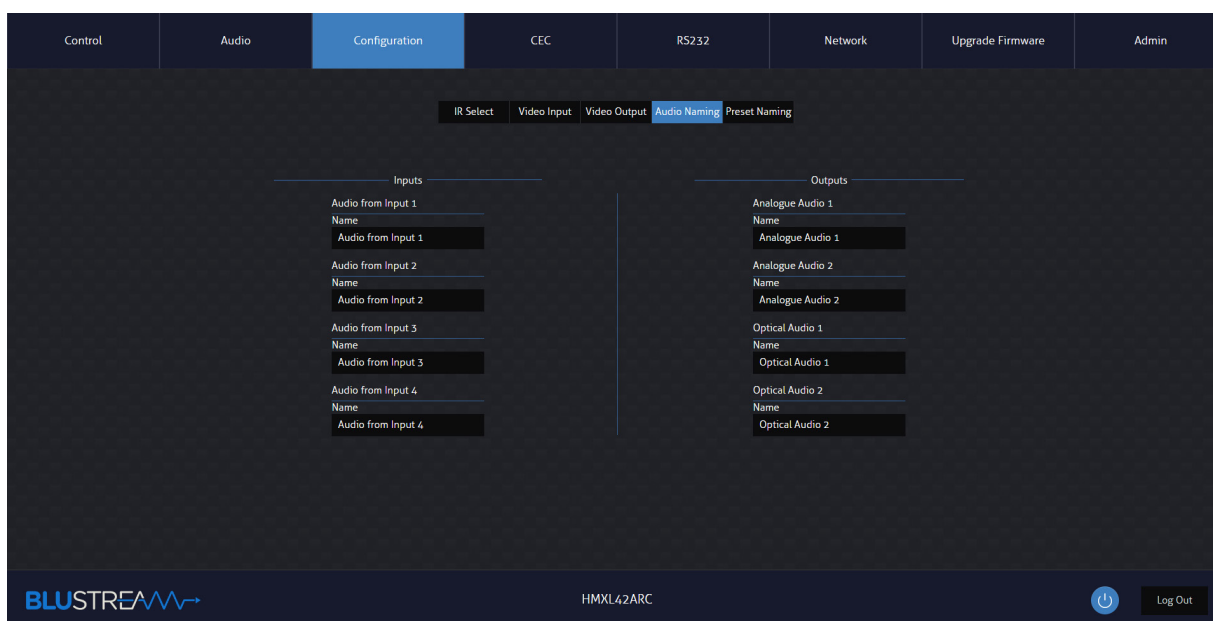

### CEC Page - Input

The CEC Page allows pre-defined CEC commands to be sent to Inputs or Outputs of the Matrix. Choose between Input, Output and User-defined sections at the top of the page. On the CEC Input Page, an input must be specified to send the CEC command to. Press the icon of the command to send which will be transmitted to the source device connected to the specified input via HDMI.

**Please note:** CEC is subject to the support of the sources and displays connected to the Matrix.

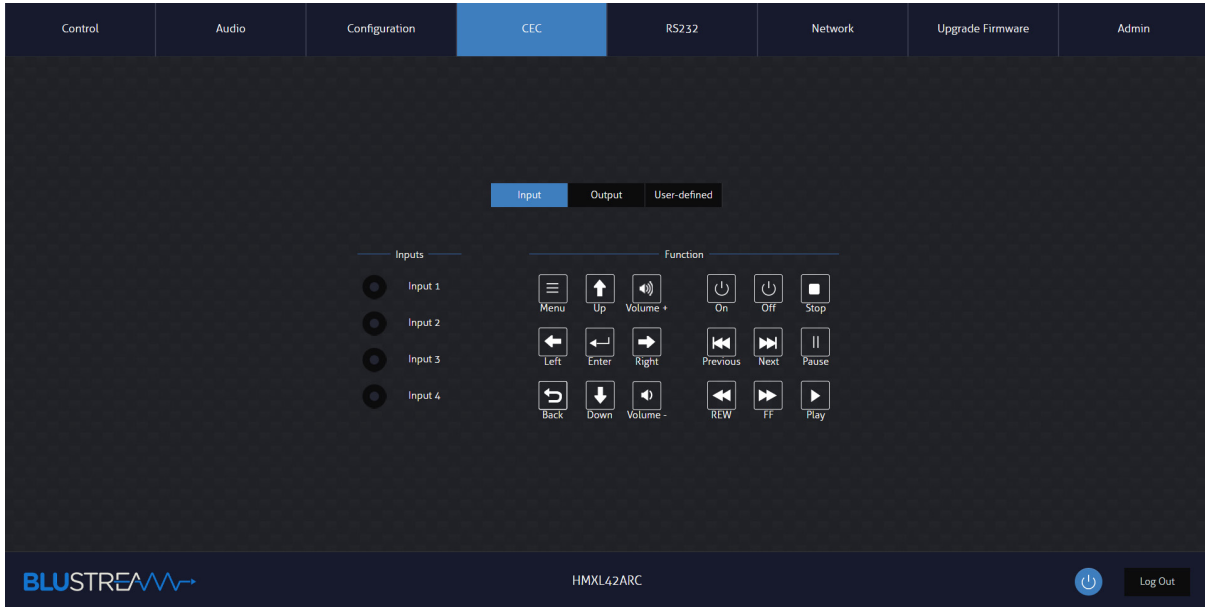

### CEC Page - Output

On the CEC Output Page, specify a specific output to send the CEC command out of. Press the icon of the command to send and it will be transmitted to the display device connected to the specified output.

**Please note:** CEC is subject to the support of the sources and displays connected to the Matrix.

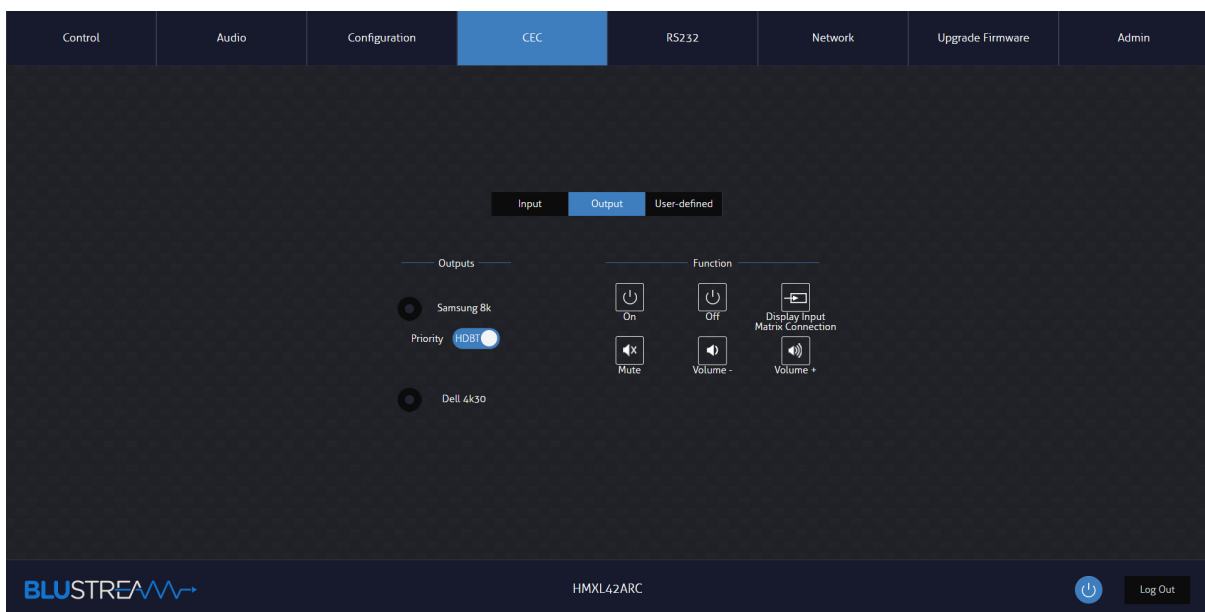

### CEC Page - User-defined

The CEC User-defined Page allows custom CEC commands to be sent to any Output of the Matrix.

Select an output and then enter the custom CEC command to send the desired function to the output display.

**Please note:** CEC is subject to the support of the sources and displays connected to the Matrix.

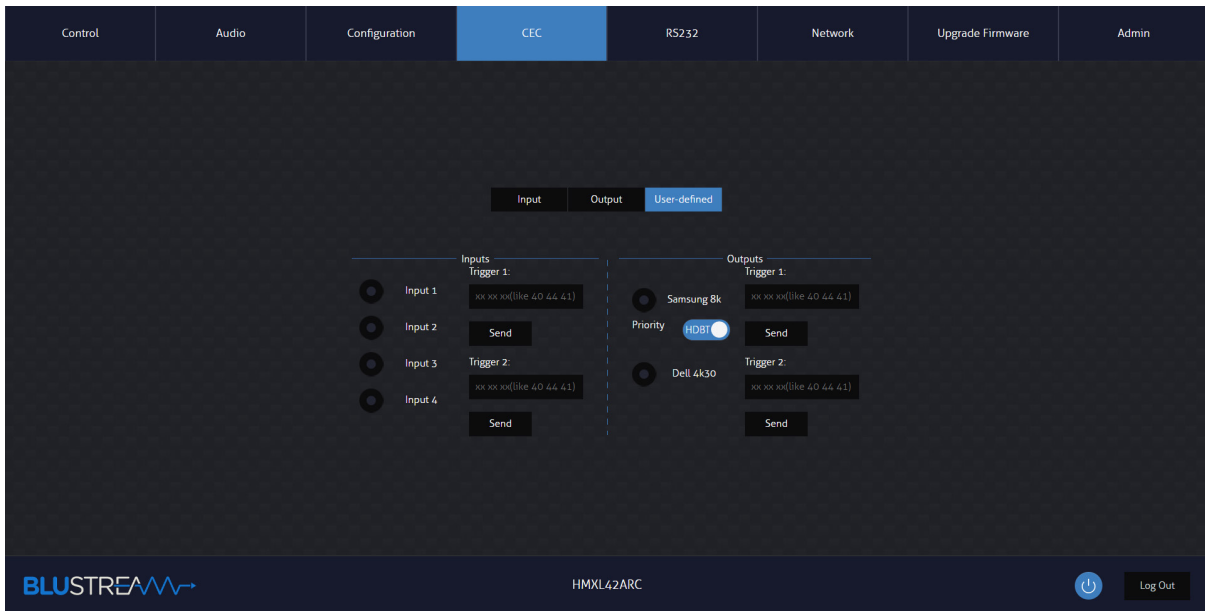

### RS-232 Page - Local

The RS-232 Page allows commands to be sent either out of the local RS-232 port on the Matrix itself, or via HDBT and out of a compatible HDBT Receiver connected to a display. If the Local radio box is selected, RS-232 commands will be sent out of the 3-pin Phoenix serial port at the rear of the matrix to a connected device. Baud rate and terminator command as well as Hex or ASCII can be selected.

Sending an RS-232 command out via the Matrix can be useful in assisting with debugging and fault finding an RS-232 device connected to the matrix.

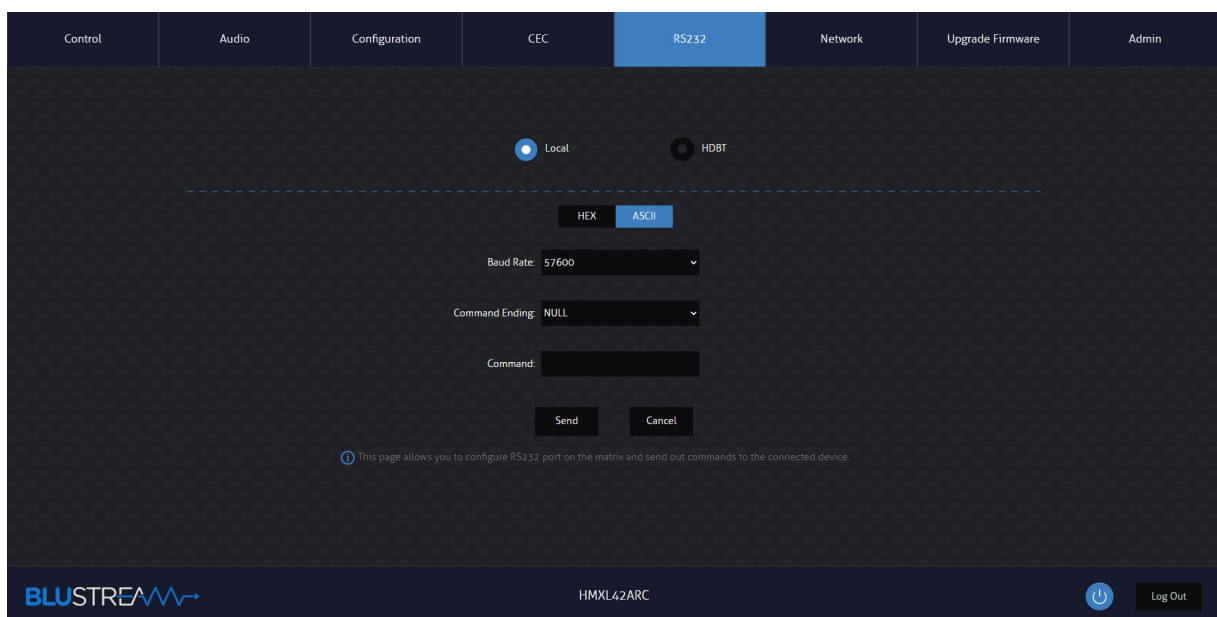

### RS-232 Page - HDBT

The RS-232 HDBT Page can remotely control devices connected via DB9 serial to the remote HDBaseT Receiver. It is then possible to automate the display on, input select and display off process via RS-232 for each HDBaseT output, when the Matrix is turned on or off.

If 'RS-232 On' is enabled, the User Commands 1, 2, 3, 4, and 5 are all sent out of the HDBaseT Receiver, when the Matrix is turned on.

If 'RS-232 Off' is enabled, the User Off Command will be sent out of the corresponding HDBaseT Receiver, when the Matrix is turned off.

It is also possible to specify the Baud Rate and Command Ending (eg: new line, carriage return) to the match the RS-232 device connected to the HDBaseT Receiver.

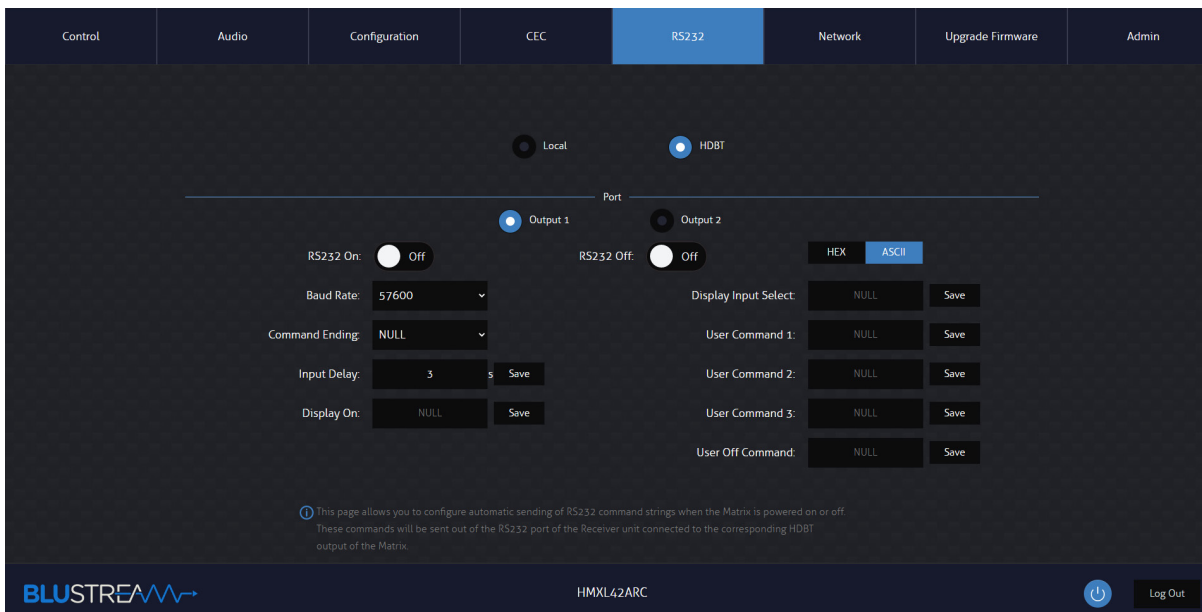

### Network Page

The Network Page allows the TCP/IP network port settings to be specified. Choose from Static IP or DHCP, as well as specify a fixed IP Address, Subnet Mask and Gateway. It is also possible to change or disable the Telnet port.

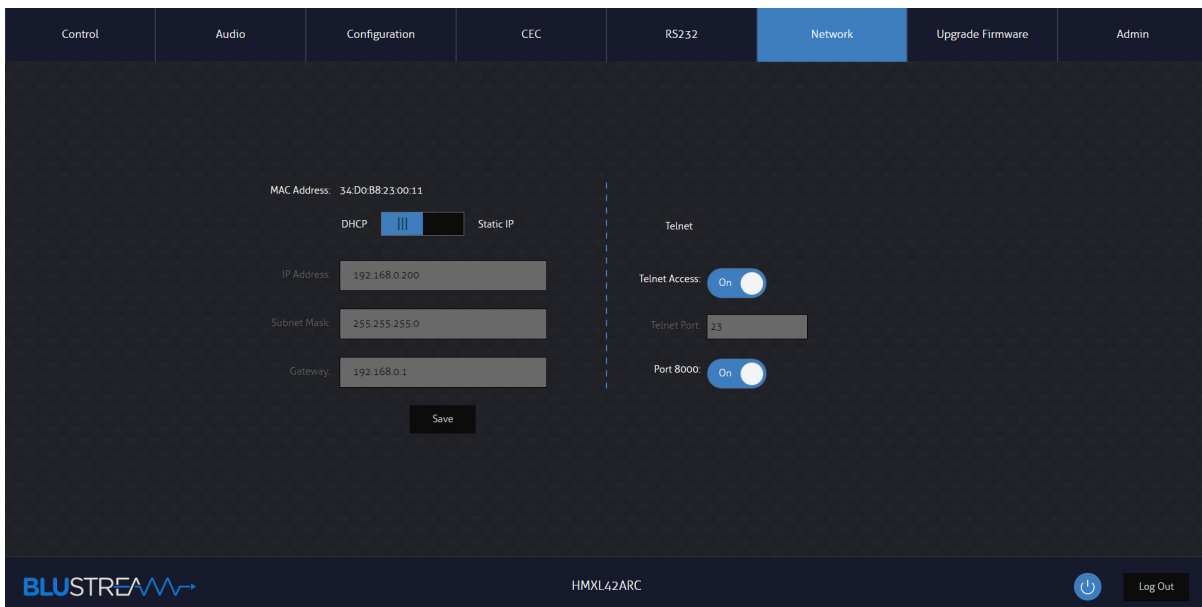

### Upgrade Firmware Page

The Upgrade Firmware Page will show the current firmware version of the Matrix, including the web-GUI version and the MCU firmware version. It also allows you to upgrade the firmware of both the Matrix MCU as well as the Receiver units connected to the Matrix. Simply select whether you are updating the Matrix MCU or a Receiver connected to the unit, browse for the firmware update file, and press Submit. If you have selected to update a Receiver, you will see a pop up window asking you to select a specific Receiver or all Receivers to update.

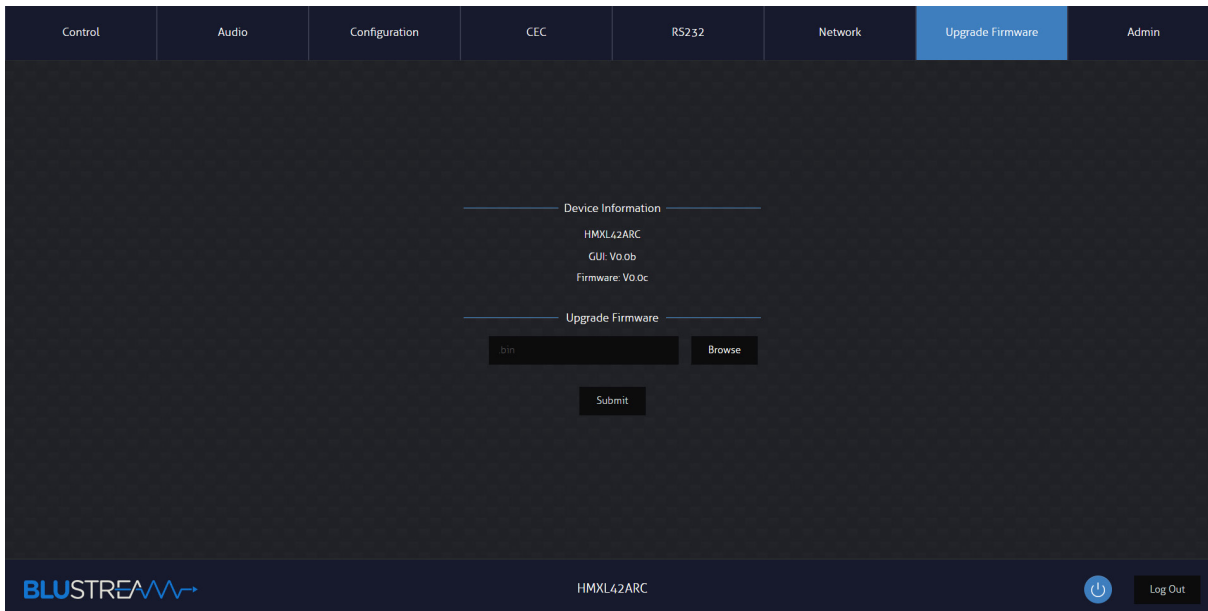

### Admin Page

The Admin Page allows the admin to configure up to 8 users including a guest user. Each user can adjust their password via this page as well.

The Admin, or Users who have been given Admin permissions, are able to allocate permissions to Users. These permissions include allowing or disallowing access to each page in the web-GUI, as well as allowing or disallowing access to each input or output in the Matrix.

The Admin Page also allows you to lock or unlock the Front Panel Buttons or Front Panel IR of the matrix as well as Factory Reset the Matrix.

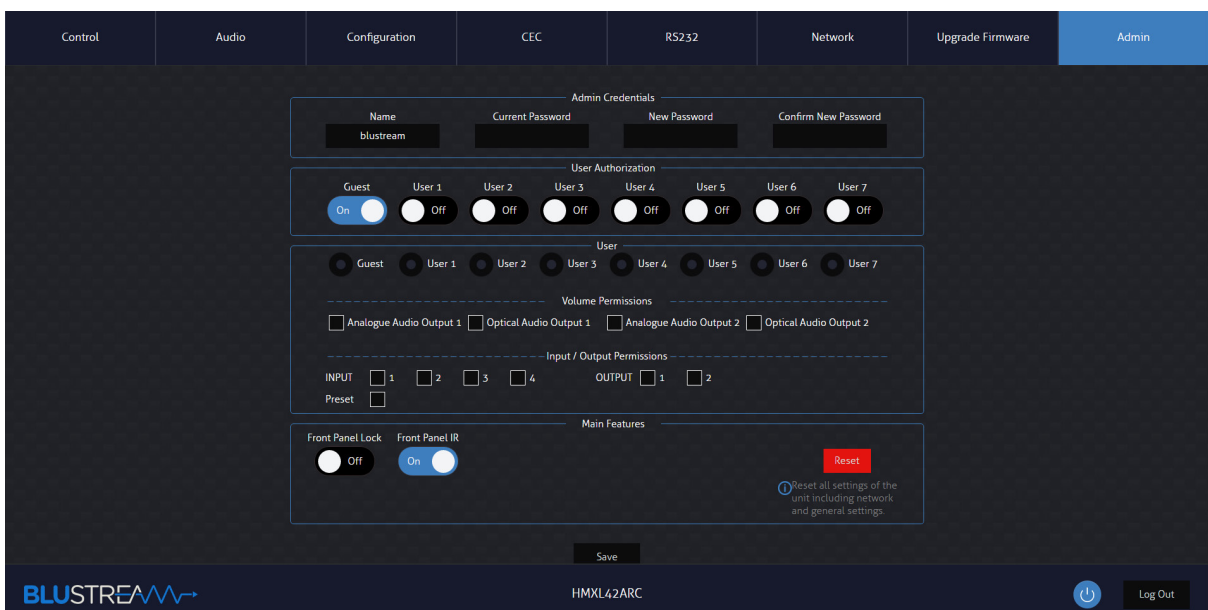



**Please note:**

To enable a User and create password for a user account, complete all 4 text fields under the User section: Name, Current Password, New Password and Confirm New Password.

For all users, the default password is the same as their name (all lower case).

For example: User1 password is user1, User2 password is user2, etc...

To change user2 password to 12345, complete the following steps:

1. Ensure that the User Authorization button is set to On for User 2
2. Select the User 2 radio button
3. Enter Name as User2 (or the user's name)
4. Enter Current Password as user2
5. Enter New password and Confirm New Password as 12345
6. Select the 'Save' button at the bottom

## Remote Control Description

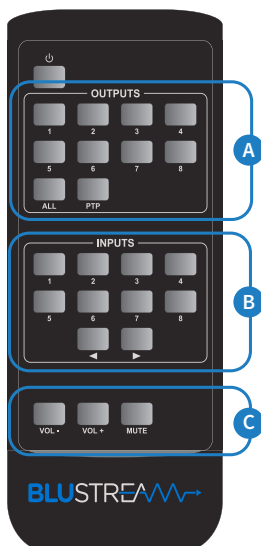

### OUTPUT AND INPUT SELECTION

- A** Select the zone Output you wish to change the source on (Numbers 1-2 correspond to the zone outputs 1-2, or ALL corresponds with all outputs). Pressing the PTP button will mirror all inputs and outputs (Example - Input 1 to output 1, input 2 to output 2 etc).
- B** Select the source Input you wish to change the selected zone to (numbers 1-4 correspond to the source inputs)
- C** You can adjust the volume or mute each of the outputs by pressing the desired output button first, and then pressing the VOL +, VOL - or MUTE button.



## Specifications

- **Video Input Connectors:** 4 x HDMI Type A, 19-pin, female
- **Video Output Connectors:** 1 x HDMI Type A, 19-pin, female, 2 x HDBaseT™ RJ45 connectors
- **Audio Output Connectors:** 2 x Analogue audio L/R (3.5mm stereo Jack), 2 x Optical (S/PDIF)
- **RS-232 Serial Port:** 3 x 3-pin phoenix connector
- **IR Input Ports:** 3 x 3.5mm stereo jack
- **IR Output Ports:** 4 x 3.5mm mono jack
- **Rack Mountable:** 1U rack height, rack ears included
- **Surface Mount Kit:** brackets for surface mounting Matrix
- **Casing Dimensions (W x H x D):** 220mm x 44mm x 235mm (without feet)
- **Shipping Weight:** 4.5kg
- **Operating Temperature:** 32°F to 104°F (-5°C to +55°C)
- **Storage Temperature:** -4°F to 140°F (-25°C to +70°C)
- **Power Supply:** 1 x 24V/5A DC - 4-pin DIN connector

**NOTE:** Specifications are subject to change without notice. Weights and dimensions are approximate.

## Package Contents

- 1 x HMXL42ARC
- 2 x RX70CS HDBaseT Receivers
- 1 x Rack Mounting Kit
- 1 x Surface Mounting Kit
- 1 x IR Remote Control
- 4 x IR Emitters
- 3 x IR Receivers
- 1 x Serial Cable - DB9 to 3-pin Phoenix Connector
- 1 x IR Control Cable - 3.5mm to 3.5mm
- 1 x Quick Reference Guide
- 1 x 24V/5A Power Supply Unit and IEC Power Cables

## Maintenance

Clean this unit with a soft, dry cloth. Never use alcohol, paint thinner or benzene to clean this unit.

## RS-232 Configuration and Telnet Commands

The Blustream Matrix can be controlled via serial and TCP/IP.

The RS-232 port is used for configuration and control of the product, as well as pass through of RS-232 commands to a compatible Blustream HDBaseT™ receiver.

The default RS-232 communication settings are:

Baud rate: 57600

Data bit: 8

Stop bit: 1

Parity bit: none

The following pages list all available serial commands.

### Commonly used Serial Commands

There are several commands that are commonly used for control and testing:

<b>STATUS</b>	Status will give feedback on matrix such as zones on, type of connection etc...
<b>PON</b>	Power on
<b>POFF</b>	Power off
<b>OUTxxON</b>	(xx is the zone number you wish to turn on)
Example:-	OUT01ON (This would turn output one back on)
<b>OUTxxFRyy</b>	(xx is the zone out, yy is the input)
Example:-	OUT01FR04 (This would switch output 1 to source input 4)

### Common Mistakes

- Carriage return – Some programs do not require the carriage return where as other will not work unless sent directly after the string. In the case of some Terminal software the token <CR> is used to execute a carriage return. Depending on the program you are using this token maybe different. Some other examples that other control systems deploy include \r or 0D (in hex)
- Spaces – Blustream commands do not require space between commands unless specified. There may be some programs that require spacing in order to work.
  - How the string should look is as follows OUT01ON
  - How the string may look if spaces are required: OUT{Space}01{Space}ON
- Baud rate or other serial protocol settings not correct

# RS-232 Configuration and Telnet Commands

COMMAND	ACTION
? / HELP	Print help information
STATUS	Print system status and port status
INSTA	Print All Inputs Status
OUTSTA	Print All Outputs Status
CTRLSTA	Print All Controls Status
PRESETSTATUS	Print All Preset Configurations
PON	Power On, system run on normal state
POFF	Power Off, system run on power save state
RESET	Reset System To Default Setting
KEY ON/OFF	Set System Front Panel KEY Control On Or Off
IR ON/OFF	Set System Front Panel IR Control On Or Off
LCD ON/OFF	Set LCD Always On Or Set LCD Off After No Operation 30 Seconds
IROUT xx ON	Enable IR Remote-control Mode On HDBT Output xx
IROUT xx OFF	Disable IR Remote-control Mode On HDBT Output xx
RESET	Reset System To Default Setting (Type "Yes" To Confirm, Or Send Other Command To Discard)
OUT xx EH	Priority Output for EDID Copy and CEC = HDMI
OUT xx ET	Priority Output for EDID Copy and CEC = HDBT xx = [00-01] : Output 1
POCOUT xx ON	Set PoC On On Output xx
POCOUT xx OFF	Set PoC Off On Output xx
SPDIF xx MUTE	Set SPDIF Mute On Output xx
SPDIF xx UNMUTE	Set SPDIF Unmute On Output xx
OUT xx ON	Set Output xx On
OUT xx OFF	Set Output xx Off
OUT xx FR yy	Set Output From Input:yy xx = 00 : All Outputs xx = [01-02] : Output 1 - 2 yy = [01-04] : Input 1 - 4
AUDIO xx FR yy	Set Audio Output xx From Input yy xx = 00 : All Outputs xx = [01-02] : Output 1 - 2 yy = [01-04] : Audio From Input 1-4 yy = [09-10] : Audio From Output 1-2 yy = [17-18] : Audio From ARC 1-2
MXIR xx FR yy	Local Matrix IR Out xx From Remote Rx yy IR In xx = [01-04] : Local IR Out 1 - 4 yy = [01-02] : Remote Rx IR In 1 - 2 yy = [00] : All Remote Rx IR In
MUTE mm TX xx	Turn Mute On/Off On Output xx mm = On mm = Off xx = 00: All Outputs xx = 01 - 02: Analogue Output 1 To 2 xx = 09 - 10: Optical Output 1 To 2
AUDOUT xx mm	Turn Mute On/Off On Output xx mm = On mm = Off xx = 00: All Outputs xx = 01 - 02: Analogue Output 1 To 2 xx = 09 - 10: Optical Output 1 To 2

COMMAND	ACTION
VOL xx TX yy	Set Volume Level xx On Output yy xx = [0...100]: Set Volume Level xx = +: Volume Level Increases xx = -: Volume Level Decreases yy = 00: Select All Output Ports yy = [01...04]: Select Single Output Port 01 To 04
OUT xx ARC aa	Set RX70ARC On Output xx To ARC Mode aa xx = 00 : All Outputs xx = [01-02] : Output 1 - 2 aa = 01 : ARC From SPDIF aa = 02 : ARC From HDMI
OUT xx SCALING ON/OFF	Set Output xx Scaling ON/OFF xx = 00 : All Outputs xx = [01-02] : Output 1 - 2
IRFV ON/OFF	Local Matrix IR Out Follow Video Switching ON/OFF
EDID xx DF zz	Set Input xx EDID To Default EDID zz xx = Input On (00 Refers To ALL Inputs, 02 = Input 2 Etc) zz = 00 : HDMI 1080p@60Hz, Audio 2CH PCM (Default) 01 : HDMI 1080p@60Hz, Audio 5.1CH DTS/DOLBY 02 : HDMI 1080p@60Hz, Audio 7.1CH DTS/DOLBY/HD 03 : HDMI 1080i@60Hz, Audio 2CH PCM 04 : HDMI 1080i@60Hz, Audio 5.1CH DTS/DOLBY 05 : HDMI 1080i@60Hz, Audio 7.1CH DTS/DOLBY/HD 06 : HDMI 1080p@60Hz/3D, Audio 2CH PCM 07 : HDMI 1080p@60Hz/3D, Audio 5.1CH DTS/DOLBY 08 : HDMI 1080p@60Hz/3D, Audio 7.1CH DTS/DOLBY/HD 09 : HDMI 4K@30Hz 4:4:4, Audio 2CH PCM 10 : HDMI 4K@30Hz 4:4:4, Audio 5.1CH DTS/DOLBY 11 : HDMI 4K@30Hz 4:4:4, Audio 7.1CH DTS/DOLBY/HD 12 : HDMI 4K@60Hz 4:2:0/4K@30Hz 4:4:4, Audio 2CH PCM 13 : HDMI 4K@60Hz 4:2:0/4K@30Hz 4:4:4, Audio 5.1CH DTS/DOLBY 14 : HDMI 4K@60Hz 4:2:0/4K@30Hz 4:4:4, Audio 7.1CH DTS/DOLBY/HD 15 : HDMI 4K@60Hz 4:4:4, Audio 2CH PCM 16 : HDMI 4K@60Hz 4:4:4, Audio 5.1CH DTS/DOLBY 17 : HDMI 4K@60Hz 4:4:4, Audio 7.1CH DTS/DOLBY/HD 18 : DVI 1280x1024@60Hz, Audio None 19 : DVI 1920x1080@60Hz, Audio None 20 : DVI 1920x1200@60Hz, Audio None 21 : HDMI 1920x1200@60Hz, Audio 2CH PCM/6CH PCM 22 : User EDID 1 23 : User EDID 2
EDID xx CP yy	Copy EDID From Output yy To Input xx xx = [00-04] : 00 : All Inputs ,Input 1 - 4 yy = [01-02] : Output 1 - 2
EDID SAVE yy TO zz	Save External EDID yy Into Slot zz yy = [01-04]: EDID Copy Output 1 - 4 yy = 00: EDID Via RS232 Send To Matrix zz = 00: All User EDID zz = 01 or 22: User EDID 1 zz = 02 or 23: User EDID 2
PRESET pp SAVE	Save Current Output Connections To Preset pp Config
PRESET pp CLR	Delete Preset pp Config pp = [00-09] : 00 : All Presets, Preset 1 - 9"
PRESET pp APPLY	Apply Preset pp Config To Output Connection pp = [01-09] : Presets 1 - 9"
OUT xx CEC ENABLE	Enable CEC Control On Output xx
OUT xx CEC DISABLE	Disable CEC Control On Output xx

# RS-232 Configuration and Telnet Commands

COMMAND	ACTION
OUT xx CEC OK	Confirm Operation (Enter) On Output xx
OUT xx CEC UP	UP On Output xx
OUT xx CEC DOWN	DOWN On Output xx
OUT xx CEC LEFT	LEFT On Output xx
OUT xx CEC RIGHT	RIGHT On Output xx
OUT xx CEC RETURN	RETURN On Output xx
OUT xx CEC EXIT	EXIT On Output xx
OUT xx CEC VOLUP	VOLUME UP On Output xx
OUTxx CEC VOLDDOWN	VOLUME DOWN On Output xx
OUT xx CEC MUTE	Toggle Audio MUTE Status On Output xx
OUT xx CEC PLAY	PLAY On Output xx
OUT xx CEC STOP	STOP On Output xx
OUT xx CEC PAUSE	PAUSE On Output xx
OUT xx CEC RECORD	RECORD On Output xx
OUT xx CEC INPUTyy	Input Channel yy Selection On Output xx, The Operation Needs To Wait For TV Communication To Succeed xx= 00: All Output Port xx= [01-02]: Output 1 - 2 yy= [01-04]: TV's HDMI Input 1 - 4 yy= [00]: Current HDMI Input yy= []:(No Parameter) Will Show Input Select Menu If TV Support
OUT xx CEC POFF	POWER OFF On Output xx
OUT xx CEC PON	POWER ON On Output xx xx= 00: All Output Port xx= [01-02]: Output 1 - 2
IN xx CEC ENABLE	Enable CEC Control On Input xx
IN xx CEC DISABLE	Disable CEC Control On Input xx
IN xx CEC OK	Confirm Operation (Enter) On Input xx
IN xx CEC UP	UP On Input xx
IN xx CEC DOWN	DOWN On Input xx
IN xx CEC LEFT	LEFT On Input xx
IN xx CEC RIGHT	RIGHT On Input xx
IN xx CEC RETURN	RETURN On Input xx
IN xx CEC EXIT	EXIT On Input xx
IN xx CEC VOLUP	VOLUME UP On Input xx
IN xx CEC VOLDDOWN	VOLUME DOWN On Input xx
IN xx CEC PLAY	PLAY On Input xx
IN xx CEC STOP	STOP On Input xx
IN xx CEC PAUSE	PAUSE On Input xx
IN xx CEC RECORD	RECORD On Input xx
IN xx CEC REWIND	REWIND On Input xx
IN xx CEC FF	FAST FORWARD On Input xx
IN xx CEC FWD	FORWARD On Input xx
IN xx CEC BWD	BACKWARD On Input xx
IN xx CEC POFF	POWER OFF On Input xx
IN xx CEC PON	POWER ON On Input xx xx= 00: All Output Port xx= [01-02]: Output 1 - 2

COMMAND	ACTION
CECUSER-CMD <u8 DevID u8Addr u8Opcode pu8Operand[MAX]>	Send Custom CEC Command u8DevID: 00 Select All CEC Input Port u8DevID: [01-04] Input 1 - 4 u8DevID: F0 Select All CEC Output Port u8DevID: [F1-F8] Output 1 - 2 pu8Operand[MAX] : MAX 0 - 14 Eg:CECUSERCMD <F0 40 44 41 > (ALL OUT CEC VOLUP) Eg:CECUSERCMD <F0 40 44 42 > (ALL OUT CEC VOLDDOWN)
RS232BAUD z	Set RS232 Baud Rate To xx z = 1 2400, 2 4800, 3 9600, 4 19200, 5 38400, 6 57600 (Default), 7 115200
RS232DLYOUT xx:tt	Set Send Output xx Interval Time In tt Seconds Between RS232 On And User Commands xx= 00: All Output Port xx= [01-02]: Output 1 - 2 tt= [0-180]: Delay tt Seconds
RS232OUT xx ON	Enable RS232 Remote-control Mode On HDBT Output xx
RS232OUT xx OFF	Disable RS232 Remote-control Mode On HDBT Output xx
RS232ONOUT xx y:z:a:b	Save y Type Of Command a Stored In Slot x Whose Baud Rate Is z On Output xx xx= 00: All Output Port xx= [01-02]: Output 1 - 2 y = 1 RS232 Display On y = 2 RS232 Display Input Select y = 3 RS232 User Command 1 y = 4 RS232 User Command 2 y = 5 RS232 User Command 3 z = a ASCII, h HEX a = 1 2400, 2 4800, 3 9600, 4 19200, 5 38400, 6 57600 (Default), 7 115200 b = RS232 Command
RS232OFFOUT xx z:a:b	Save RS232 Off Command a Of y Type Whose Baud Rate Is z On Output xx z = a ASCII, h HEX a = 1 2400, 2 4800, 3 9600, 4 19200, 5 38400, 6 57600 (Default), 7 115200 b = RS232 Command
RS232ONOUT xx DISABLE	Disable Auto RS232 Commands When Detecting A Signal On Output xx
RS232OFFOUT xx DISABLE	Disable Auto RS232 Commands When Not Detecting A Signal On Output xx xx= 00: All Output Port xx= [01-02]: Output 1 - 2
NET DHCP ON/OFF	Set Auto IP(DHCP) On Or Off
NET TN ON/OFF	Set Telnet Port On Or Off
NET TN8000 ON/OFF	Set Telnet Port 8000 On Or Off
NET IP xxx.xxx.xxx.xxx	Set IP Address
NET GW xxx.xxx.xxx.xxx	Set Gateway Address
NET SM xxx.xxx.xxx.xxx	Set Subnet Mask Address
NET RB	Set Network Reboot And Apply New Config!!!
NET TN xxxx	Set Telnet Port

# Web-GUI Firmware Update

The web-GUI of the Matrix is used to configure and control the product through a web portal. The Matrix can be accessed on any internet connected device including: tablets, smart phones and laptops that are on the same network.

As the web-GUI is used to update the main matrix firmware it is important to make sure that the web-GUI firmware is the latest version. Please check your firmware version against the version available to download from the Blustream website.

To update the web-GUI firmware:

1) Login to the web-GUI update menu:

Default IP Address is: [192.168.0.200:100](http://192.168.0.200:100)

Default Username is: [blustream](#) Default Password is: [1234](#)

Please note: the IP address may differ if default network settings have been updated. If this is the case, please replace the following with the products current IP address:

[XXX.XXX.XXX.XXX:100](#)

2) When you have accessed the web-GUI menu interface, expand the 'Administration' file in the menu tree by clicking the small '+' icon next to the file.

3) Select 'Upload Firmware':



4) Click 'Choose File' and select the web-GUI/MediaTek firmware file downloaded from the Blustream website. This will be a .bin file:

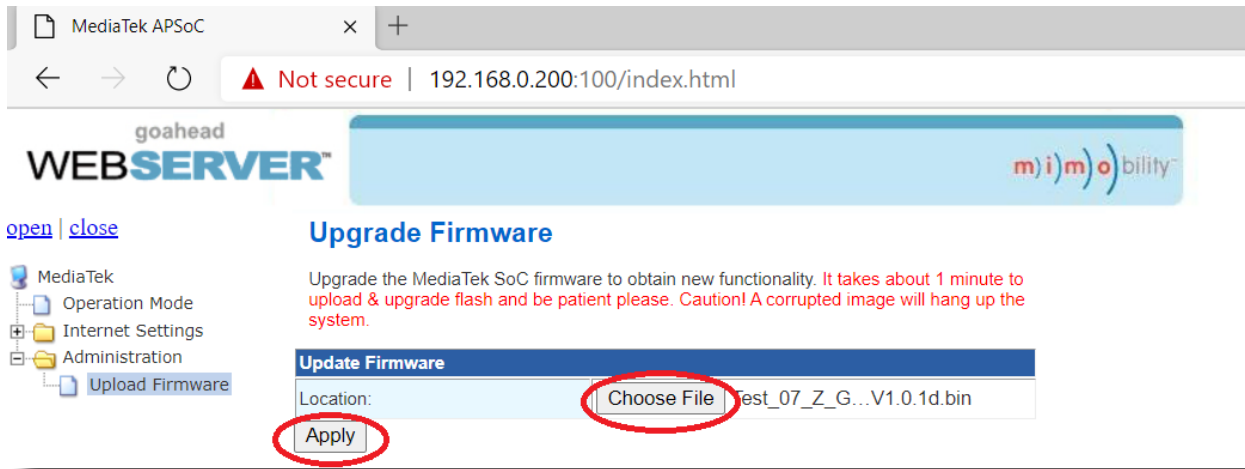

5) Press 'Apply' to begin the firmware update process.

The update process will take up to 1 minute to complete. Do not refresh or navigate away from this page until the update process has completed.

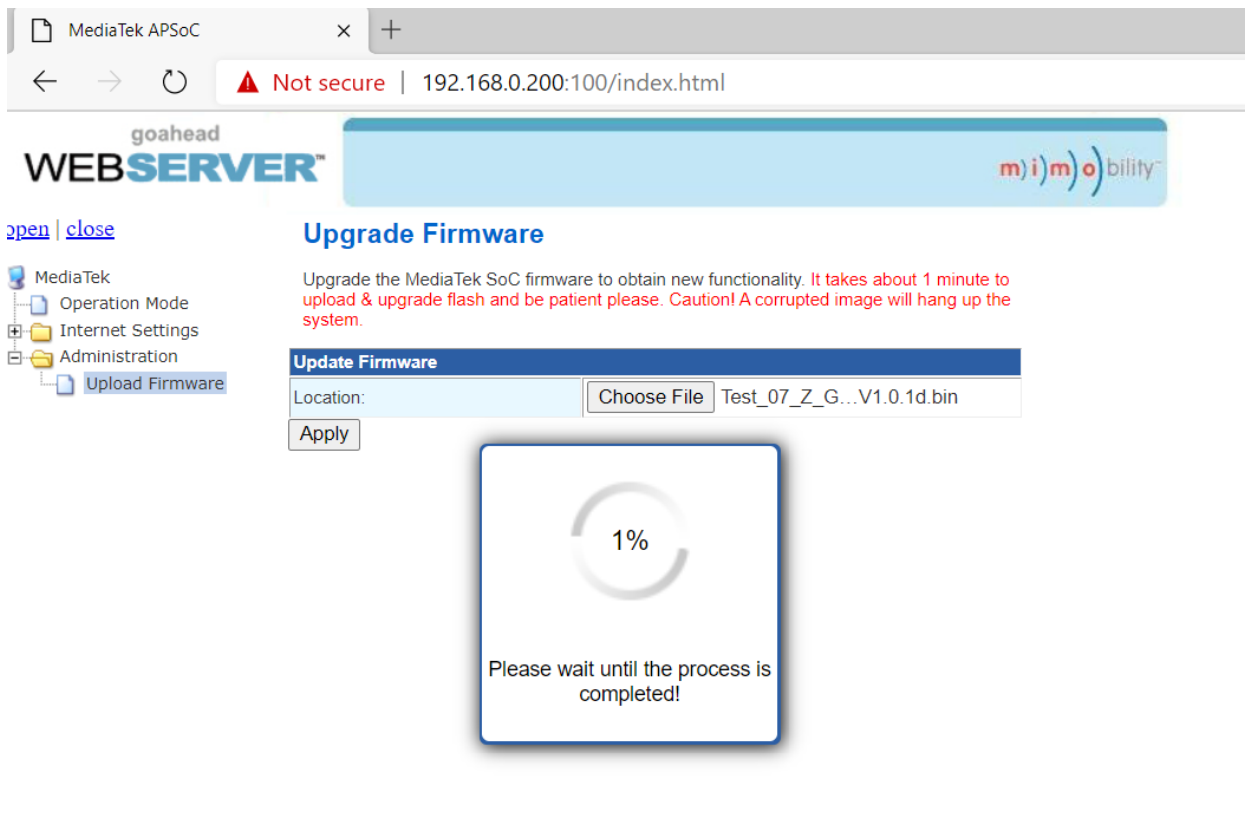



# Schematic

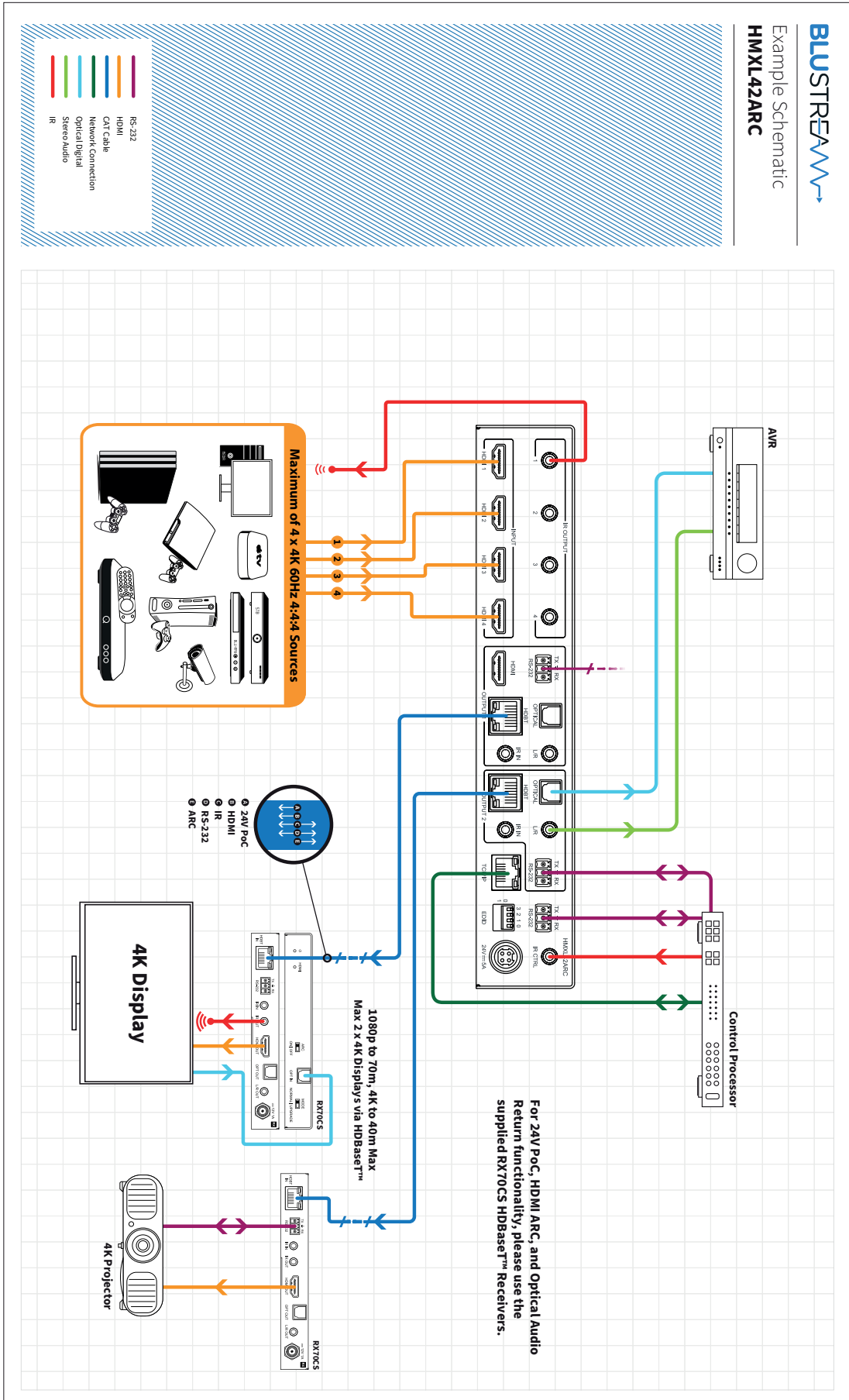

## Certifications

### FCC Notice

This equipment has been tested and found to comply with the limits for a Class B digital device, pursuant to part 15 of the FCC Rules. These limits are designed to provide reasonable protection against harmful interference in a residential installation. This equipment generates, uses, and can radiate radio frequency energy and, if not installed and used in accordance with the instructions, may cause harmful interference to radio communications. However, there is no guarantee that interference will not occur in a particular installation. If this equipment does cause harmful interference to radio or television reception, which can be determined by turning the equipment off and on, the user is encouraged to try to correct the interference by one or more of the following measures:

- Reorient or relocate the receiving antenna.
- Increase the separation between the equipment and receiver.
- Connect the equipment into an outlet on a circuit different from that to which the receiver is connected.
- Consult the dealer or an experienced radio/TV technician for help.

**CAUTION** - changes or modifications not expressly approved by the party responsible for compliance could void the user's authority to operate the equipment.

### CANADA, INDUSTRY CANADA (IC) NOTICES

This Class B digital apparatus complies with Canadian ICES-003.

Operation is subject to the following two conditions: (1) this device may not cause interference, and (2) this device must accept any interference, including interference that may cause undesired operation of the device.

### CANADA, AVIS D'INDUSTRY CANADA (IC)

Cet appareil numérique de classe B est conforme aux normes canadiennes ICES-003.

Son fonctionnement est soumis aux deux conditions suivantes : (1) cet appareil ne doit pas causer d'interférence et (2) cet appareil doit accepter toute interférence, notamment les interférences qui peuvent affecter son fonctionnement.

### CORRECT DISPOSAL OF THIS PRODUCT

This marking indicates that this product should not be disposed with other household wastes. To prevent possible harm to the environment or human health from uncontrolled waste disposal, recycle it responsibly to promote the sustainable reuse of material resources. To return your used device, please use the return and collection systems or contact the retailer where the product was purchased. They can take this product for environmentally safe recycling.





[www.blustream.com.au](http://www.blustream.com.au)  
[www.blustream-us.com](http://www.blustream-us.com)  
[www.blustream.co.uk](http://www.blustream.co.uk)