

GF162I - GF162TI

16x2" Line array column speaker - Passive - Passive with Transformer



Thank you for choosing KGEAR!

To ensure proper operation, please carefully read this owner's manual and safety instruction before using the product. After reading this manual, be sure to keep it for future reference. If you have any questions about your new device please contact K-array customer service at info@kgear.it or contact the local distributor in your country.

GF162I, GF162TI are the largest and minimalist line array elements of the GF family in a practical and compact column format and resistant frame. The GF162I and GF162T comprise 16x2" ferrite magnet woofers closely-spaced into a recycled ABS enclosure, featuring PAT (Pure Array Technology).

These columns speakers are the perfect solution for speech reproduction with high definition and intelligibility, thanks to their directivity and a narrow vertical dispersion, as well as music reproduction when coupled with a KGEAR subwoofer.

GF162TI has the feature of an internal transformer and it is compatible high voltage lines at 70V or 100V and has different power taps: 4/8/16/32 W @ 70V or 8/16/32/64W @ 100V.

Unpacking

Each KGEAR device is inspected before leaving the factory. Upon arrival, carefully inspect the shipping carton, then examine and test your new device. If you find any damage, immediately notify the shipping company. Check that the following parts are supplied with the product:

- 1 x GF162I - (GF162T) line array column speaker
- 1x Phoenix connector x GF162 (Euroblock 1,5/ 4-ST-3,81) Dedicated jumper cable to selectable impedance and connections
- 1x Phoenix connector x GF162TI (Euroblock 1,5/ 5-ST-3,81)
- 2x Wall mount L-bracket + screws and covers.



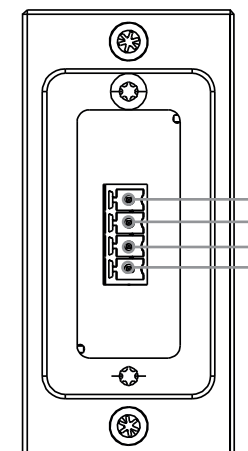
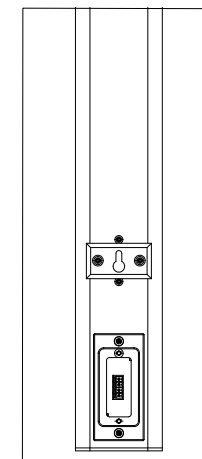
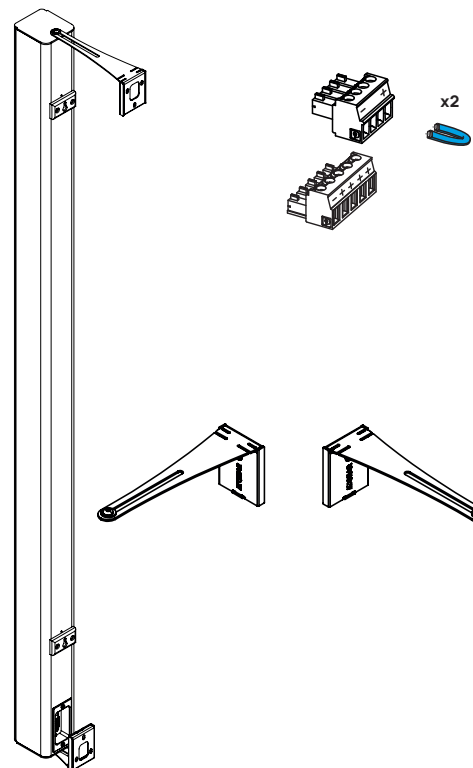

GF162I Rear Panel

GF162I passive speaker is equipped with 1x Phoenix connector compatible 4 pin - Euroblock 1,5/ 4-ST-3,81



GF162I Wiring

Signal polarity output and wiring of GF162 passive speaker:

GF162 - Wiring		
PIN 1		SIGNAL +
PIN 2		SIGNAL -
PIN 3		SIGNAL +
PIN 4		SIGNAL -

Impedance selection

With GF162I passive speaker the user can set the speaker @ Low impedance 8 Ω or @ High impedance 32 Ω. A dedicated jumper cable is provided to connect the two central pins of the Phoenix flying connector for the 32Ω configuration.

Impedance selection 8Ω Low-Z

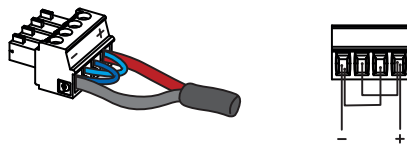

Impedance selection 32Ω High-Z

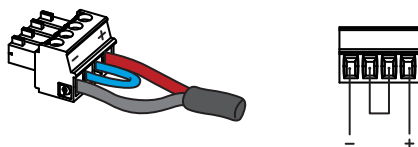





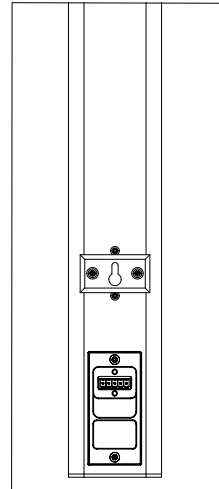



GF162TI Rear Panel

GF162TI passive speaker is equipped with 1x Phoenix connector compatible 5 pin - Euroblock 1,5/ 5-ST-3,81



TRANSFORMER'S POWER TAPS

GF162T - Wiring					
	70 V		100 V		
PIN 1	COMMON -		COMMON -		
PIN 2	4 W		8 W		
PIN 3	8 W		16 W		
PIN 4	16 W		32 W		
PIN 5	32 W		64 W		

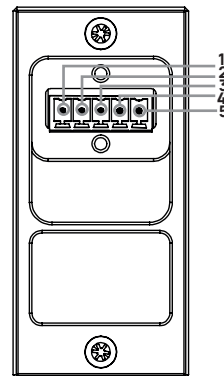

GF162TI Transformer wiring

GF162TI has the feature of an internal transformer and it is compatible with high voltage lines at 70V or 100V and has different power taps: 4/8/16/32 W @ 70V or 8/16/32/64 W 100 V.

This selector makes it easy to connect a large number of speakers in parallel with high power and efficiency and setting different output levels on each speakers, for every kind of space and use.

CONNECTORS

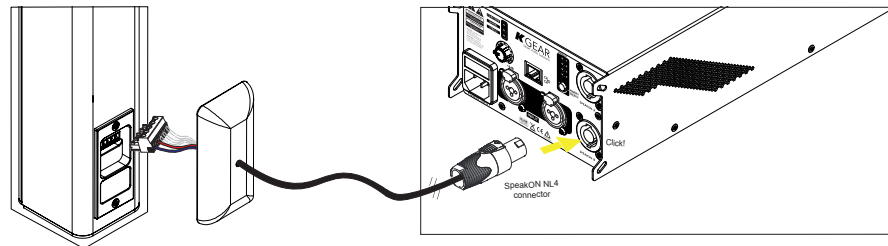
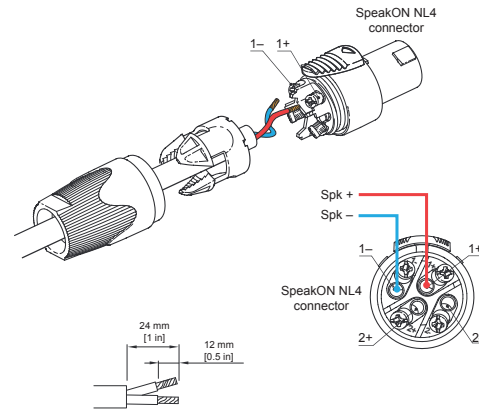

G-IPCAP - IP sealing accessory

GF162 I- GF162T I can be protected against foreign agents, salt, chlorine and water using the G-IPCAP1 and G-IPCAP2. This is a dedicated IP sealing CAP made by highly resistant and tight rubber, thought to be mounted at the rear panel of the speaker to protect connectors from water.

To install GF162 I with the dedicated accessory and for the correct wiring configuration, please following the procedures shown below:

3. Connect the wires to pins 1 - 4 of the provided Euroblock connector and plug it to the speaker terminals.
4. Use the jumper cables for the desired impedance configuration.

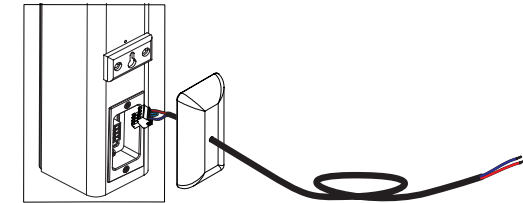

1. Take the dedicated accessory G-IPCAP1 and make a hole into the rubber material with a bradawl.
2. Choose a cable with a sheath for greater insulation and pass it through the hole.

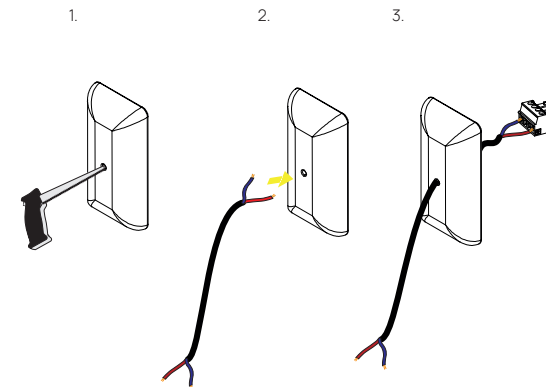

5. Ensure a secure fit by firmly pressing down the accessory's gasket to close the connector compartment.

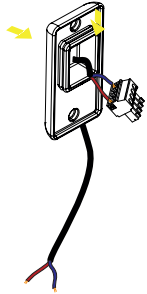

6. Connect the speaker to the dedicated amplifier channel. GF162I is finally installed with its dedicated G-IPCAP1 or G-IPCAP2 accessory.

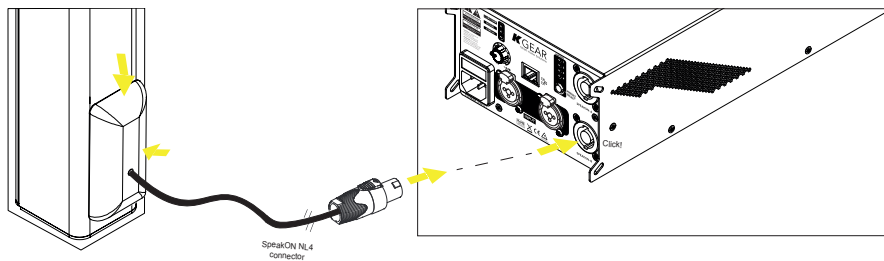

Example of configuration

It is possible to mount more GF elements in array setting, connecting each speaker with high impedance configuration. In this example, 8x GF162I are connected with the selected impedance and driven by a single channel of GA43L/ GA46L amplifier.

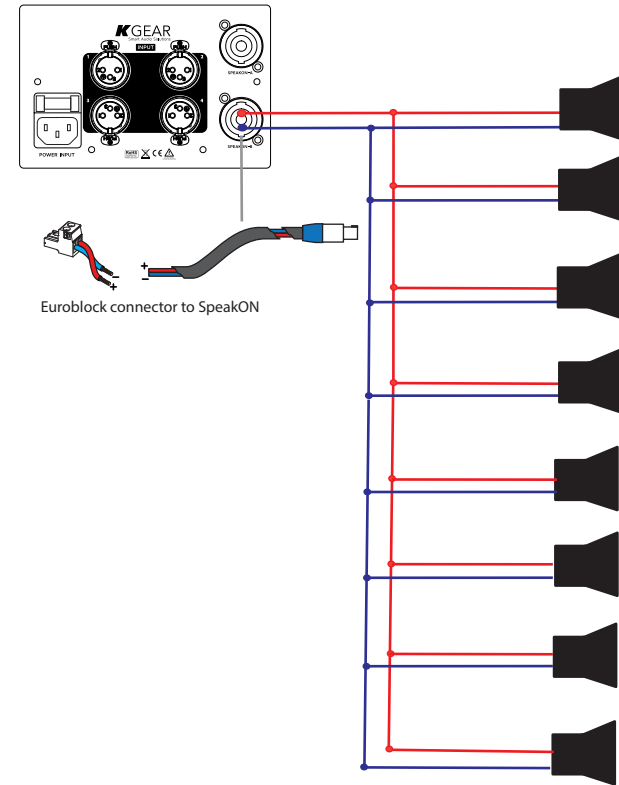

IMPORTANT SAFETY INSTRUCTIONS

CAUTION
RISK OF ELECTRIC SHOCK
DO NOT OPEN

ATTENTION: RISQUE DE CHOC ELECTRIQUE NE PAS OUVRIR

CAUTION: TO REDUCE THE RISK OF ELECTRIC SHOCK, DO NOT REMOVE COVER (OR BACK). NO USER-SERVICEABLE PARTS INSIDE. REFER SERVICING TO QUALIFIED SERVICE PERSONNEL.

- This symbol alerts the user to the presence of recommendations about the product's use and maintenance.
- The lightning flash with arrowhead symbol within an equilateral triangle is intended to alert the user to the presence of uninsulated, dangerous voltage within the product enclosure that may be of magnitude to constitute a risk of electrical shock.
- The exclamation point within an equilateral triangle is intended to alert the user to the presence of important operating and maintenance (servicing) instructions in this guide.
- Operator's manual; operating instructions
This symbol identifies the operator's manual that relates to the operating instructions and indicates that the operating instructions should be considered when operating the device or control close to where the symbol is placed.
- For indoor use only
This electrical equipment is designed primarily for indoor use.
- WEEE
Please dispose of this product at the end of its operational lifetime by bringing it to your local collection point or recycling center for such equipment.
- This device complies with Restriction of Hazardous Substances Directive.

General heed and warnings

Read these instructions.
 Keep these instructions.
 Heed all warnings.
 Follow all instructions.
 Do not use this apparatus near water.
 Clean only with dry cloth.
 Do not block any ventilation openings. Install in accordance with the manufacturer's instructions.
 Do not install near any heat sources such as radiators, heat registers, stoves, or other apparatus (including amplifiers) that produce heat
 Only use attachments/accessories specified by the manufacturer.
 Clean the product only with a soft and dry fabric. Never use liquid cleaning products, as this may damage the products cosmetic surfaces.
 Use only with the cart, stand, tripod, bracket, or table specified by the manufacturer, or sold with the apparatus. When a cart is used, use caution when moving the cart/apparatus combination to avoid injury from tip-over. Unplug this apparatus during lightning storms or when unused for long periods of time.
 Refer all servicing to qualified service personnel. Servicing is required when the apparatus has been damaged in any way, such as power-supply cord or plug is damaged, liquid has been spilled or objects have fallen into the apparatus, the apparatus has been exposed to rain or moisture, does not operate normally, or has been dropped.
CAUTION: These servicing instructions are for use by qualified service personnel only. To reduce the risk of electric shock, do not perform any servicing other than that contained in the operating instructions unless you are qualified to do so.

Warning. Failure to follow these safety instructions could result in fire, shock or other injury or damage to the device or other property.

These apparatus are intended for professional use.

Installation and commissioning may only be carried out by qualified and authorized personnel.

WARNING: Only use attachments/accessories specified or provided by the manufacturer (such as the exclusive supply adapter, battery, etc.)
 Use only speaker cables for connecting speakers to the speaker terminals. Be sure to observe the amplifier's rated load impedance particularly when connecting speakers in parallel. Connecting an impedance load outside the amplifier's rated range can damage the apparatus.
 KGEAR will not shoulder any responsibilities for products modified without prior authorization.

Service

To obtain service:
 Please have the serial number(s) of the unit(s) available for reference.
 Contact the official KGEAR distributor in your country: find the Distributors and Dealers list on www.kgear.com website. Please describe the problem clearly and completely to the Customer Service.
 You will be contacted back for on-line servicing.
 If the problem cannot be resolved over the phone, you may be required to send the unit in for service. In this instance, you will be provided with an RA (Return Authorization) number which should be included on all shipping documents and correspondence regarding the repair. Shipping charges are the responsibility of the purchaser.

Any attempt to modify or replace components of the device will invalidate your warranty. Service must be performed by an authorized K-array service center.

Cleaning

Use only a soft, dry cloth to clean the housing. Do not use any solvents, chemicals, or cleaning solutions containing alcohol, ammonia, or abrasives. Do not use any sprays near the product or allow liquids to spill into any openings.

Installation

According to Table 35 of IEC/EN 62368-1:2018, equipments are suitable for mounting at heights ≤ 2 m. Install in a well ventilated location at 35°C (95°F) max environment temperature.

GF162 I - GF162T I

Mechanical Drawings

GF162 I

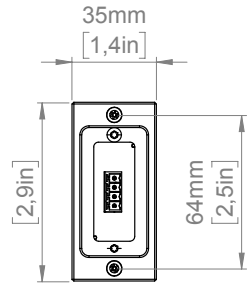

GF162T I

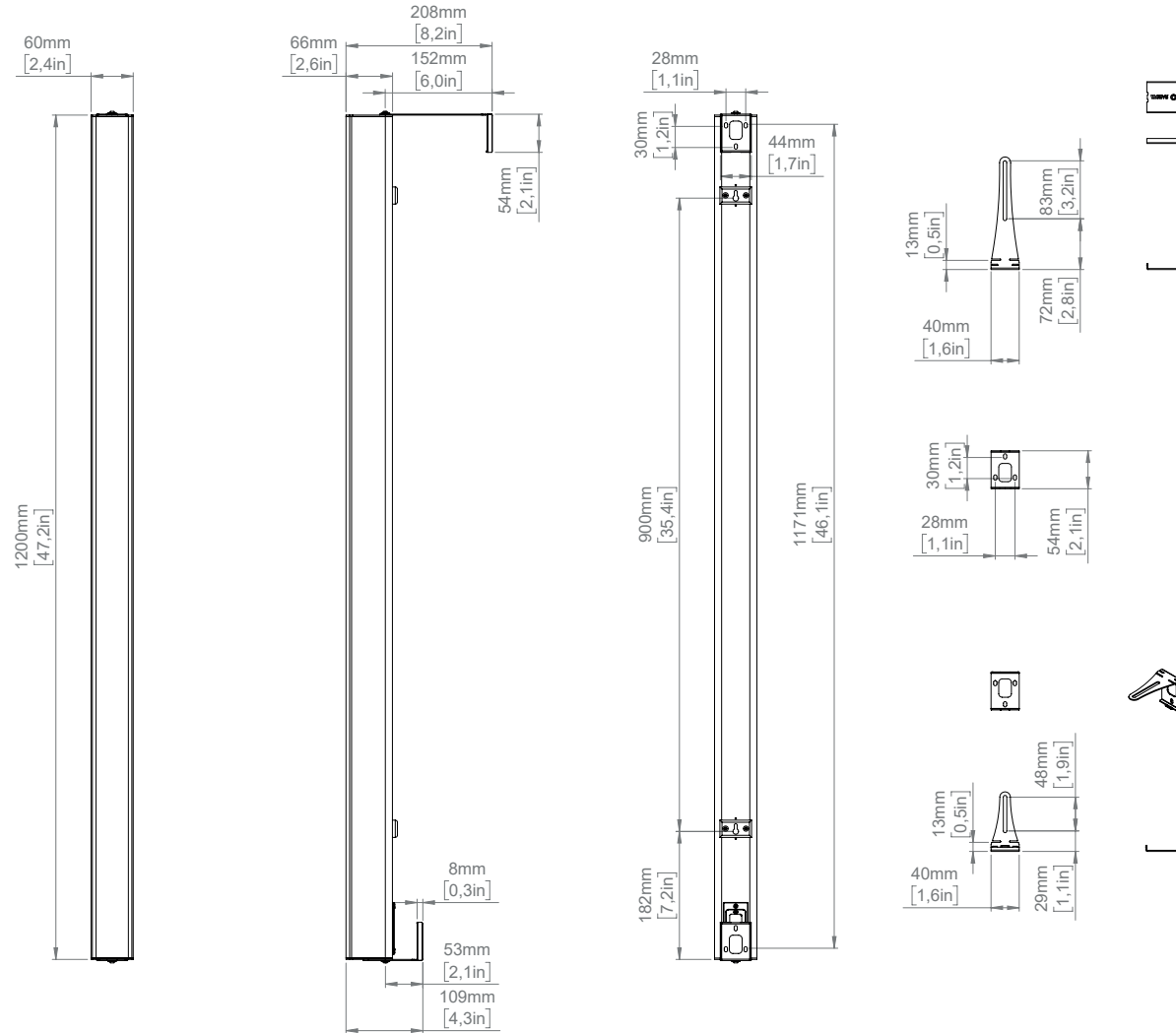
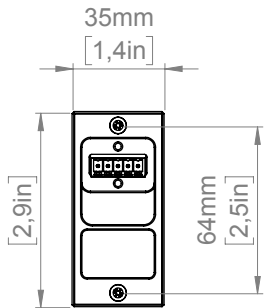

GF162 I

Technical specifications
Type Passive loudspeaker
Transducer 16 x 2" ferrite magnet woofer
Frequency Response ¹ 135 Hz - 20 kHz (-6dB)
Max SPL ² 123 dB Peak
Power Handling 400 W
Coverage V.7 I H.90°
Connectors 1x Phoenix connector (4-pin euroblock)
Nominal Impedance 8Ω - 32Ω
IP Rating IP54 (IP55 with G-IPCAP1 accessory)
Handling & Finishes
Dimensions (WxLxH) 60 x 1200 x 66 mm (2,36 x 47,24 x 2,56 in)
Weight 3,2 kg (7.05 lb)
Material ABS
Color Black - White (GF162W)

¹ With dedicated preset

² Maximum SPL is calculated using a signal with crest factor 4 (12 dB) measured at 8 m then scaled at 1 m

GF162T I

Technical specifications
Type Passive loudspeaker
Transducer 16 x 2" ferrite magnet woofer
Frequency Response ¹ 135 Hz - 20 kHz (-6dB)
Max SPL ² 115 dB
Rated Power 400 W
Transformer Taps 8/16/32/64 W 100V - 4/8/16/32 @ 70V
Coverage V.7 I H.90°
Connectors 1x Phoenix connector (5-pin Euroblock)
IP Rating IP54 (IP55 with G-IPCAP1 accessory)
Handling & Finishes
Dimensions (WxLxH) 60 x 1200 x 66 mm (2,36 x 47,24 x 2,56 in)
Weight 4.2 kg (9.25 lb)
Material ABS
Color Black - White (GF162TW)

¹ With dedicated preset

² Maximum SPL is calculated using a signal with crest factor 4 (12 dB) measured at 8 m then scaled at 1 m