

# ► NPA20ANA

## User Manual

## Thank you for purchasing this product.

For optimum performance and safety, please read these instructions carefully before connecting, operating or adjusting this product. Please keep this manual for future reference.



### Surge Protection Device Recommended

This product contains sensitive electrical components that may be damaged by electrical spikes, surges, electric shock, lightning strikes, etc. Use of surge protection systems is highly recommended in order to protect and extend the life of your equipment.

# Contents

Introduction	03
Features	03
Front Panel Description	04
Rear Panel Description	04
Speaker Connections	05
Trigger Connection	05
Analogue Line Audio Inputs/Outputs	06
Daisy Chain NPA20ANA/NPA20ARC Amplifiers	06
Web GUI Control	07-12
Schematic	13
Telnet & RS-232 Control Port	14-16
Specifications	16
Package Contents	16
Certifications	17

# Introduction

Our NPA20ANA networked power amplifier delivers advanced audio integration within a commercial or residential AV installation within smaller zones, or where voice re-enforcement is required.

The NPA20ANA features a 2 x 10W digital amplifier (1 x 20W mono) audio output with balanced / unbalanced analogue audio integration which can be powered via PoE or PoE+ from a compatible network switch, or locally should the switch not support PoE.

The unit also includes the ability to lower the amplifier power output subject to PoE capabilities, DSP with a 31 band EQ, audio delay for lip sync correction, daisy chain audio and control feature for linking up to 4x NPA20 devices and control via front panel, RS-232, TCP/IP, web-GUI or 12V trigger.

---

## FEATURES:

---

- Advanced network audio amplifier with balanced / unbalanced analogue audio integration
- Supports 2 x 10W @ 4 / 8 ohm, 1 x 20W @ 4 / 8 ohm
- Supports power via PoE+ on LAN connection or local power supply\*
- Supports 2ch balanced / unbalanced audio in and out with a master / slave amp control feature allowing daisy chaining of up to 4 x NPA20ARC or NPA20ANA amplifiers in line
- DSP with 31 band EQ with +3dB/-10dB and audio delay
- Local 0V / 5~12V input trigger for automated power control
- Control via front panel, RS-232 and IP
- Auto standby mode with signal sensing
- In-built web-GUI for setup and control

*\*Amp power limited when using PoE / PoE+*

## Front Panel Description

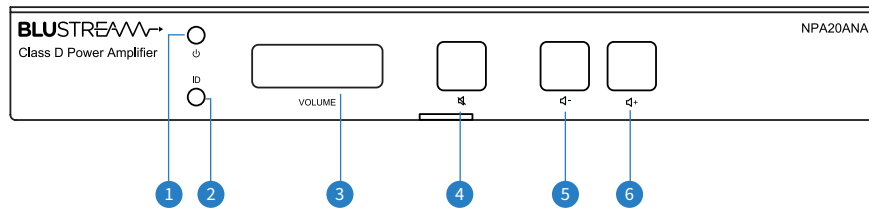

- 1 Power Status LED
- 2 ID LED - Illuminates to assist in identification of the device
- 3 Volume Level LED's - Illuminates to show current volume level
- 4 Volume Mute Button - Toggles audio mute on or off
- 5 Volume - Button - Decrease master output volume
- 6 Volume + Button - Increase master output volume

## Rear Panel Description

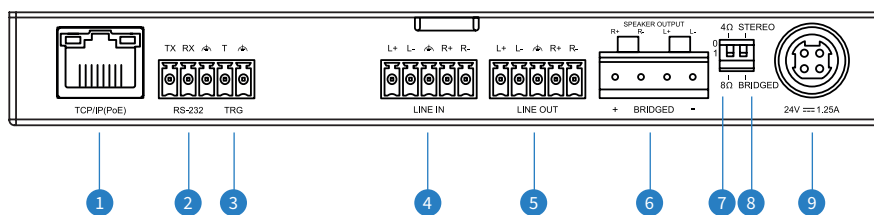

- 1 TCP/IP LAN Port - RJ45 connector supporting PoE+ to power NPA20ANA from the network switch and for for TCP/IP and web-GUI control of the device
- 2 RS-232 - Phoenix connector for RS-232 control of the device
- 3 Trigger Input - Phoenix connector triggers amplifier output on/off. Trigger voltage can be configured as high voltage (5~12V) or low voltage (0V) to mute amplifier output
- 4 Line In Analogue Audio Input - Connect to 2ch balanced/unbalanced L/R analogue audio source
- 5 Line Out Analogue Audio Output - 2ch balanced/unbalanced L/R analogue audio outputs, used to daisy-chain NPA amplifiers, or 3rd party audio products
- 6 Speaker Output - Phoenix connector for speaker outputs, see Speaker Connections section for more information
- 7 Speaker Impedance Switch - Select 4 or 8 ohm impedance to match to the connected speakers
- 8 Speaker Configuration - Select between a stereo or bridged wiring configuration for the speaker outputs
- 9 Power Port - Use 24V/1.25A DC power adaptor (not included) if not powered via PoE+ device

# Speaker Connections

The NPA20ANA supports low Impedance (4-8ohm) speakers. It is necessary to configure the Speaker Impedance Switch as well as wire up the speakers according to the specific speakers you are using. Wiring examples for each of the available configurations are as follows:

### Low Impedance (4-8ohm) Stereo Speakers:

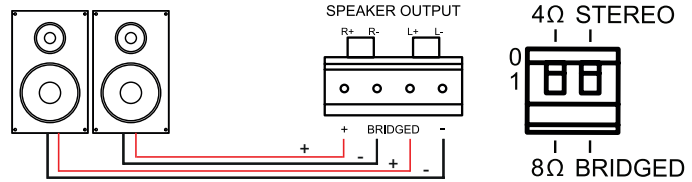

### Low Impedance (8ohm) Mono Speaker:

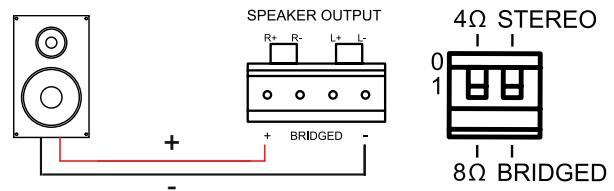

# Amplifier Output

The NPA20ANA amplifier is capable of outputting the same power at both 4 ohms and 8 ohms. The amplifier output power varies depending on the input power supply or PoE adapter connected to it, it does this by adjusting the internal gain to allow you to get the most of the amplifier. Please ensure that you select the correct impedance option via the speaker impedance selection switch on the rear of the device. For full power output, please order the PS241.25 power supply.

POWER SOURCE	WRMS PER CHANNEL @ 4/8 OHM	WRMS BRIDGED @ 8 OHM
24V/1.25A DC	2 x 10W	20W
PoE+ Type 2 Class 4	2 x 7.5W	15W
PoE Class 0	2 x 5W	10W

# Trigger Connection

The NPA20ANA features a trigger input to allow 3rd party devices to trigger the units power on or off. When the trigger input senses a low voltage level (0V), it will enable the amplifier output, while when it senses a high voltage level (5-12V) it will disable the amplifier out. This feature is enabled by default, and can be adjusted via the web-GUI, or control API.

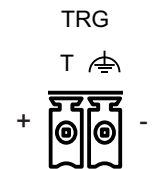

## Analogue Line Audio Inputs / Outputs

The 2 channel line inputs can be connected to a balanced or unbalanced audio source, or additional NPA20ARC or NPA20ANA amplifiers.

Both the analogue input and output can be wired with balanced or unbalanced audio devices with the pin out as adjacent.

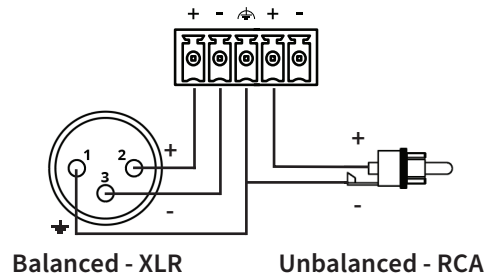

## Daisy Chaining NPA20ARC/NPA20ANA Amplifiers

When additional speakers are required in the zone, the NPA20ARC and NPA20ANA amplifiers have a daisy-chain audio and control feature allowing audio loop for up to 4 x amplifiers, but with a single point of control.

The first NPA20ARC/NPA20ANA amplifier is connected to an audio source device and 3rd party control system and configured as the 'Master Amplifier'. Additional NPA20ANA amplifiers can be daisy chained from the audio output of the master NPA amplifier to the audio input of the first slave amplifier, these are then configured as 'Slave Amplifiers'. You can have a single 'Master' amplifier (NPA20ARC or NPA20ANA), and 3x additional 'Slave' amplifiers (NPA20ANA).

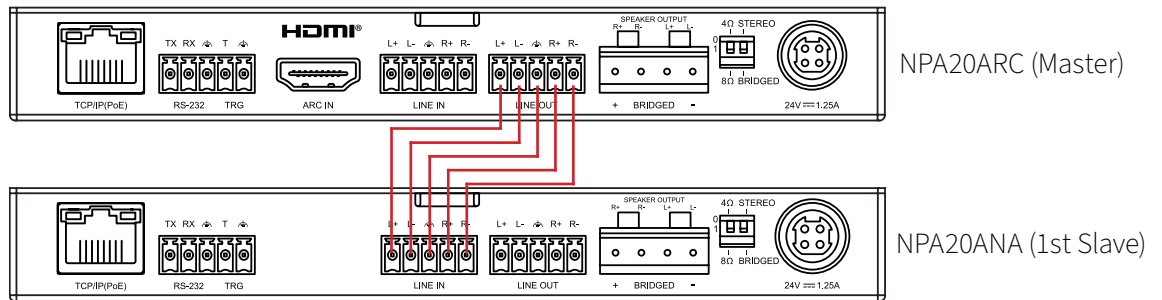

Configuration of the Master and Slave amplifiers can be achieved within the product web-GUI or via API. For further details see following pages.

## Web-GUI Control

The NPA20ANA features an in-built web-GUI for control and configuration of the unit. By default the device is set to DHCP, however if a DHCP server (eg: network router) is not installed, the device IP address will revert to below details:

Default **Username:** [blustream](#)

Default **Password:** [@BlS1234](#)

Default **IP Address:** [192.168.0.200](#)

The device can also be accessed via its mDNS name which is defaulted to: <http://NPA20ANA.local/>

The web-GUI supports multiple users along with multiple user permissions as follows:

**Guest Account** - This account does not require a user to login. The Guest account can only adjust the output volume of the NPA20ANA. Guest access can be enabled or disabled by the Admin if required.

**User Accounts** - User accounts can be utilised, each with individual login details. User accounts can be assigned permissions to specific areas and functions. A User must log in to make use of these functions.

**Admin Account** - This account allows full access to all functions of the unit as well as assigning users with permissions as required.

### Login Page:

The Login Page allows a user or admin to login and access additional functionality within the web GUI.

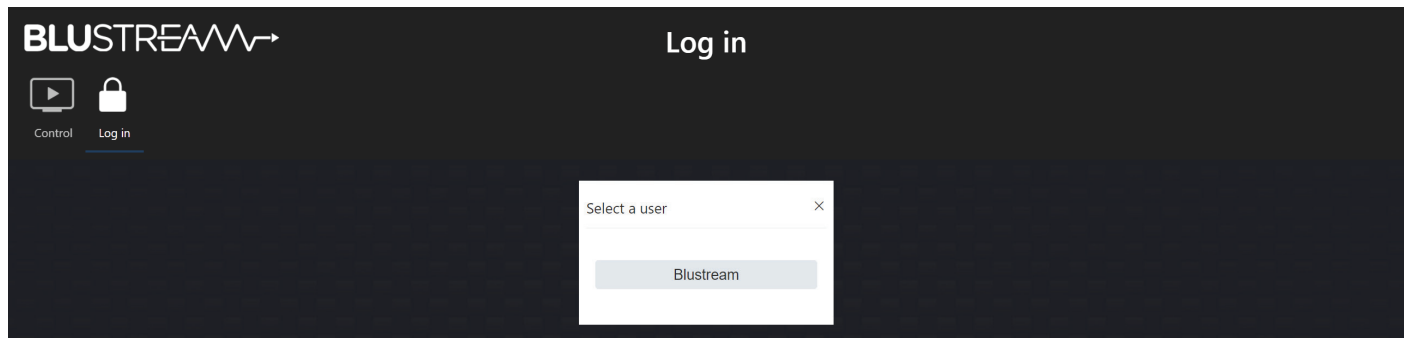

Once a user is selected from the list it is required to enter the password for that user in order to sign in.

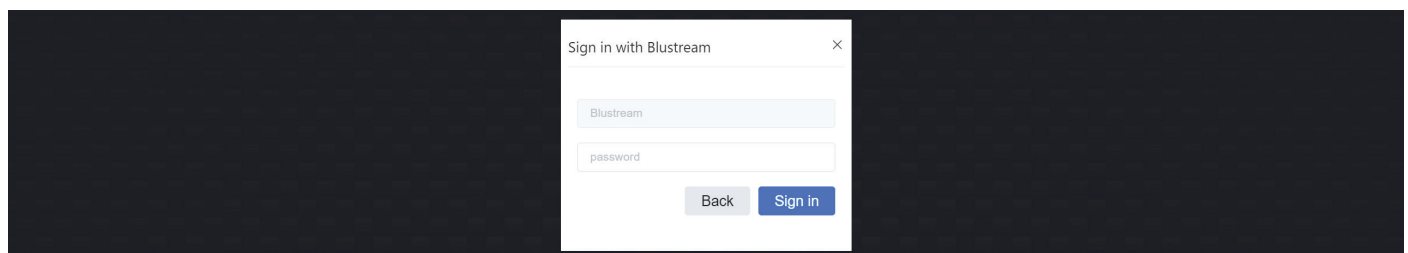

**Please note:** the first time the Admin logs into the web GUI, the default admin password will need to be changed. It is important to record this password as there is no way to recover it in the event that it is forgotten. The new password must be a minimum of 8 x characters, and contain at least one of the following: 1 x uppercase letter, 1 x lowercase letter, 1 x number, and 1 x symbol.

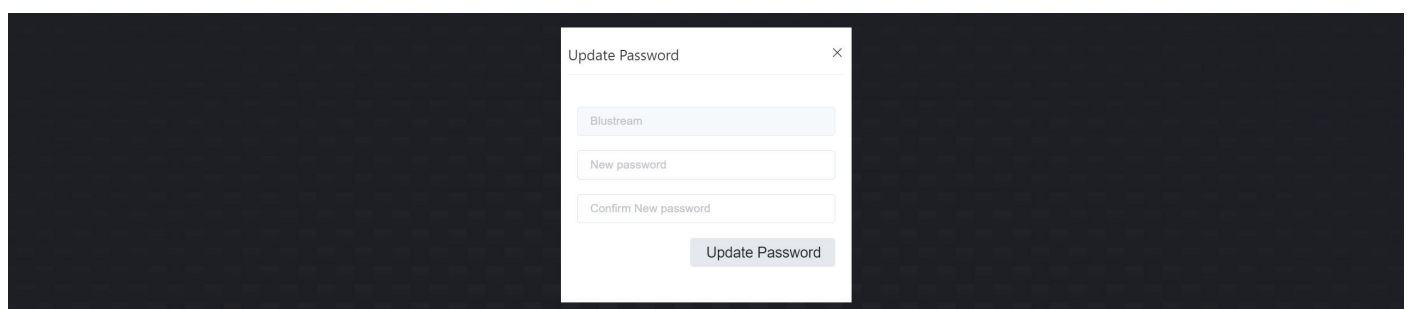

**Control Page:**

The Control page allows a user to adjust the audio levels for each input and the output. The Control page also includes input volume adjustment which can be used as an audio limit function to limit the maximum output volume. Additional control features include the ability adjust the signal mix (single channel only, stereo, or summed mono), audio delay, inversion, or 31 band graphic eq with +3dB / -10dB of adjustment.

The screenshot displays the BLUSTREAM Control interface with the following sections:

- Navigation:** A top menu with icons for Control, Settings, Users, System, Device Management, Information, Update Password, Log Out, and a Power button.
- Input Setting:** A slider for 'LINE' input volume ranging from -24dB to 24dB, currently set at 0dB.
- Output Setting:**
  - MASTER:** AMP and LINE toggle switches are ON. A volume slider is set to 40.
  - AMP:** Mix is STEREO. Delay is 0ms. L-Invert and R-Invert are OFF. Volume slider is set to 40.
  - LINE:** Mix is STEREO. Delay is 0ms. L-Invert and R-Invert are OFF. Output Gain is 0dBu. Volume slider is set to 40.
- GEQ Setting:** Channel is AMP. Equalizer is set to Flat. A 31-band graphic EQ is shown with all sliders at 0dB. Frequency labels range from 20 to 20K. A Reset button is located below the EQ.



**Settings Page:**

The Settings page allows users to change settings specific to the network configuration of the NPA20ANA such as the devices IP address and port settings. You can also adjust the mDNS or Domain Name for the device, which can also be used to access unit via, for example: http://NPA20ANA.local/

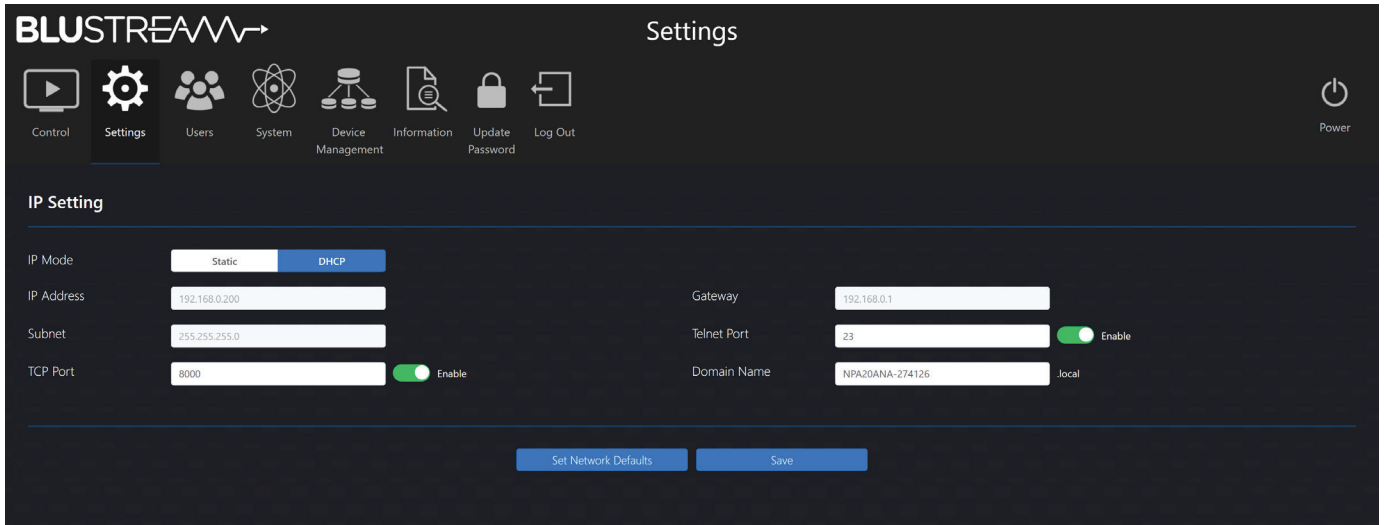

**User Page:**

The Users page allows the Admin to add, remove or disable users. Updating passwords of a user can be carried out from here also.

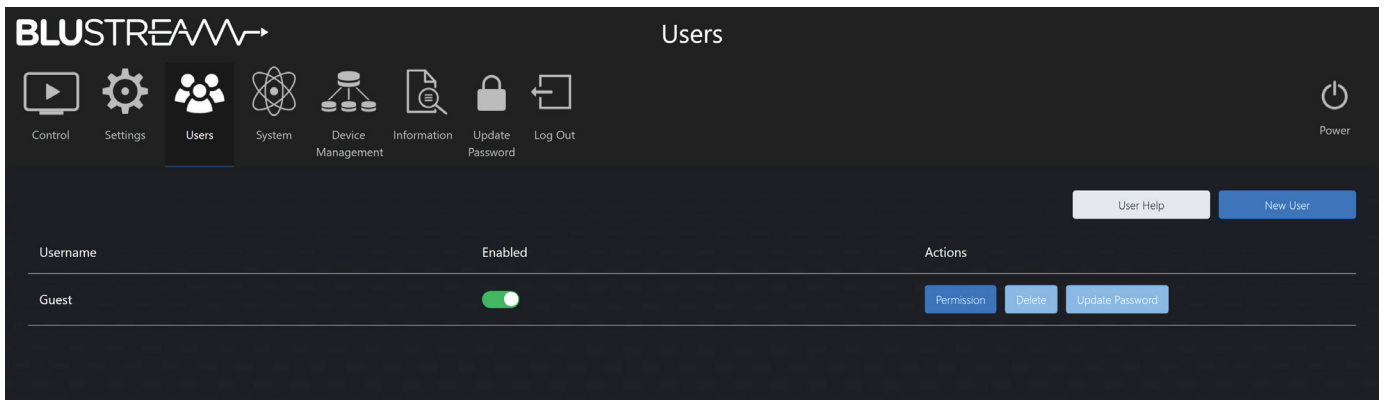

**Example: Guest Control Page:**

The guest Control page allows a guest to adjust the master output volume of the unit by using the volume slider or the volume up / down buttons as well as the mute toggle button. All other features are hidden.

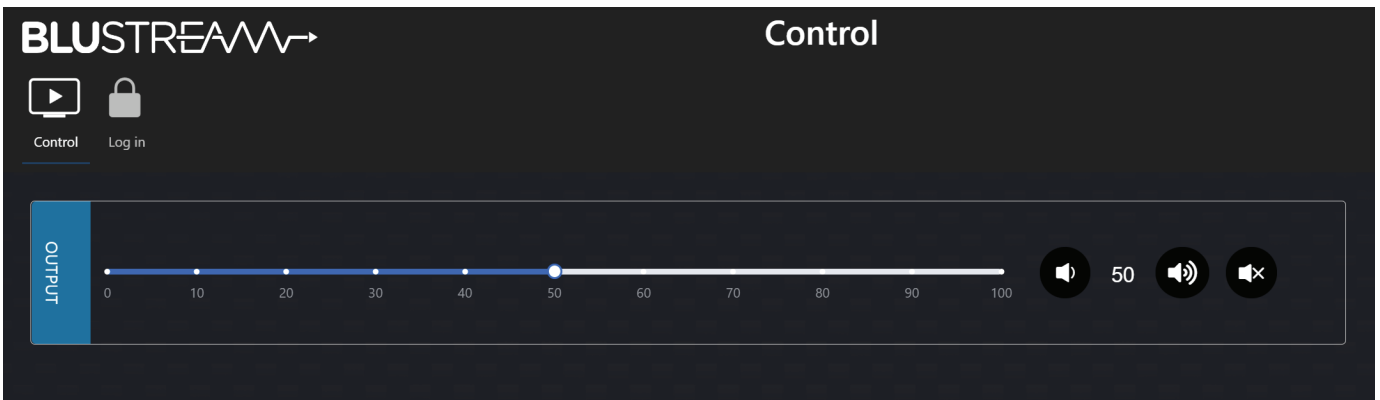

**System Page:**

The System page allows users to change the system configuration of the NPA20ARC such as:

- Identification - flashes the ID LED on front of the unit for the specified time period
- Key Lock On/Off - enable or disable to front panel keys from functioning
- Power On/Off - turn the unit on or off
- Power Mode - if the NPA20ANA is connected to a DC power supply, then PoE power modes will not be selectable. If the NPA20ANA is connected via PoE, it will default to the minimum PoE power specification (PoE Class 0). It is recommended to set this to the PoE power specification of the PoE adapter powering the NPA20ANA
- Input Trigger On/Off - enable or disable input trigger function
- Front Panel Lights - enable or disable front panel LED lights, or time out after selected time (15, 30 or 60 seconds)
- Serial Baud Rate - specify the baud rate of the serial RS-232 port on the device
- Auto Standby Time (minutes) - specify the time in minutes where the unit will enter standby mode if no audio signal is being received on the selected input (default is 10 minutes)
- Firmware Update (MCU / DEP SDK) - allows a user to update the firmware of the device
- Factory Reset (excludes Network Settings) - factory defaults all settings except for network configuration
- Factory Reset (includes Network Settings) - factory defaults all settings including network configuration
- Reboot - power cycles the unit without changing any configuration settings

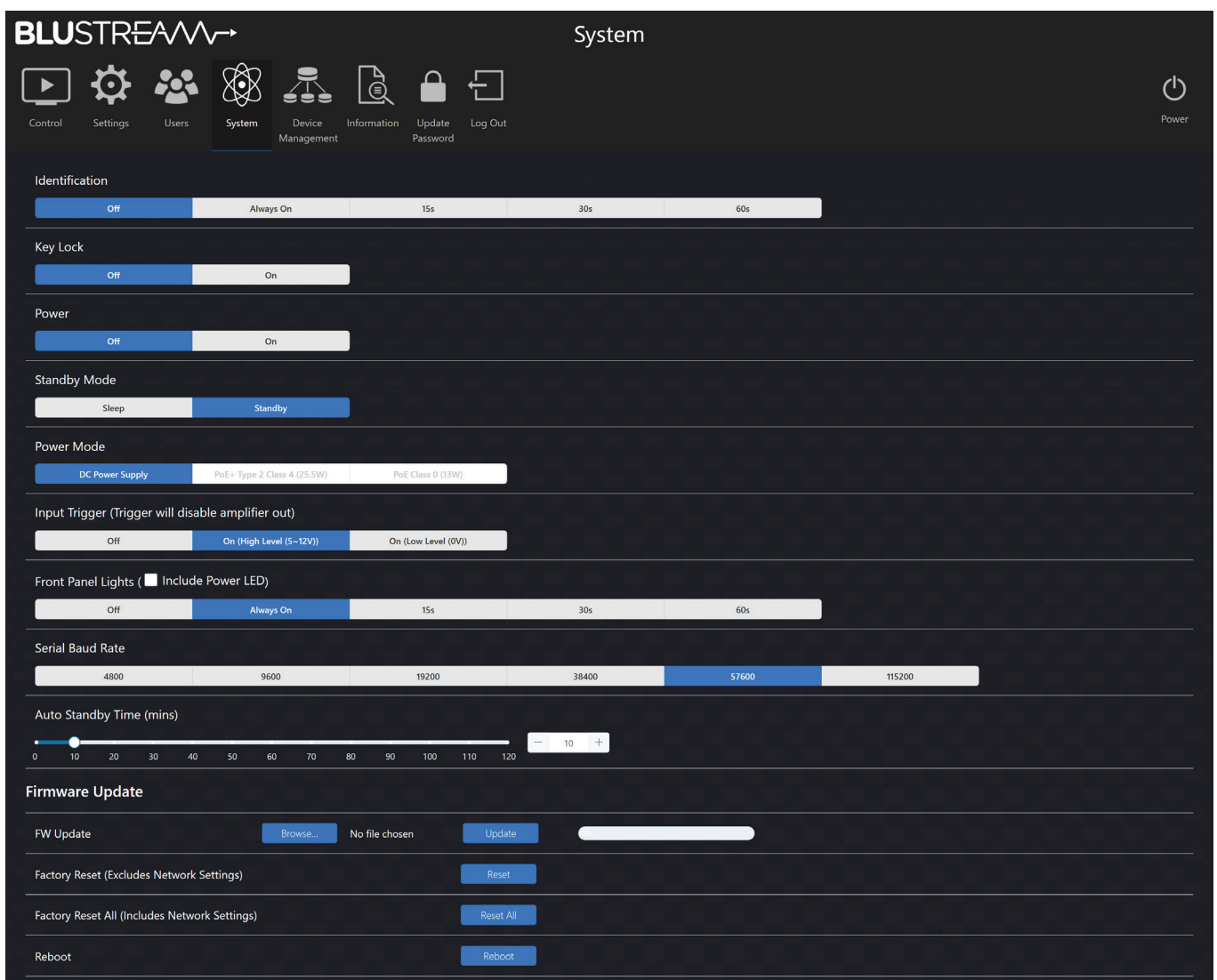

**Device Management Page:**

When additional speakers are required in the zone the NPA20ANA and NPA20ARC amplifiers have a daisy-chain audio and control feature allowing audio loop for up to a further 3 x NPA20xxx amplifiers (4 x amplifiers maximum), but with a single point of control.

The first NPA20ARC/NPA20ANA amplifier is connected to an audio source device and 3rd party control system and configured as ‘Master Amplifier’. Any additional amplifiers will be connected from the audio output of the master NPA amplifier and configured as ‘Slave Amplifiers’ (looping the audio output to the audio input).

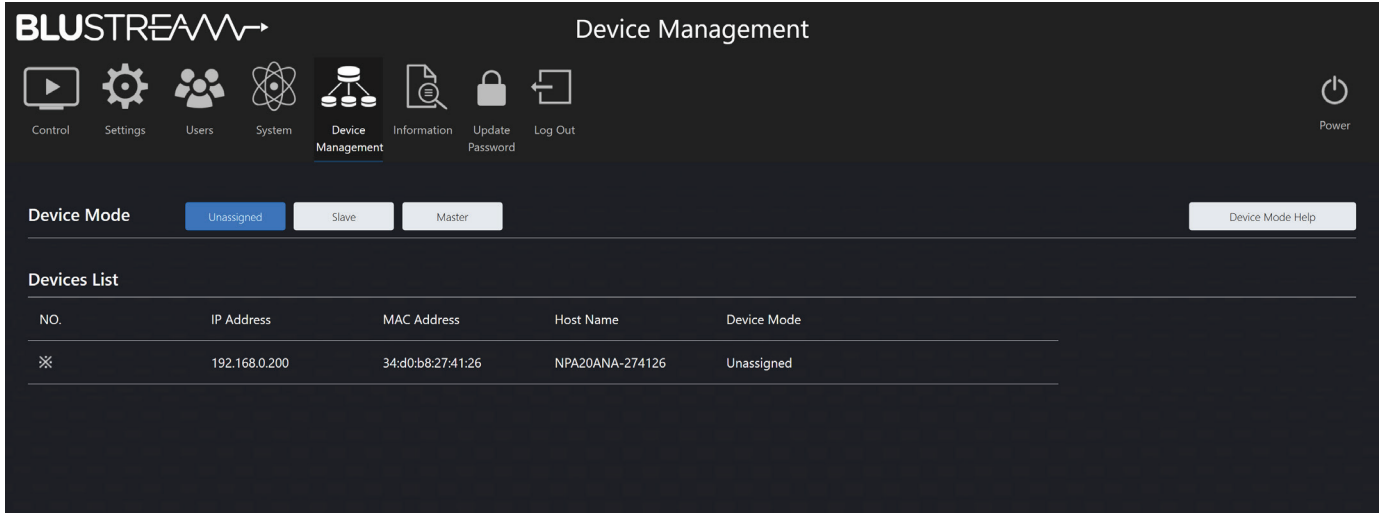

To configure this feature you must choose a ‘MASTER’ amplifier and all other amplifiers must be configured as ‘SLAVE’ amplifiers. Both the Master and Slave amplifier/s must be set to the same group in order to be controlled as a single device. 3rd Party control products must be connected to the MASTER NPA20xx amplifier for this feature to work.

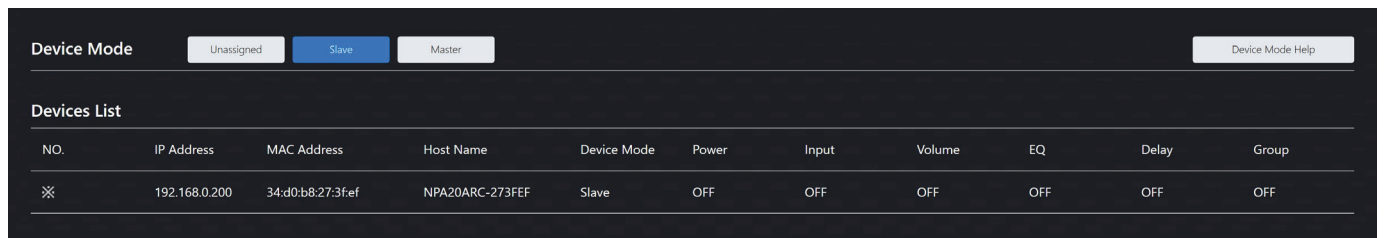
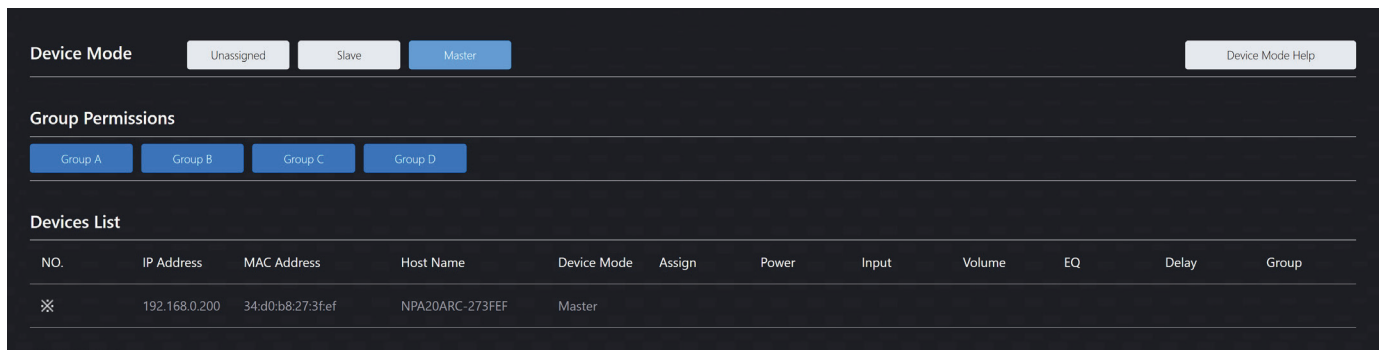

If using the product standalone, please select ‘UNASSIGNED’.

**Information Page:**

The Information page provides useful information such as firmware version and network settings.

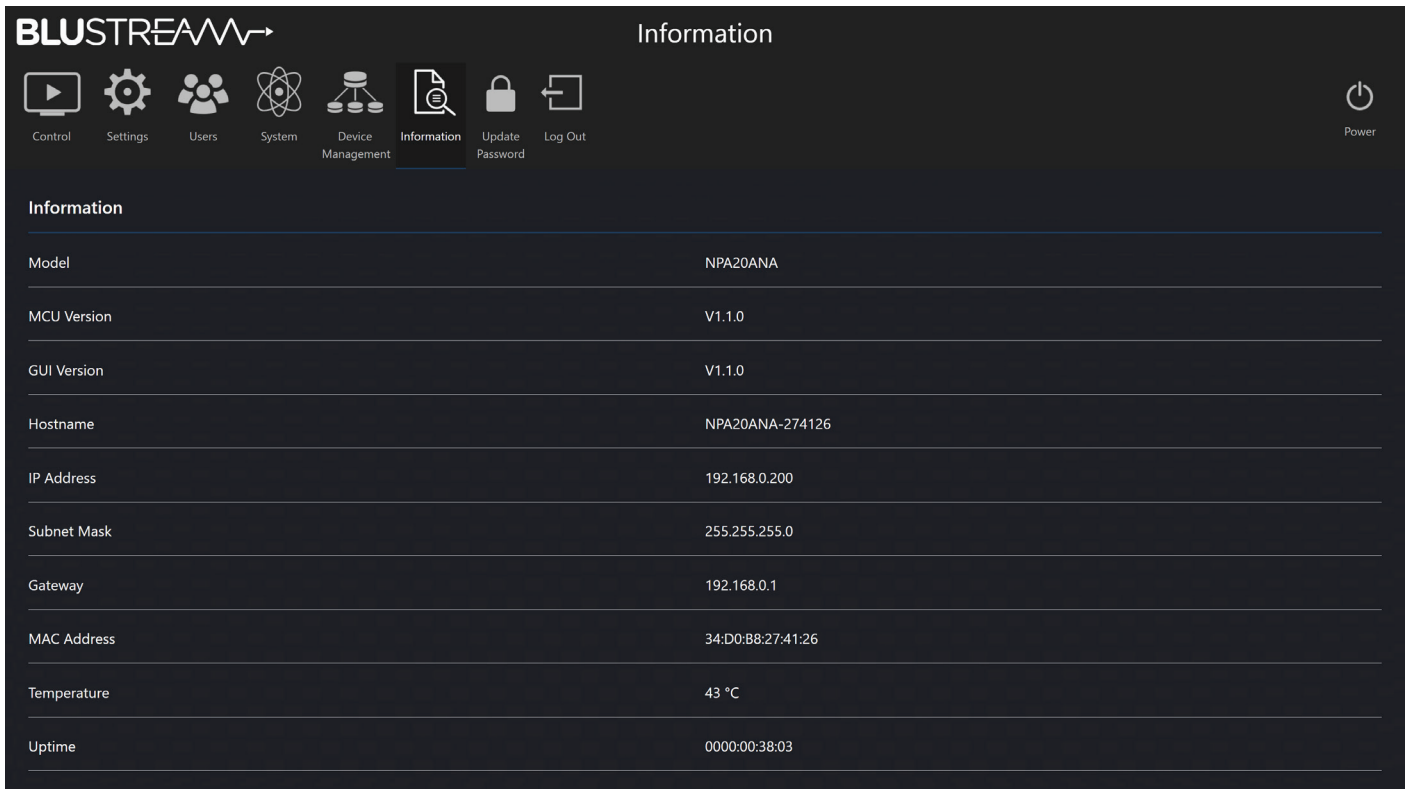

The screenshot displays the 'Information' page of the BLUSTREAM web interface. At the top, there is a navigation menu with icons for Control, Settings, Users, System, Device Management, Information (highlighted), Update Password, and Log Out. A Power button is located in the top right corner. The main content area is titled 'Information' and contains a table of system details.

Information	
Model	NPA20ANA
MCU Version	V1.1.0
GUI Version	V1.1.0
Hostname	NPA20ANA-274126
IP Address	192.168.0.200
Subnet Mask	255.255.255.0
Gateway	192.168.0.1
MAC Address	34:D0:B8:27:41:26
Temperature	43 °C
Uptime	0000:00:38:03



## Telnet & RS-232 Control Port

The NPA20ANA can be controlled via a 3-pin Phoenix to serial RS-232 cable or via Telnet.

The RS-232 communication settings and commands are as follows:

Baud Rate: 57600 bps

Parity: None

Flow Control: None

Data Bit: 8-bit

Stop Bit: 1-bit

RS-232 / TELNET COMMAND	DESCRIPTION
?/HELP	Print Help Information
STATUS	Print System Status And Port Status
TEMP	Print System Temperature
UPTIME	Print System Uptime
PON	Power On, System Run On Normal State
POFF	Power Off, System Run On Power Save State
PWLED FOLLOW ON/OFF	ON: Set System Power Led Follow LCD Status OFF: Set System Power Led Not Follow LCD Status In Power On State,Power Led Always On
RESET	"Reset System Settings To Default (Should Type ""Yes"" To Confirm, ""No"" To Discard)"
RESET ALL	"Reset System and Network Settings To Default (Should Type ""Yes"" To Confirm, ""No"" To Discard)"
REBOOT	Set System Reboot
AUTO STB xx	Set System Auto Standby Time xx=0:Auto Standby Off xx=[1...120]:Auto Standby Time,(mins)
STANDBY xx	Set System Standby Mode To xx xx=0:Sleep, 1:Standby
AMPMODE xxx	Set Amp Power to xxx xx=1:PoE+ Type 2 Class 4 (25.5W) xx=2:PoE Class 0 (13W)
KEY ON/OFF	Set System KEY Control On Or Off
LCD ON/OFF/15/30/60	Set LCD Always On Or Auto Turn Off In Power On State Or Turn On 15s/30s/60s
IDLED ON/OFF/15/30/60	Set IDLED On Or Auto Turn Off In 15/30/60s In Power On State Or Turn On 15s/30s/60s
TRIG ON/OFF yy	Set Trigger On Or Off With Trigger Level:yy yy=0:Low Level(0V) Mute Output yy=1:High Level(5 - 12V) Mute Output
RSB xx	Set RS232 Baud Rate to xx bps xx=[1...6]:1:4800,2:9600,3:19200, 4:38400,5:57600,6:115200
IN xx GAIN yy	Set Input:xx Gain To yy xx=[0...2]:0:All, 1:LINE, 2:HDMI ARC yy=[-24...24]:Input Gain Value For LINE yy=[-12...12]:Input Gain Value For HDMI ARC
IN xx GAIN+	Increase Input:xx Gain xx=[0...2]:0:All, 1:LINE, 2:HDMI ARC
IN xx GAIN-	Decrease Input:xx Gain xx=[0...2]:0:All, 1:LINE, 2:HDMI ARC
VOL+ yy	Increase System Volume yy=[1...100]:Steps yy Can Be Empty (1 Step)

RS-232 / TELNET COMMAND	DESCRIPTION
VOL-yy	Decrease System Volume yy=[1...100]:Steps yy Can Be Empty (1 Step)
VOLxx	Set System Volume Value To xx xx=[0...100]:Volume Value
MUTE ON/OFF	Set Mute On Or Off
MASTERxx	Set Output Master Includes xx xx=[0...3]:0:All, 1:AMP Only, 2:LINE Only, 3:None
OUT xx VOL yy	Set Output:xx Volume To yy xx=[0...2]:0:ALL, 1:AMP, 2:LINE
OUT xx VOL+ yy	Increase Output:xx Volume xx=[0...2]:0:ALL, 1:AMP, 2:LINE yy=[1...100]:Steps yy Can Be Empty (1 Step)
OUT xx VOL- yy	Decrease Output:xx Volume xx=[0...2]:0:ALL, 1:AMP, 2:LINE yy=[1...100]:Steps yy Can Be Empty (1 Step)
OUT xx MUTE ON/OFF	Set Output:xx Mute On Or Off xx=[0...2]:0:ALL, 1:AMP, 2:LINE
OUT xx GAIN yy	Set Output:xx Gain To yy xx=[0...1]:0:All, 1:LINE yy=[0...15]:0:+20dBu, 1:+18dBu, 2:+15dBu, 3:+12dBu 4:+9dBu, 5:+6dBu, 6:+4dBu, 7:0dBu 8:0dBV, 9:-3dBV, 10:-6dBV, 11:-10dBV 12:-14dBV, 13:-20dBV, 14:-24dBV, 15:-28dBV
OUT xx DLYT yy	Set Output:xx Delay Time To yy(ms) xx=[0...2]:0:ALL, 1:AMP, 2:LINE yy=[0...100]:Delay Time, Millisecond
OUT xx REVB ON/OFF	Set Output:xx Reverb On Or Off xx=[0...2]:0:ALL, 1:AMP, 2:LINE
OUT xx PHASE yy INV ON/OFF	Set Output:xx L-Invert Or R-Invert On Or Off xx=[0...2]:0:ALL, 1:AMP, 2:LINE yy=[0,1]:0:LEFT, 1:RIGHT
OUT xx MIX yy	Set Output:xx Mix yy xx=[0...2]:0:ALL, 1:AMP, 2:LINE yy=[1,2]:1:STEREO, 2:LEFT-CH yy=[3,4]:3:RIGHT-CH, 4:LEFT-CH And RIGHT-CH
OUT xx EQ yy VAL zz	Set Output:xx GEQ:yy To zz xx=[0...2]:0:ALL, 1:AMP, 2:LINE yy=[1...31]:EQ Index zz=[-10...3]:EQ Value
OUT xx EQ PRESET yy	Set Output:xx GEQ To Preset:yy xx=[0...2]:0:ALL, 1:AMP, 2:LINE yy=[1...3]:1:Flat, 2:Custom1, 3:Custom2

RS -232 / TELNET COMMAND	DESCRIPTION
NET DHCP ON/OFF	Set Auto IP(DHCP) On Or Off
NET IP xxx.xxx.xxx.xxx	Set IP Address
NET GW xxx.xxx.xxx.xxx	Set Gateway Address
NET SM xxx.xxx.xxx.xxx	Set Subnet Mask Address
NET TCPPORT ON/OFF	Set TCP/IP On Or Off
NET TCPPORT xxxx	Set TCP/IP Port
NET TN ON/OFF	Set Telnet Port On Or Off
NET TN xxxx	Set Telnet Port
NET RB	Network Reboot and Apply New Config!!!
NET DNS xxxx	Set DNS Domain Name To xxxx

## Specifications

### NPA20ANA

- **Audio Inputs:** 1 x 5-pin Phoenix connector (balanced/un-balanced analogue audio)
- **Audio Outputs:** 1 x 5-pin Phoenix connector (balanced/un-balanced analogue audio)
- **Speaker Outputs:** 1 x 4-Pin Phoenix connector (4 / 8 ohm speaker)
- **RS-232 Serial Port:** 1 x 3-Pin Phoenix connector
- **Trigger Input:** 1 x 2-Pin Phoenix connector
- **Casing Dimensions (W x H x D):** 169mm x 144mm x 22mm
- **Shipping Weight:** 1.2kg
- **Operating Temperature:** 32°F to 104°F (0°C to +40°C)
- **Storage Temperature:** -4°F to 140°F (-20°C to +60°C)
- **Power Supply:** PoE+ Type 2 Class 4, or 24V/1.25A DC 4-pin DIN  
(power supply not included)

### AMP POWER SPECIFICATION

POWER SOURCE	AMP OUTPUT
24V/1.25A DC	20W
PoE+ Type 2 Class 4	15W
PoE Class 0	10W

**NOTE:** Specifications are subject to change without notice. Weights and dimensions are approximate.

## Package Contents

### NPA20ANA

- 1 x NPA20ANA
- 1 x Mounting kit
- 1 x Quick Reference Card



## Certifications

### FCC Notice

This equipment has been tested and found to comply with the limits for a Class B digital device, pursuant to part 15 of the FCC Rules. These limits are designed to provide reasonable protection against harmful interference in a residential installation. This equipment generates, uses, and can radiate radio frequency energy and, if not installed and used in accordance with the instructions, may cause harmful interference to radio communications. However, there is no guarantee that interference will not occur in a particular installation. If this equipment does cause harmful interference to radio or television reception, which can be determined by turning the equipment off and on, the user is encouraged to try to correct the interference by one or more of the following measures:

- Reorient or relocate the receiving antenna.
- Increase the separation between the equipment and receiver.
- Connect the equipment into an outlet on a circuit different from that to which the receiver is connected.
- Consult the dealer or an experienced radio/TV technician for help.

**CAUTION** - changes or modifications not expressly approved by the party responsible for compliance could void the user's authority to operate the equipment.

### CANADA, INDUSTRY CANADA (IC) NOTICES

This Class B digital apparatus complies with Canadian ICES-003.

Operation is subject to the following two conditions: (1) this device may not cause interference, and (2) this device must accept any interference, including interference that may cause undesired operation of the device.

### CANADA, AVIS D'INDUSTRY CANADA (IC)

Cet appareil numérique de classe B est conforme aux normes canadiennes ICES-003.

Son fonctionnement est soumis aux deux conditions suivantes : (1) cet appareil ne doit pas causer d'interférence et (2) cet appareil doit accepter toute interférence, notamment les interférences qui peuvent affecter son fonctionnement.

### CORRECT DISPOSAL OF THIS PRODUCT

This marking indicates that this product should not be disposed with other household wastes. To prevent possible harm to the environment or human health from uncontrolled waste disposal, recycle it responsibly to promote the sustainable reuse of material resources. To return your used device, please use the return and collection systems or contact the retailer where the product was purchased. They can take this product for environmentally safe recycling.





[www.blustream.com.au](http://www.blustream.com.au)

[www.blustream-us.com](http://www.blustream-us.com)

[www.blustream.co.uk](http://www.blustream.co.uk)