

NEXUS™ **4x4**

User Manual

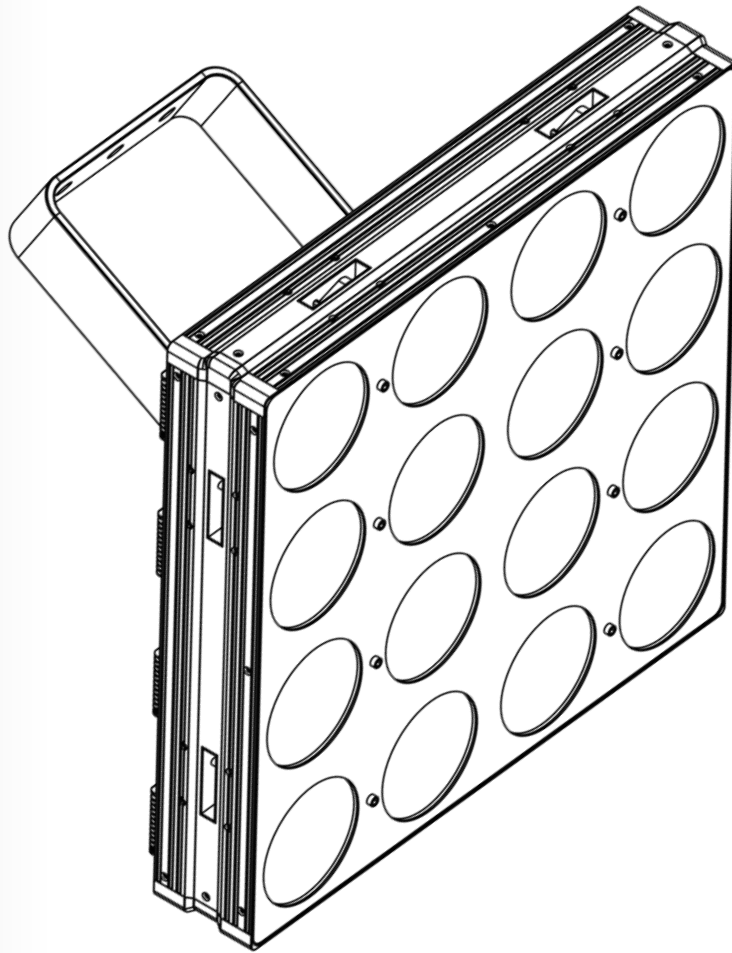

CHAUVET®
PROFESSIONAL
It's **Green** Thinking.

Edition Notes This User Manual covers the description, safety precautions, installation, programming, operation, and maintenance of the Nexus™ 4x4.

Chauvet released this edition of the Nexus™ 4x4 User Manual in November 2014.

Trademarks CHAUVET® is a registered trademark of CHAUVET & Sons Inc. (d/b/a CHAUVET® or Chauvet). The CHAUVET® logo in its entirety including the CHAUVET® name and the dotted triangle, and all other trademarks in this manual pertaining to services, products, or marketing statements (for example: It's Green Thinking™) are owned or licensed by Chauvet.

Art-Net™ is designed and copyrighted by Artistic Licence Holdings Ltd.

Any other product names, logos, brands, company names, and other trademarks featured or referred to within this document are the property of their respective trademark holders.

Copyright Notice Chauvet owns the content of this User Manual in its entirety, including but not limited to pictures, logos, trademarks, and resources.

© **Copyright 2014 Chauvet. All rights reserved.**

Electronically published by Chauvet in the United States of America.

Manual Use Chauvet authorizes its customers to download and print this manual for professional information purposes only. Chauvet expressly prohibits the usage, copy, storage, distribution, modification, or printing of this manual or its content for any other purpose without written consent from Chauvet.

Document Printing For better results, print this document in color, on letter size paper (8.5 x 11 in), double-sided. If using A4 paper (210 x 297 mm), configure your printer to scale the content accordingly.

Intended Audience Any person in charge of installing, operating, and/or maintaining this product should completely read through the guide that shipped with the product, as well as this manual, before installing, operating, or maintaining this product.

Disclaimer Chauvet believes that the information contained in this manual is accurate in all respects. However, Chauvet assumes no responsibility for any errors or omissions in this document. Chauvet reserves the right to revise and make changes to the content of this document without obligation that Chauvet notify any person or company of such revision or changes. In any way, this does not constitute a commitment by Chauvet to make such changes. Chauvet may issue a revision of this manual or a new edition to incorporate such changes.

Author	Date	Editor	Date
L. Henry	7/23/14	D. Coupe	1/27/15

Table of Contents

1. Before You Begin	3
What Is Included.....	3
Claims.....	3
Manual Conventions.....	3
Symbols.....	3
Safety Notes.....	4
Expected LED Lifespan.....	4
2. Introduction	5
Description.....	5
Features.....	5
Overview.....	6
Dimensions.....	7
Pixel Layout.....	7
3. Setup	8
AC Power.....	8
AC Plug.....	8
Fuse Replacement.....	8
Power Linking.....	9
Power Linking Diagram.....	9
DMX Linking.....	10
DMX Linking Diagram.....	10
DMX Mode.....	10
Master/Slave Mode.....	11
Ethernet Connections.....	11
Ethernet Connections Diagram.....	11
Kling-Net Mode.....	12
Art-Net™ Mode.....	12
Setting Modes And Protocols.....	12
Mounting.....	13
Orientation.....	13
Rigging.....	13
Mounting Diagram.....	14
4. Operation	15
Control Panel.....	15
Menu Map.....	16
Menu Operations.....	17
Auto Show.....	17
Exiting Auto Show Mode.....	17
Static Color.....	17
Dimmer Mode.....	17
Display Backlight.....	17
Product.....	18
Information.....	18
DMX Channel.....	18
DMX Address.....	18
Master/Slave.....	18
White Calibration.....	19
Fan Control.....	19
Temperature.....	19
Reset to Factory Default.....	19
Setting Ethernet Protocols.....	19

Kling-Net	19
Art-Net™	20
Kling-Net Mapper.....	21
Part 1: Confirm Network Connectivity	21
The Connected Devices Window	22
Part 2: Test Network Connectivity.....	22
Part 3: Map The Products For ArKaos.....	23
Nexus Software Upgrade Instructions	24
DMX Channel Assignments And Values	28
53-Channel.....	28
48-Channel.....	31
9-Channel.....	32
5-Channel.....	33
3-Channel.....	33
5. Technical Information	34
Product Maintenance.....	34
Returns	34
6. Technical Specifications.....	35
Contact Us	36

1. Before You Begin

What Is Included

- Nexus™ 4x4
- Neutrik® powerCON® power cord
- #5 Allen key with handle
- Warranty Card
- Quick Reference Guide

Claims

Carefully unpack the product immediately, and check the box to make sure all the parts are in the package and are in good condition.



If the box or the product and included accessories appear damaged from shipping or show signs of mishandling, notify the carrier immediately, not Chauvet. Failure to report damage to the carrier immediately may invalidate your claim. In addition, keep the box and contents for inspection.

For other issues, such as missing components or parts, damage not related to shipping, or concealed damage, file a claim with Chauvet within 7 days of delivery.

Manual Conventions

Convention	Meaning
1–512	A range of values in the text
50/60	A set of mutually exclusive values in the text
<SET>	A button on the product's control panel
Settings	A product function or a menu option
MENU>Settings	A sequence of menu options
1–10	A range of menu values from which to choose in a menu
Yes/No	A set of two mutually exclusive menu options in a menu
ON	A unique value to be entered or selected in a menu

Symbols

Symbols	Meaning
	Critical installation, configuration, or operation information. Failure to comply with this information may cause the product not to work, damage third-party equipment, or cause harm to the operator.
	Important installation or configuration information. Failure to comply with this information may keep the product from working.
	Useful information.

Safety Notes

Read all the following Safety Notes before working with this product. These notes include important information about the installation, usage, and maintenance of this product.



This product contains no user-serviceable parts. Any reference to servicing in this User Manual will only apply to properly trained Chauvet certified technicians. Do not open the housing or attempt any repairs.



All applicable local codes and regulations apply to proper installation of this product.

Personal Safety

- Avoid direct eye exposure to the light source while the product is on.
- Always disconnect this product from its power source before servicing.
- Always connect this product to a grounded circuit to avoid the risk of electrocution.
- Do not touch this product's housing during operation because it may be very hot.

Mounting and Rigging

- This product is for indoor use only! To prevent risk of fire or shock, do not expose this product to rain or moisture.
- Make sure there are no flammable materials close to this product while it is operating.
- When hanging this product, always secure to a fastening device using a safety cable.

Power and Wiring

- Always make sure you are connecting this product to the proper voltage in accordance with the specifications in this manual or on the product's specification label.
- Never connect this product to a dimmer pack or rheostat.
- Never disconnect this product by pulling or tugging on the power cable.

Operation

- Do not operate this product if you see damage on the housing, lenses, or cables. Have the damaged parts replaced by an authorized technician at once.
- Do not cover the ventilation slots when operating to avoid internal overheating.
- The maximum ambient temperature is 113 °F (45 °C). Do not operate this product at a higher temperature.
- In case of a serious operating problem, stop using this product immediately!
- To eliminate unnecessary wear and improve its lifespan, during periods of non-use completely disconnect the product from power via breaker or by unplugging it.



In the unlikely event that your CHAUVET® product requires service, contact Chauvet Technical Support.

Expected LED Lifespan

LEDs gradually decline in brightness over time, mostly because of heat. LEDs packaged in clusters exhibit higher operating temperatures than single LEDs. Using clustered LEDs at their fullest intensity significantly reduces the LEDs' lifespan, which under normal circumstances 40,000 to 50,000 hours. If extending this lifespan is vital, lower the operating temperature by improving the ventilation around the product and reducing the ambient temperature to an optimal operating range. In addition, limiting the overall projection intensity may also help to extend the LEDs' lifespan.

2. Introduction

Description Nexus™ 4x4 is a tour-ready wash light with a pixel mappable display of sixteen 27 watt RGB COB LEDs. The combination of circuit on board (COB) emitters and a clever reflector design create a soft, bright light with saturated hues. The Nexus™ 4x4 operates in Standalone mode or with the Art-Net™, Kling-Net, or DMX protocols. The Nexus™ 4x4s have coffin locks so they can be connected into large arrays.

- Features**
- Sixteen 27 watt RBG COB LEDs
 - Pixel mapping capability
 - Operates in Standalone and Master/Slave modes
 - Operates with Art-Net™, Kling-Net, or DMX protocols using 3-, 5-, 9-, 48- or 53-channel DMX personalities
 - Coffin locks for connecting into arrays
 - Works seamlessly with Nexus™ 4x1 and Nexus™ 2x2
 - Universal power and control cabling with Neutrik® powerCON®, Neutrik® etherCON®, and both 3- and 5-pin DMX ports

Overview

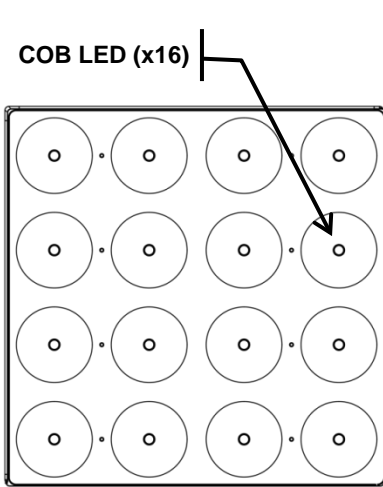

Front View

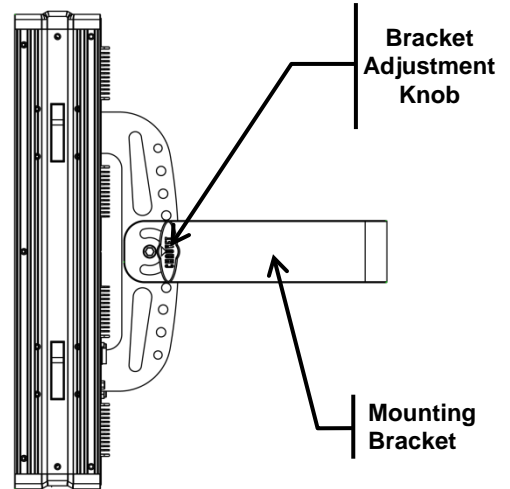

Side View

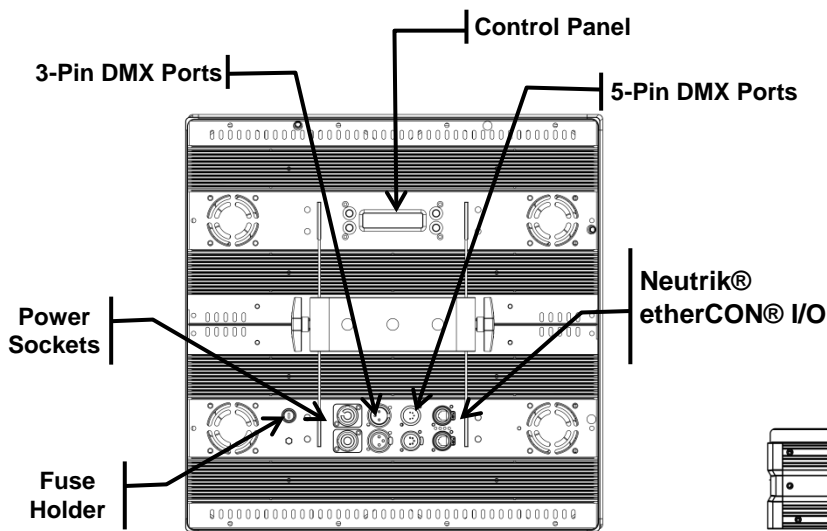

Rear View

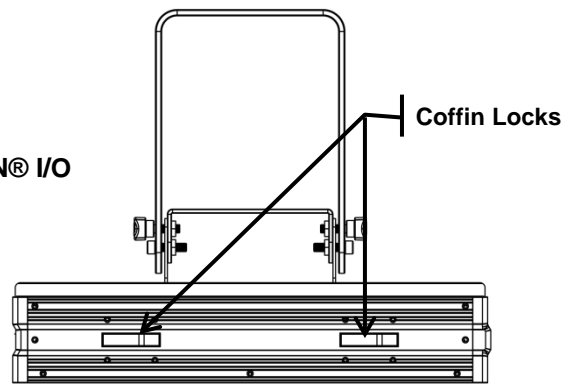

Top View

Dimensions

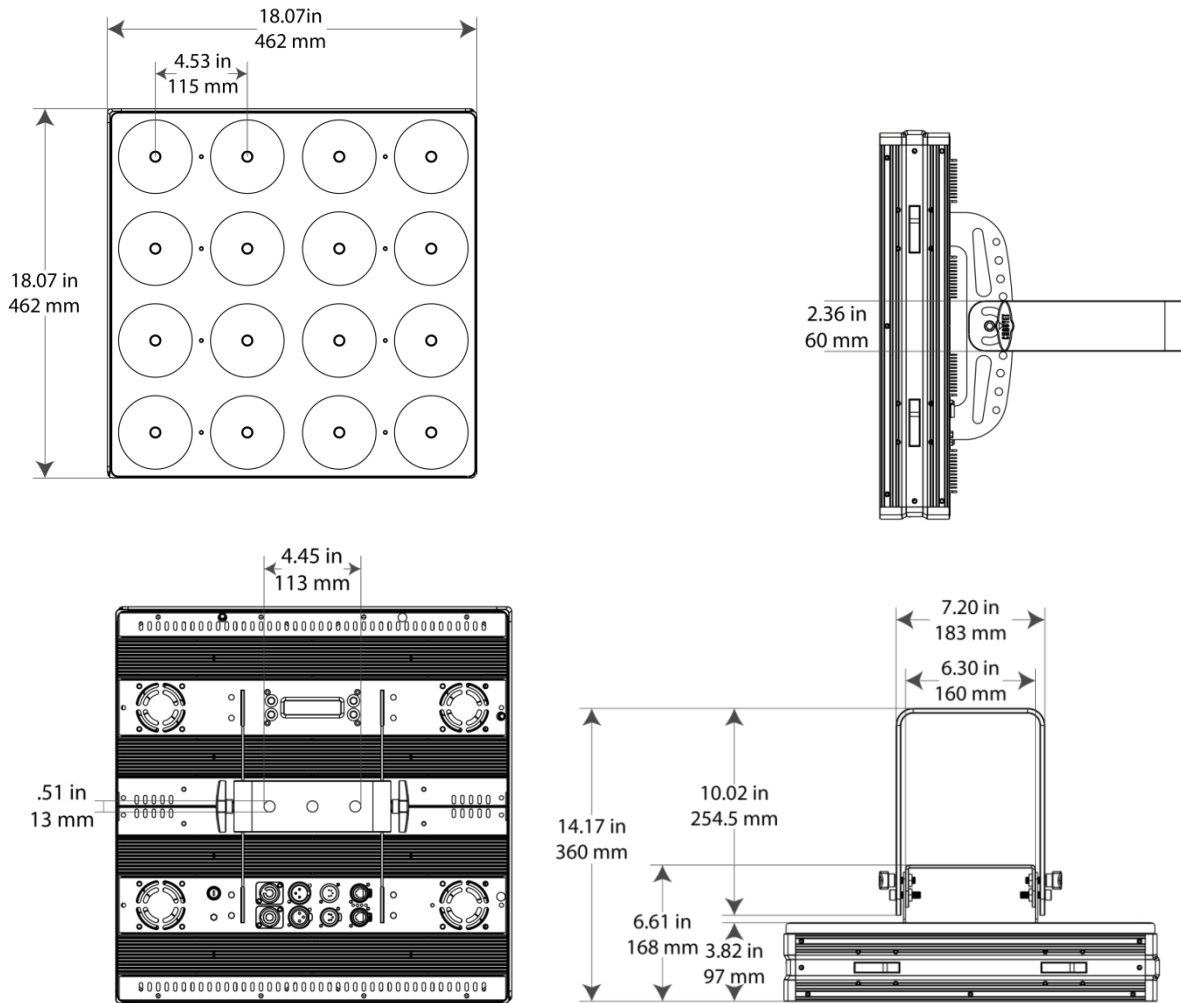

Pixel Layout

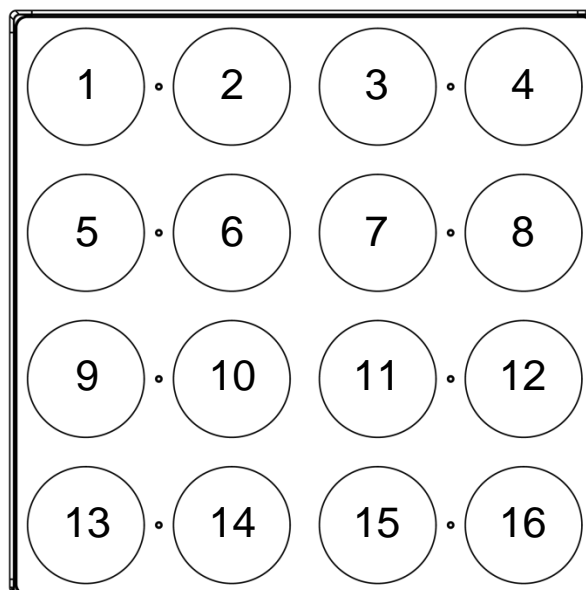

3. Setup

AC Power

The Nexus™ 4x4 has an auto-ranging power supply that works with an input voltage range of 100 to 240 VAC, 50/60 Hz. To determine the power requirements for the Nexus™ 4x4, refer to the label on the product or [Technical Specifications](#) in this manual.

The listed current rating indicates the maximum current draw during normal operation. For more information, download Sizing Circuit Breakers from the Chauvet website at www.chauvetprofessional.com.



- **Always connect this product to a protected circuit with an appropriate electrical ground.**
- **Never connect this product to a rheostat (variable resistor) or dimmer circuit, even if the rheostat or dimmer channel serves only as a 0 to 100% switch.**

AC Plug

The Nexus™ 4x4 comes with a power input cord terminated with a Neutrik® powerCON® connector on one end and an Edison plug on the other end (U.S. market). If the power input cord that came with the Nexus™ 4x4 product has no plug or there is the need to change the plug, use the table below to wire a new plug.

Connection	Wire (U.S.)	Wire (Europe)	Screw Color
AC Live	Black	Brown	Yellow or Brass
AC Neutral	White	Blue	Silver
AC Ground	Green/Yellow	Green/Yellow	Green

Fuse Replacement

The fuse is a T 5 A, 250 V and it is located in a fuse holder next to the Neutrik® powerCON® power socket. To replace the fuse, do the following:

1. Disconnect the product from power.
2. Using a flat-head screwdriver, unscrew the fuse holder cap.
3. Remove the blown fuse and replace it with a good fuse of the same type and rating.
4. Screw the fuse holder cap back in place.
5. Reconnect the product to power.



- **Make sure to disconnect the power before replacing a blown fuse.**
- **Always replace the blown fuse with a fuse of the same type and rating.**

Power Linking

The Nexus™ 4x4 supports power linking of up to:

- 4 products at 120 V,
- 7 products at 208 V, or
- 8 products at 230 V.

A power cord is included but power-linking cables are not included. For power-linking cables, see the Chauvet website at www.chauvetlighting.com.

Power Linking Diagram

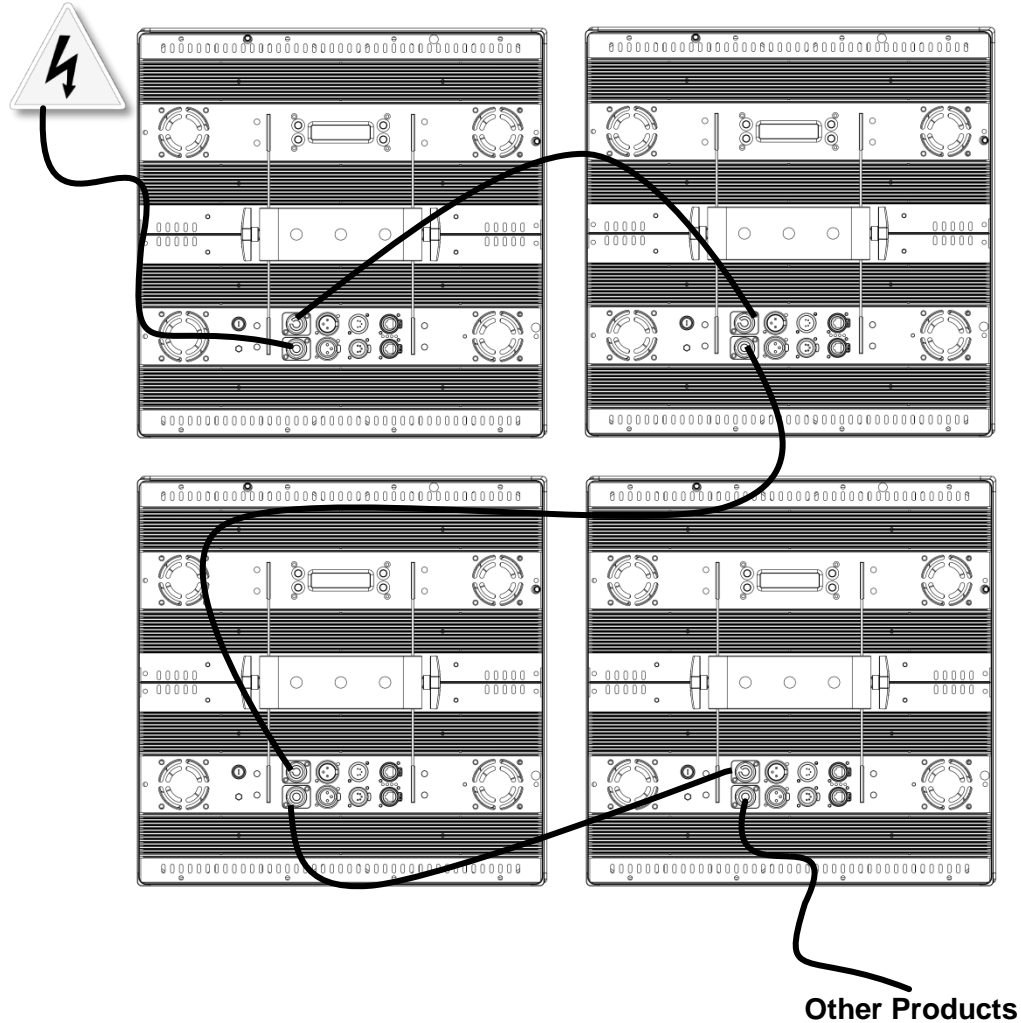

DMX Linking

DMX linking connects Nexus™ 4x4 products through their DMX In and Out ports. Nexus™ 4x4 has both 3- and 5-pin DMX ports, so either 3- or 5-pin cables, or a combination of both, can be used. DMX linking is for DMX control and for Master/Slave control.

DMX Controller or Master

DMX Linking Diagram

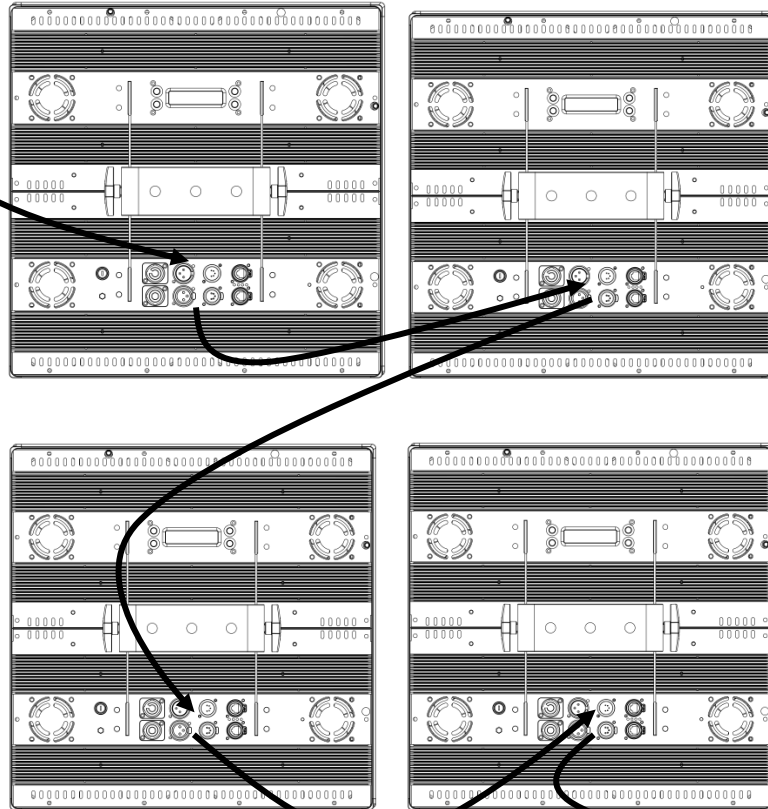

Other DMX Products

DMX Mode

In DMX mode, Nexus™ 4x4 products are controlled by a DMX controller, and the DMX address and DMX personality must be set through the control panel.

The Nexus™ 4x4 automatically senses its control source. When there is a DMX cable plugged in, the Nexus™ 4x4 responds to DMX control. When there is a Neutrik® etherCON® cable plugged in, it responds to an IP protocol, such as Art-Net™ or Kling-Net.

The Nexus™ 4x4 has 5 DMX personalities, each with different capabilities. The table below lists the capabilities of each personality. For more information, see [DMX Address](#) and [DMX Personality](#).

Personality	Capabilities
3-channel	RGB control
5-channel	RGB control with dimmer and strobe
9-channel	R, G, B, WW, CW control with dimmer and dimmer speed, strobe, color macros, auto programs and program speed
48-channel	RGB with individual pixel control
53-channel	R, G, B, control with 8 WW and 8 CW controls, dimmer and dimmer speed, strobe, color macros, auto programs and program speed

Master/Slave Mode

In Master/Slave mode one Nexus™ 4x4 product (the master) controls one or more Nexus™ 4x4 products (the slaves) without a DMX controller. The master Nexus™ 4x4 is set to an auto program, static color, or color macro and sends DMX signals to the slaves. During Master/Slave operation, the slave products operate in unison with the master. For more information, see [Master/Slave](#).



- **Do not connect a DMX controller to the DMX chain when operating Nexus™ 4x4 products in Master/Slave mode, because signals from the master and the DMX controller will conflict and cause erratic behavior in all the products.**
- **Master/Slave operates via DMX ports only. The Neutrik® etherCON® ports cannot be used for Master/Slave mode.**



For more information about DMX, see the CHAUVET® DMX primer, available at www.chauvetlighting.com.

Ethernet Connections

Ethernet connections link Nexus™ 4x4 to routers and each other through their Neutrik® etherCON® ports. Ethernet connections are for running TCP/IP-based control system, such as Art-Net™ and Kling-Net. All Neutrik® etherCON® ports can be either input or output ports, and panels can be linked together, but the start of each chain must be a router port.



Do not connect Nexus™ 4x4 to the WAN port of the router.

Ethernet Connections Diagram

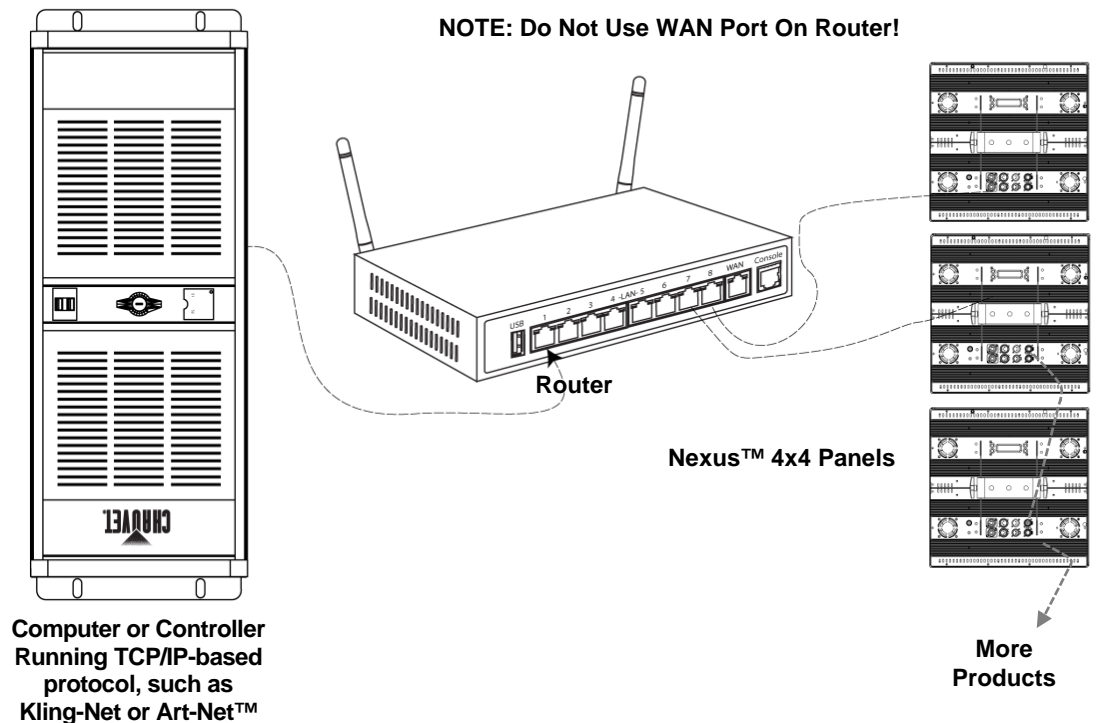

Kling-Net Mode

Kling-Net is a network protocol that uses TCP/IP to send DMX over a network and into the Neutrik® etherCON® connection ports of the Nexus™ 4x4 panels. Kling-Net works seamlessly with Kling-Net-supported ArKaos software for configuring and mapping display devices. For more information, see [Kling-Net Configuration](#).



Kling-Net requires a gigabit per second (1,000 Mbps) Ethernet card and network router.

Art-Net™ Mode

Art-Net™ is an Ethernet protocol that uses TCP/IP to send DMX signals over a network and into the Neutrik® etherCON® connection ports of the Nexus™ 4x4 panels. Art-Net™ requires configuration through the control panel. For more information, see [Setting Ethernet Protocols](#) and [Art-Net™](#).

For more information about Art-Net™, see the Art-Net™ protocol document available on the Chauvet website at www.chauvetlighting.com.



Nexus™ 4x4 panels do not work with Art-Net™ controllers sending in Broadcast mode. For information about the controller's mode, see the controller's User Manual.

Setting Modes And Protocols

The Nexus™ 4x4 automatically senses whether control is coming from a DMX source or a Network source. When there is a Neutrik® etherCON® cable plugged into it, the Nexus™ 4x4 responds to a TCP/IP protocol, such as Art-Net™ or Kling-Net, depending on the setting in the control panel. If there is a DMX cable plugged into it, the Nexus™ 4x4 responds to a DMX controller or Master/Slave control, depending on the settings in the control panel.

The Nexus™ 4x4 can receive control from only one set of ports, either the DMX ports or the Neutrik® etherCON® ports. The Nexus™ 4x4 senses which ports are used on power-up, so the panel cannot be changed from DMX to TCP/IP, or from TCP/IP to DMX while it is turned on.

To switch from one set of ports to another (one control type to another):

1. Disconnect the Nexus™ 4x4 from power.
2. Switch the control cables.
3. Reconnect the Nexus™ 4x4 to power.

A DMX personality must be set for all control modes – DMX, Art-Net™, or Kling-Net. For more information, see [DMX Personality](#).

Kling-Net has no settings to configure, but it must be selected through the control panel. For more information, see [Setting Ethernet Protocols](#) and [Kling-Net](#).

Art-Net™ has a number of settings that must be configured through the control panel. For more information, see [Setting Ethernet Protocols](#) and [Art-Net™](#).

Mounting

Before mounting the Nexus™ 4x4, review the Safety Notes section. Read and follow the guidelines below for mounting the Nexus™ 4x4.

- When selecting a desired location and before installation, consider easy access to this product for operation, programming adjustments, and routine maintenance.
- Mount in a way that allows adequate ventilation around the product.
- Do not mount near flammable materials as indicated in the [Safety Notes](#) section.
- Do not mount where there is rain, high humidity, or extreme temperature change.
- Make sure that the mounting structure can support the weight of the Nexus™ 4x4. See [Technical Specifications](#) for information on weight.
- Always secure product to a fastening device using a safety cable.

Orientation

The Nexus™ 4x4 can be mounted in any orientation as long as each individual product is secured through the mounting bracket. Always mount the Nexus™ 4x4 securely and use safety cables.

Rigging

The Nexus™ 4x4 includes a hanging bracket with holes for M12-compatible bolts. There are coffin locks on all four edges of the Nexus™ 4x4 that are used for aligning the products in an array. The coffin locks should not carry the weight of the Nexus™ 4x4. Each Nexus™ 4x4 must be rigged to hold its own weight using its hanging bracket and at least one rigging point per panel.



The coffin locks of the Nexus™ 4x4 panels are not load-bearing connectors.

The hanging bracket can be bolted directly onto a surface or can be connected to truss with clamps. For the complete line of CHAUVET® clamps, see the Chauvet website at www.trusst.com/productcategory/accessories-clamps/.

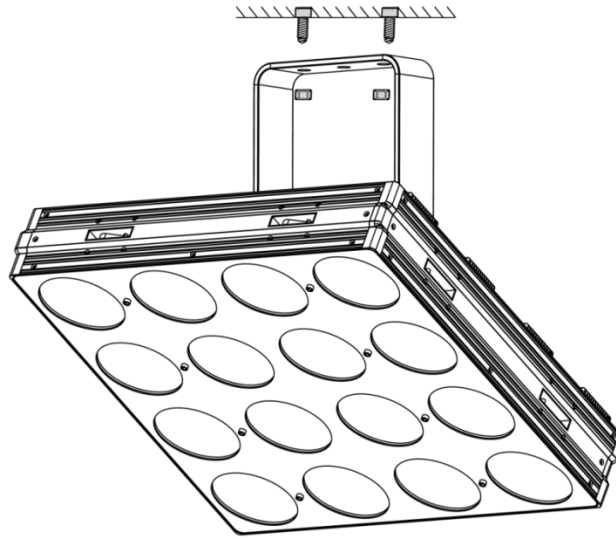

Top Mount To Structure

Mounting Diagram

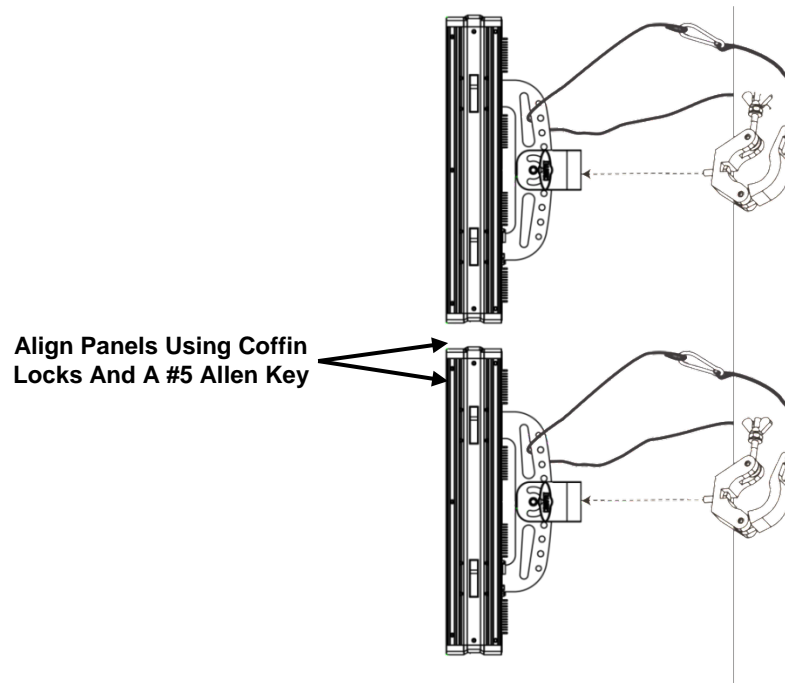

Align Panels Using Coffin Locks And A #5 Allen Key

Side Mount To Pipe Or Truss



Only use the coffin locks to align the Nexus™ 4x4s. The coffin locks are not load-bearing connectors. Do not hang the product by the coffin locks.

4. Operation

Control Panel

Button	Function
<MENU>	Scrolls through the main menu or exits from the current menu or function
<ENTER>	Enables the currently displayed menu or sets the currently selected value in to the current function
<UP>	Navigates upward through the menu list or increases the numeric value when in a function
<DOWN>	Navigates downward through the menu list or decreases the numeric value when in a function

To access a main level menu press <MENU> repeatedly, or press <MENU> once and then <UP> or <DOWN>, until the desired menu level shows on the control panel display. Press <ENTER> to go into that menu level.

To select a programming value in the selected main level menu, press <UP> or <DOWN> until the desired option shows on the control panel display. Press <ENTER> to select the option.

To exit back to the home screen, press and hold <MENU> for 10 seconds.

The home screen on the control panel display shows <Master> if the Nexus™ 4x4 is in a standalone or Master mode.

The following [Menu Map](#) shows the main levels and the programming levels for each option.



- **For Ethernet Settings, <MENU> must be pressed twice to change between Art-Net™ and Kling-Net.**
- **Changes to the settings are activated when the control panel display returns to the home screen. To return the control panel display to the home screen, press and hold <MENU> for 10 seconds.**

After pressing <MENU> once, use <UP> or <DOWN> to cycle through main level options.

Menu Map

Main Level	Programming Levels		Description		
Auto Show	Auto 1–9	Show Speed 000–100	Selects auto programs and speed control		
	Fade 1–2		Selects color fades 1–2 and speed control		
Static	Fixture Color	R	Selects a preset color		
		G			
		B			
		GB			
		RB			
		RG			
	RGB				
Manual Color	R	000–255	Sets color levels for manual color mixing		
	G				
	B				
Dimmer Mode	Off		Sets dimming curve		
	Dimmer 1–3				
Back Lite	On		Sets control panel backlight on time		
	10S				
	20S				
	30S				
Info	Fixture Hours		Shows total operating time		
	Version		Shows software version		
	IP Address		Shows IP address		
	Device ID		Shows ID number		
DMX Address	001–512		Sets DMX starting address		
DMX Channel	3Ch		Sets DMX personality for DMX, Art-Net™ mode, and Kling-Net mode.		
	5Ch				
	9Ch				
	48Ch				
	53Ch				
Master/Slave	Master		Sets Master mode		
	Slave		Sets Slave mode		
White	R	125–255	Sets the color mix that will be white		
	G				
	B				
Fan Speed	Auto		Sets fan to slow down when product is cool		
	High		Sets fan to run continuously at high speed		
Temperature			Shows product's internal temperature		
Ethernet Settings	Protocol	Kling-Net		Sets Kling-Net protocol	
		Art-Net	IP Mode	Manual	Sets product to use a manually set IP address
				DHCP	Sets product to use dynamic IP addressing
				Static	Sets product to use its internal IP address
		Net	000–127	Sets the net address of the product	
		Subnet	00–15	Sets the subnet number of the product	
		Universe		Sets the universe number of the product	

Menu Operations

The menu operations set configurations for the Nexus™ 4x4, including built-in programs to operate the Nexus™ 4x4 without a DMX controller. The menu operations are accessed via the control panel. See [Control Panel](#).



Changes to settings are not activated until the control panel display returns to the home screen. To return the control panel display to the home screen, press and hold <MENU> for 10 seconds.

Auto Show

Auto Show mode allows for dynamic RGB color mixing without a DMX controller. To activate Auto Show mode do the following:

1. Go to the **Auto Show** main level.
2. Select the Auto (**1–12**) or Fade program.
3. Select the Show Speed (**000–100**).
4. Press **<MENU>** to return to the home screen.

Exiting Auto Show Mode

Auto Show mode does not stop when a different operating mode, such as DMX, Art-Net™, or Kling-Net is selected. To exit from Show mode, put the Nexus™ 4x4 into Slave mode. For more information see [Master/Slave Mode](#). Slave mode does stop when a different operating mode is selected through the control panel.

Static Color

Static mode selects preset colors or color mixing. To set Static mode do the following:

1. Go to the **Static** main level.
2. Select **Fixture Color** or **Manual Color**.

For **Fixture Color**:

1. Select desired color (**R, G, B, GB, RB, RG, or RGB**).
2. Press **<MENU>** to return to the home screen.

For **Manual Color**:

1. Select the desired color (**R, G, or B**).
2. Select the desired color value (**000–255**).
3. Repeat the steps for each color.
4. Press **<MENU>** to return to the home screen.

Dimmer Mode

Dimmer Mode configures the rate of change in light intensity. There are 3 different dimmer modes with **1** being the slowest and **3** being the fastest. When Dimmer Mode is set to **OFF**, the Nexus™ 4x4 fades in direct proportion to the DMX values. To configure Dimmer Mode, do the following: Go to Dimmer Mode in the main level.

1. Select a dimmer mode (**OFF, Dimmer 1, Dimmer 2, or Dimmer 3**).
2. Press **<MENU>** to return to the home screen.

Display Backlight

Back Lite option determines how long the control panel display stays on during inactivity. To set the display backlight time, do the following:

1. Go to **Back Lite** in the main level.
2. Select the desired amount of time (in seconds) the backlight display will stay on after pressing the last menu button (**On, 10S, 20S, or 30S**).
3. Press **<MENU>** to return to the home screen.

Product Information

Product Information shows information about the Nexus™ 4x4. To display product information, do the following:

1. Select the desired program level based on the information required.
 - **Fixture Hours** – The amount of time the product has been in use
 - **Version** – The software version installed on the product
 - **IP Address** - The product's IP address
 - **Device ID** - The product's ID number (used with Kling-Net only)
2. Press **<MENU>** to return to the home screen.

DMX Channel

DMX Channel sets the Nexus™ 4x4 DMX personality for use in all modes: DMX, Art-Net™, and Kling-Net. Each DMX personality has different capabilities. For more information, see [DMX Mode](#). To select a DMX personality, do the following:

1. Go to the **DMX Channel** main level.
2. Select the desired personality (**3Ch**, **5Ch**, **9Ch**, **48Ch**, or **53Ch**).
3. Press **<MENU>** to return to the home screen.

DMX Address

DMX Address sets the Nexus™ 4x4 DMX starting address for DMX mode and Art-Net™ mode. To select a DMX address, do the following:

1. Go to **DMX Address** main level.
2. Select the starting address (**001–512**).
3. Press **<MENU>** to return to the home screen.

The highest recommended DMX address for each DMX personality is listed in the table below.

DMX Personality	Highest DMX Address	DMX Personality	Highest DMX Address
3Ch	510	48Ch	465
5Ch	508	53Ch	460
9Ch	504		

Master/Slave

Master/Slave mode configures the Nexus™ 4x4 panels so that a group of panels (the slaves) duplicates the actions of a single panel (the master). Master/Slave mode does not need a DMX controller. To configure the Nexus™ 4x4s for Master/Slave mode, do the following:

First, set each of the slave panels:

1. Go to the **Master/Slave** main level.
2. Select **Slave**.
3. Press **<MENU>** to return to the home screen.

Second, set the master panel:

1. Go to the **Master/Slave** main level.
2. Select **Master**.
3. Select a standalone mode (an automatic program or a static mode). For more information, see [Auto Show](#) and [Static Colors](#).
4. Press **<MENU>** to return to the home screen.

- **Set the slaves before setting the master.**
- **Do not connect a DMX controller to Nexus™ 4x4 products configured for Master/Slave operation. The DMX controller may interfere with signals from the master.**
- **The master must be the first product in the DMX daisy chain.**
- **The master must be set to a standalone mode for Master/Slave to work.**



White Calibration

White Calibration sets the color temperature of the white produced when the DMX values of red, green, and blue are at **255**. To set the color temperature for white calibration, do the following:

1. Go to the **White** main level.
2. Select the desired color (**R**, **G**, or **B**).
3. Select the desired color value (**125–255**).
4. Repeat the steps for each color.

Fan Control

Fan Control sets the fan for high or automatic operation. To select the fan speed, do the following:

1. Go to the **Fan Speed** main level.
2. Select the desired speed **High** (fan runs continuously) or **Auto** (fan stops when the panel is cool).

Temperature

Temperature shows the internal temperature of the Nexus™ 4x4. To show the internal temperature, do the following:

1. Go to the **Temperature** main level.

Reset to Factory Default

This procedure resets the Nexus™ 4x4 to the default factory values:

1. Disconnect the Nexus™ 4x4 from power.
2. Press and hold **<MENU>** and **<ENTER>** simultaneously.
3. Reconnect the Nexus™ 4x4 to power.
4. Release **<MENU>** and **<ENTER>** when **Factory reset? ENTER = Confirm** shows on the display.
5. Press **<ENTER>**.
6. Wait for the reset process to finish.

Setting Ethernet Protocols

Nexus™ 4x4 products run on Kling-Net or Art-Net™.

The Kling-Net protocol requires no configuration through the Nexus™ 4x4 menu, except to set the panel to Kling-Net. All Ethernet configurations in the Kling-Net protocol are done through ArKaos software. The Art-Net™ protocol requires Ethernet configuration through the Nexus™ 4x4 menu.

Kling-Net

To set the Nexus™ 4x4 to Kling-Net, do the following:

1. Press **<MENU>** and then **<DOWN>** until **Ethernet Settings** shows in the display.
2. Press **<ENTER>**.
 - If **<Kling-Net>** shows in the display, do the following:
 - a) Press **<MENU>** until display returns to the home screen.
 - If **<Art-Net>** shows in the display, do the following:
 - a) Press **<ENTER>**. The words **<Art-Net>** start blinking.
 - b) Use **<UP>** or **<DOWN>**. **<Kling-Net>** shows and is blinking.
 - c) Press **<ENTER>** and **<Kling-Net>** stops blinking.
 - d) Press **<MENU>** until display returns to the home screen.

The Kling-Net protocol is now set.

Art-Net™ To set the Nexus™ 4x4 to Art-Net™, do the following:

1. Press **<MENU>** and then **<DOWN>** until **Ethernet Settings** shows in the display.
2. Press **<ENTER>**.
3. If **<Art-Net>** shows in the display, the Art-Net™ protocol is set. Go to Step 7 below to configure Art-Net™ settings.

If **<Kling-Net>** shows in the display, do the following:

4. Press **<ENTER>** and **<Kling-Net>** starts blinking.
5. Use **<UP>** or **<DOWN>** until **<Art-Net>** shows and blinks.
6. Press **<ENTER>** and **<Art-Net>** stops blinking.

The Art-Net™ protocol is now set.

Once the Nexus™ 4x4 is set to Art-Net™, do the following:

7. Press **<DOWN>**. **Universe < xx>** shows.
8. Press **<ENTER>** and **< xx>** starts blinking.
9. Use **<UP>** or **<DOWN>** until the desired universe number (**0–15**) shows.
10. Press **<ENTER>** to select the universe number and **< xx>** stops blinking.
11. Press **<DOWN>**. **Subnet < xx>** shows.
12. Press **<ENTER>** and **< xx>** starts blinking.
13. Use **<UP>** or **<DOWN>** until the desired subnet number (**0–15**) shows.
14. Press **<ENTER>** to select the subnet number and **< xx>** stops blinking.
15. Press **<DOWN>**. **Net < xx>** shows.
16. Press **<ENTER>** and **< xx>** starts blinking.
17. Use **<UP>** or **<DOWN>** until the desired net number (**0–127**) shows.
18. Press **<ENTER>** to select the net number and **< xx>** stops blinking.
19. Press **<DOWN>**. **IP Mode < xxxxx>** shows.
20. Press **<ENTER>** the **< xxxxx>** starts blinking.
21. Use **<UP>** or **<DOWN>** to cycle through the IP mode options **<Manual>**, **<Static>**, or **<DCHP>**.
22. Press **<ENTER>** to select the desired IP mode.

If **<Manual>** IP mode is selected, the IP Address shows. To set the manual IP address, do the following:

1. Press **<ENTER>** to move between IP address octets.
2. Press **<UP>** and **<DOWN>** to set the numbers within each IP address octet.
3. Press **<MENU>** to confirm the IP address.



After pressing **<MENU>** once, use **<UP>** or **<DOWN>** to cycle through top-level options.

Kling-Net Mapper

Kling-Net Mapper is part of the ArKaos software package and is used to inform the ArKaos software about the layout of the Nexus™ 4x4 panels. This process is called mapping. Kling-Net Mapper and ArKaos software can be run simultaneously allowing the operator to see immediately the effects of the mapping on the live presentation. However, Kling-Net Mapper does not need to be active for ArKaos software to work. For more information, see ArKaos manuals at <http://arkaospro.com>.

Part 1: Confirm Network Connectivity

The following section provides step-by-step instructions for mapping the Nexus™ 4x4 panels and informing ArKaos software of the mapping.

1. Connect the ArKaos computer and Nexus™ 4x4s to the same network. For more information, see [Art-Net™/Kling-Net Connection Diagram](#).
2. Set the all the Nexus™ 4x4s to Kling-Net operating mode. For more information, see [Setting Ethernet Protocols](#).
3. Open the ArKaos Kling-Net Mapper. All the Kling-Net devices populate a list on the left side of the screen in the Connected Devices window.

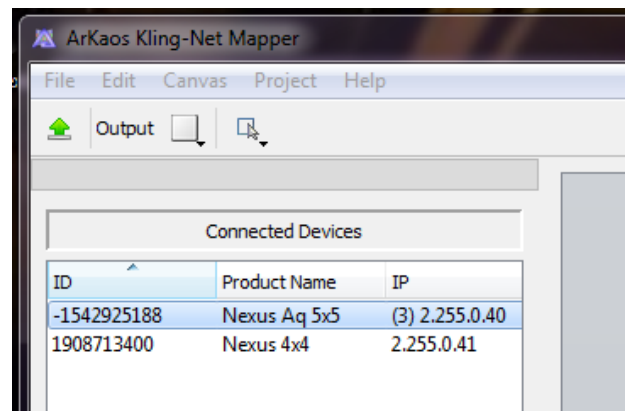

The Connected Devices Window

It can take up to 20 seconds for all the products to populate the list. The devices display in different colors for different reasons, which are as follows:

Colors and Activity	Explanation
Black with an ID number and IP address	There is connectivity and everything is working properly, but the device is not yet mapped.
Green with an ID number and IP address	There is connectivity and everything is working properly, and the device is mapped.
Black to red with no IP address during initial population	The King-Net™ Mapper could not find an IP address for the device, most likely because the system is using an Ethernet switch instead of an Ethernet hub.
Black to red after initial population	The connectivity has been lost.

Part 2: Test Network Connectivity

4. Select the Output dropdown icon from the tool bar at the top of the Kling-Net Mapper screen. One of the options will be Test Pattern.

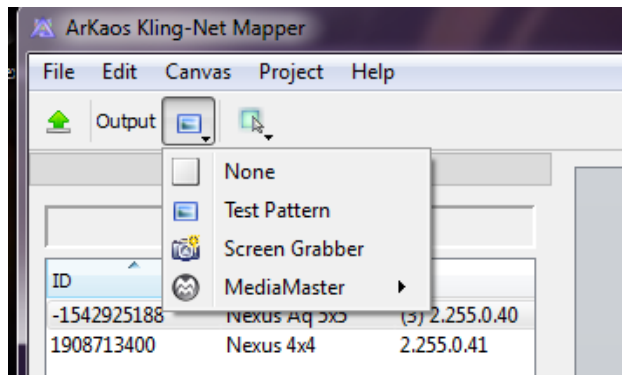

5. Select **Test Pattern**. The image to the right of the icon is a small screen, indicating that Test Pattern is the current mode.
6. Select the icon to the right of the Output dropdown icon. One of the options will be Flashing Output Selection.

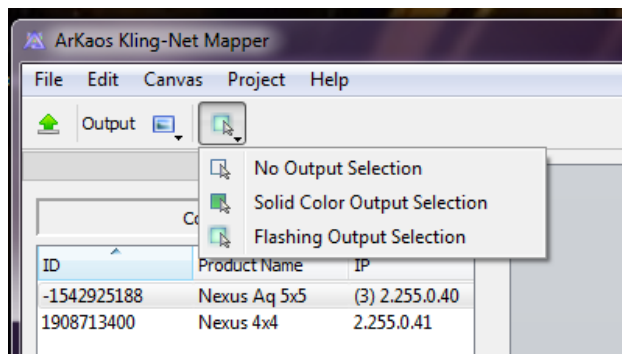

7. Select **Flashing Output Selection**. The icon is a faded green square with an arrow, indicating that a flashing green light is the current test pattern.
8. Left click once on an LED display product. The product flashes green.
9. Repeat Step 8 for every product in the list.

Part 3: Map The Products For ArKaos

10. Make sure the Nexus™ 4x4 products are all listed in the Connected Devices window and have flashed when tested. For more information, see [Part1 Confirming Connectivity](#).
11. Click on the first product in the list and drag it onto the mapping image in the center of the screen. A shape representing the display product shows on the mapping image. The product displays the pattern on the mapping image.

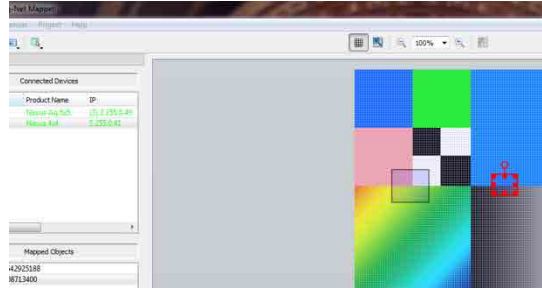

The red outline around the product on the mapping image indicates that the product is selected.

12. Drag, rotate, and resize the shape on the mapping image until it is in the position needed for the presentation layout.

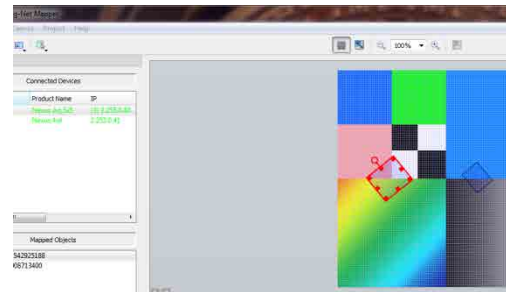

13. Repeat steps 11 thru 12 for every Nexus™ 4x4 product.
14. Complete Parts One and Two.
15. Click on **File** in the ArKaos Media Mapper.
16. Click on **Save As**.

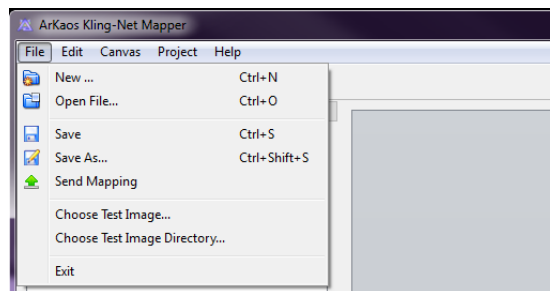

17. Save the file.



Remember the location of the file because the file must be loaded into the ArKaos software.

Nexus Software Upgrade Instructions

The following steps refer to the Windows® 7 operating system environment.

Step 1:

1. Connect the Nexus™ 4x4 to the router.
2. Verify the computer is using the same network as the Nexus™ 4x4 product.

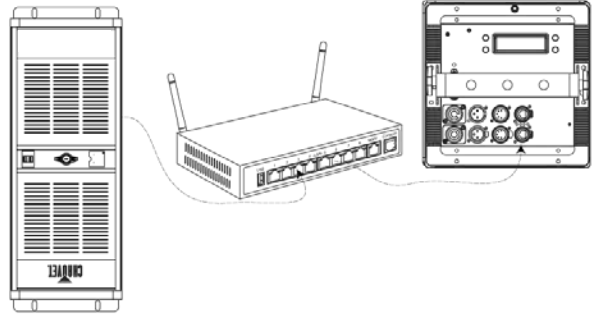

Step 2:

1. From the Nexus™ 4x4 main level, navigate to **Ethernet > Settings**.

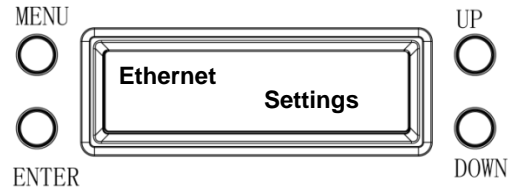

Step 3:

1. Select **Protocol**.
2. Select **<Art-Net>**.
3. Select **<Static>** IP Mode.

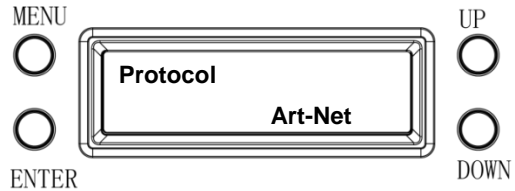

Step 4:

1. From the Windows® start menu, click the **<Start>** button.
2. From the Search box, type Network and Sharing Center. Windows will generate the search results in the Start window.
3. Select Network and Sharing Center, and the Network and Sharing Center dialog appears.

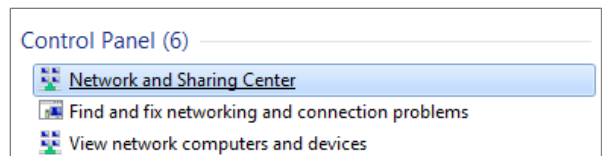

Step 5:

1. Select the desired network the product is connected to.

If you are running a hard-wired line from the PC to your router, then select Local Area Connection. The Local Area Connection Status dialog appears.

2. Click **Properties**. The Local Area Connection Properties dialog appears.

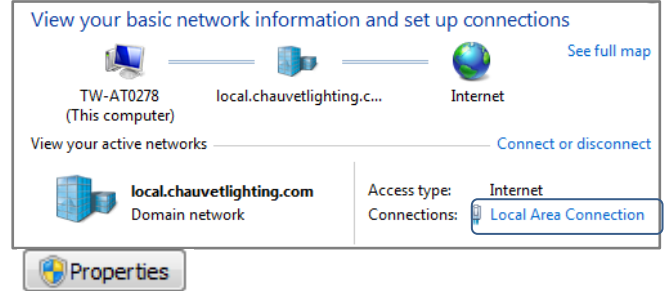

Step 6:

1. From the Networking tab, select Internet Protocol Version 4 (TCP/IPv4).
2. Click **Properties**. The Internet Protocol Version 4 (TCP/IPv4) Properties dialog appears.

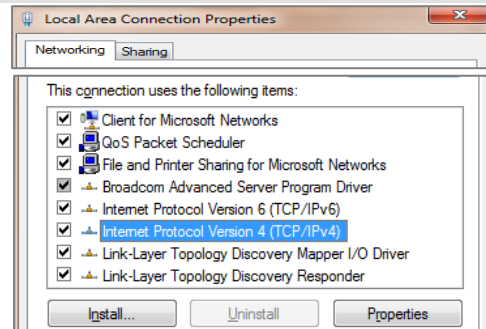

Step 7:

1. From the General tab, select **Use the following IP address:**.
2. Enter the following information:
3. Enter 2.255.0.0 in the IP address box.
4. Enter 255.0.0.0 in the Subnet mask box.
5. Click **OK**.
6. Close existing dialogs that are currently open.
7. Minimize the Control Panel, as it will be necessary to access this window after the software upgrade is uploaded to the product.

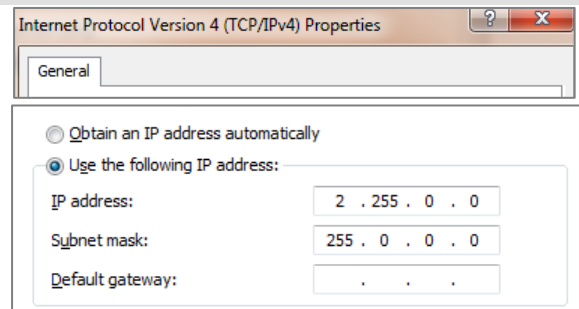

Step 8:

1. From the Nexus™ 4x4 control panel, navigate to the Info main level.
2. Select **IP Address**.
3. From the PC, open the Internet browser.
4. Enter the IP address for the Nexus™ 4x4 you are working with in the address bar. For example, if the IP address shown in the product's control panel is 2.34.58.104, then type that into your internet browser address bar.
5. Press **ENTER**. The Authentication Required dialog appears.

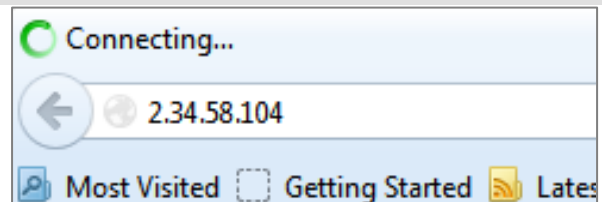

Step 9:

1. Enter the following information:
 - Enter **admin** in the User Name box.
 - Enter **admin** in the Password box.
2. Click **Log In**. The Nexus™ 4x4 firmware window appears.

If the user name/password you entered is invalid, follow the Factory Reset procedure.

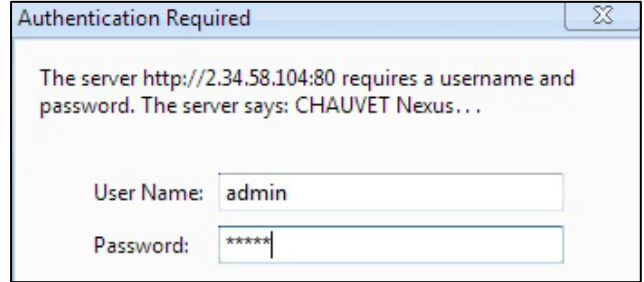

Step 10:

1. From the Navigation bar, select the Upgrade tab.
2. From the Firmware Upgrade section, click **Choose File**. The Open dialog appears.

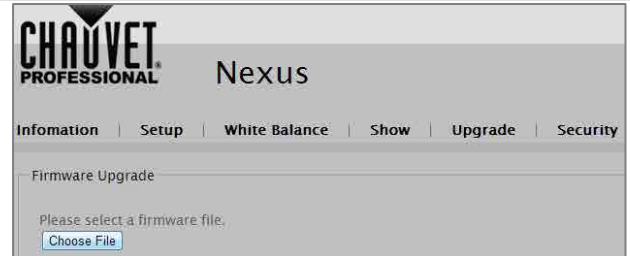

Step 11:

1. From the Open dialog, select the file to upload the firmware onto the Nexus™ 4x4 product.
2. Click **Open**.

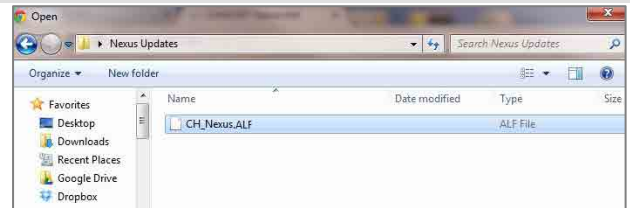

The **“Downloading...”** message appears in the product's control panel.

Once the firmware finishes downloading the software, the product will automatically reset the unit and the control panel flickers.

Do not turn off the product during the downloading process. It will take approximately 1 minute to reset.

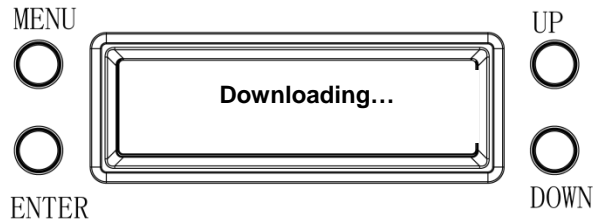

Step 12:

1. Go to the Info main level.
2. Select **Version**.
3. Verify the product's control panel displays the uploaded version.

The software upgrade is now complete.

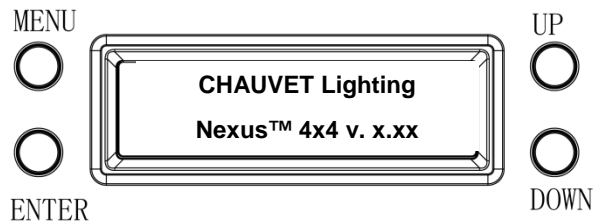

Step 13:

Once the software upgrade is complete, the IP setting on your PC needs to be changed back to the original settings.

1. Refer to Step 4 for navigation instructions on how to access the Internet Protocol Version 4 Properties (TCP/IPv4) dialog.
2. From the General tab, select **Obtain an IP address automatically**, and click **OK**.
3. Continue to close the dialogs displayed until you exit out of the Control Panel.

The installation process is complete.

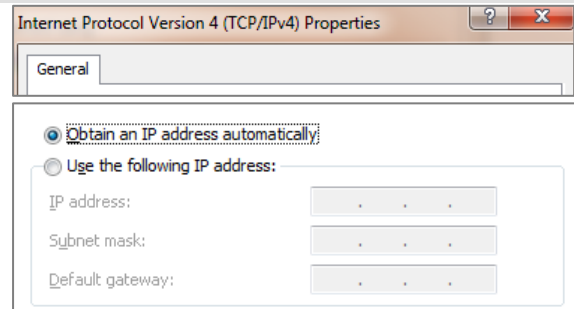

DMX Channel Assignments And Values

The following tables show the DMX channel function assignments and the values that trigger the functions.

53-Channel

53Ch	Channel	Function	Value	Percent/Setting
1		Red 1	000 ○ 255	0–100%
		Warm White 1		When values 011–020 in CH. 53 are activated
2		Green 1	000 ○ 255	0–100%
		Cool White 1		When values 011–020 in CH. 53 are activated
3		Blue 1	000 ○ 255	0–100%
4		Red 2	000 ○ 255	0–100%
		Warm White 2		When values 011–020 in CH. 53 are activated
5		Green 2	000 ○ 255	0–100%
		Cool White 2		When values 011–020 in CH. 53 are activated
6		Blue 2	000 ○ 255	0–100%
7		Red 3	000 ○ 255	0–100%
		Warm White 3		When values 011–020 in CH. 53 are activated
8		Green 3	000 ○ 255	0–100%
		Cool White 3		When values 011–020 in CH. 53 are activated
9		Blue 3	000 ○ 255	0–100%
10		Red 4	000 ○ 255	0–100%
		Warm White 4		When values 011–020 in CH. 53 are activated
11		Green 4	000 ○ 255	0–100%
		Cool White 4		When values 011–020 in CH. 53 are activated
12		Blue 4	000 ○ 255	0–100%
13		Red 5	000 ○ 255	0–100%
		Warm White 5		When values 011–020 in CH. 53 are activated
14		Green 5	000 ○ 255	0–100%
		Cool White 5		When values 011–020 in CH. 53 are activated
15		Blue 5	000 ○ 255	0–100%
16		Red 6	000 ○ 255	0–100%
		Warm White 6		When values 011–020 in CH. 53 are activated
17		Green 6	000 ○ 255	0–100%
		Cool White 6		When values 011–020 in CH. 53 are activated
18		Blue 6	000 ○ 255	0–100%
19		Red 7	000 ○ 255	0–100%
		Warm White 7		When values 011–020 in CH. 53 are activated
20		Green 7	000 ○ 255	0–100%
		Cool White 7		When values 011–020 in CH. 53 are activated
21		Blue 7	000 ○ 255	0–100%
22		Red 8	000 ○ 255	0–100%
		Warm White 8		When values 011–020 in CH. 53 are activated
23		Green 8	000 ○ 255	0–100%
		Cool White 8		When values 011–020 in CH. 53 are activated
24		Blue 8	000 ○ 255	0–100%

53Ch	Channel	Function	Value	Percent/Setting
25		Red 9	000 ◊ 255	0–100%
		Warm White 9		When values 011–020 in CH. 53 are activated
26		Green 9	000 ◊ 255	0–100%
		Cool White 9		When values 011–020 in CH. 53 are activated
27		Blue 9	000 ◊ 255	0–100%
28		Red 10	000 ◊ 255	0–100%
		Warm White 10		When values 011–020 in CH. 53 are activated
29		Green 10	000 ◊ 255	0–100%
		Cool White 10		When values 011–020 in CH. 53 are activated
30		Blue 10	000 ◊ 255	0–100%
31		Red 11	000 ◊ 255	0–100%
		Warm White 11		When values 011–020 in CH. 53 are activated
32		Green 11	000 ◊ 255	0–100%
		Cool White 11		When values 011–020 in CH. 53 are activated
33		Blue 11	000 ◊ 255	0–100%
34		Red 12	000 ◊ 255	0–100%
		Warm White 12		When values 011–020 in CH. 53 are activated
35		Green 12	000 ◊ 255	0–100%
		Cool White 12		When values 011–020 in CH. 53 are activated
36		Blue 12	000 ◊ 255	0–100%
37		Red 13	000 ◊ 255	0–100%
		Warm White 13		When values 011–020 in CH. 53 are activated
38		Green 13	000 ◊ 255	0–100%
		Cool White 13		When values 011–020 in CH. 53 are activated
39		Blue 13	000 ◊ 255	0–100%
40		Red 14	000 ◊ 255	0–100%
		Warm White 14		When values 011–020 in CH. 53 are activated
41		Green 14	000 ◊ 255	0–100%
		Cool White 14		When values 011–020 in CH. 53 are activated
42		Blue 14	000 ◊ 255	0–100%
43		Red 15	000 ◊ 255	0–100%
		Warm White 15		When values 011–020 in CH. 53 are activated
44		Green 15	000 ◊ 255	0–100%
		Cool White 15		When values 011–020 in CH. 53 are activated
45		Blue 15	000 ◊ 255	0–100%
46		Red 16	000 ◊ 255	0–100%
		Warm White 16		When values 011–020 in CH. 53 are activated
47		Green 16	000 ◊ 255	0–100%
		Cool White 16		When values 011–020 in CH. 53 are activated
48		Blue 16	000 ◊ 255	0–100%

53Ch	Channel	Function	Value	Percent/Setting
49	Auto Programs		000 ó 010	No Function
			011 ó 030	Auto 1
			031 ó 050	Auto 2
			051 ó 070	Auto 3
			071 ó 090	Auto 4
			091 ó 110	Auto 5
			111 ó 130	Auto 6
			131 ó 150	Auto 7
			151 ó 170	Auto 8
			171 ó 190	Auto 9
			191 ó 210	Auto 10
			211 ó 230	Auto 11
			231 ó 255	Auto 12
50	Auto Speed		000 ó 255	When Auto 01–12 in CH. 49 are activated
51	Dimmer		000 ó 255	0–100%
52	Strobe		000 ó 010	No function
			011 ó 255	0–30 Hz
53	Dimmer Speed		000 ó 010	Preset dimmer speed from display menu
			011 ó 020	WW/CW Mode On (hold for 5 sec.)
			021 ó 030	WW/CW Mode Off (hold for 5 sec.)
			031 ó 051	No function
			052 ó 101	Linear dimmer
			102 ó 152	Nonlinear dimming curve 1 (fastest)
			153 ó 203	Nonlinear dimming curve 2
			204 ó 255	Nonlinear dimming curve 3 (slowest)

48-Channel

48Ch	Channel	Function	Value	PercentSetting
	1	Red 1	000 ó 255	0-100%
	2	Green 1	000 ó 255	0-100%
	3	Blue 1	000 ó 255	0-100%
	4	Red 2	000 ó 255	0-100%
	5	Green 2	000 ó 255	0-100%
	6	Blue 2	000 ó 255	0-100%
	7	Red 3	000 ó 255	0-100%
	8	Green 3	000 ó 255	0-100%
	9	Blue 3	000 ó 255	0-100%
	10	Red 4	000 ó 255	0-100%
	11	Green 4	000 ó 255	0-100%
	12	Blue 4	000 ó 255	0-100%
	13	Red 5	000 ó 255	0-100%
	14	Green 5	000 ó 255	0-100%
	15	Blue 5	000 ó 255	0-100%
	16	Red 6	000 ó 255	0-100%
	17	Green 6	000 ó 255	0-100%
	18	Blue 6	000 ó 255	0-100%
	19	Red 7	000 ó 255	0-100%
	20	Green 7	000 ó 255	0-100%
	21	Blue 7	000 ó 255	0-100%
	22	Red 8	000 ó 255	0-100%
	23	Green 8	000 ó 255	0-100%
	24	Blue 8	000 ó 255	0-100%
	25	Red 9	000 ó 255	0-100%
	26	Green 9	000 ó 255	0-100%
	27	Blue 9	000 ó 255	0-100%
	28	Red 10	000 ó 255	0-100%
	29	Green 10	000 ó 255	0-100%
	30	Blue 10	000 ó 255	0-100%
	31	Red 11	000 ó 255	0-100%
	32	Green 11	000 ó 255	0-100%
	33	Blue 11	000 ó 255	0-100%
	34	Red 12	000 ó 255	0-100%
	35	Green 12	000 ó 255	0-100%
	36	Blue 12	000 ó 255	0-100%
	37	Red 13	000 ó 255	0-100%
	38	Green 13	000 ó 255	0-100%
	39	Blue 13	000 ó 255	0-100%
	40	Red 14	000 ó 255	0-100%
	41	Green 14	000 ó 255	0-100%
	42	Blue 14	000 ó 255	0-100%
	43	Red 15	000 ó 255	0-100%
	44	Green 15	000 ó 255	0-100%
	45	Blue 15	000 ó 255	0-100%
	46	Red 16	000 ó 255	0-100%
	47	Green 16	000 ó 255	0-100%
	48	Blue 16	000 ó 255	0-100%

9-Channel

9Ch	Channel	Function	Value	Percent/Setting
	1	Dimmer	000 ó 255	0–100%
	2	Red	000 ó 255	0–100%
		Warm White		When values 011-020 in CH. 9 are activated
	3	Green	000 ó 255	0–100%
		Cool White 1		When values 011-020 in CH. 9 are activated
	4	Blue	000 ó 255	0–100%
	5	Strobe	000 ó 009	No function
			010 ó 255	0–20 Hz
	6	Color Macro + White Balance	000 ó 010	No function
			011 ó 030	R: 100% G: 0–100% B: 0
			031 ó 050	R: 100%–0 G: 100% B: 0
			051 ó 070	R: 0 G: 100% B: 0–100%
			071 ó 090	R: 0 G: 100%–0 B: 100%
			091 ó 110	R: 0–100% G: 0 B: 100%
			111 ó 130	R: 100% G: 0 B: 100%–0
			131 ó 150	R: 100% G: 0–100% B: 0–100%
			151 ó 170	R: 100%–0 G: 100%–0 B: 100%
			171 ó 200	R: 100% G: 100% B: 100%
			201 ó 205	White 1
			206 ó 210	White 2
			211 ó 215	White 3
			216 ó 220	White 4
			221 ó 225	White 5
			226 ó 230	White 6
			231 ó 235	White 7
	236 ó 240	White 8		
	241 ó 245	White 9		
	246 ó 250	White 10		
	251 ó 255	White 11		
	7	Auto Programs	000 ó 010	No function
			011 ó 033	Auto 1
			034 ó 055	Auto 2
			056 ó 077	Auto 3
			078 ó 099	Auto 4
			100 ó 121	Auto 5
			122 ó 144	Auto 6
			145 ó 166	Auto 7
			167 ó 188	Auto 8
			189 ó 210	Auto 9
			211 ó 232	Fade 1
	233 ó 255	Fade 2		
	8	Auto Speed	000 ó 255	When values 011–255 in CH. 7 are activated
	9	Dimmer Speed	000 ó 010	Preset dimmer speed from display menu
			011 ó 020	WW/CW mode on (hold for 5 sec.)
			021 ó 030	WW/CW mode off (hold for 5 sec.)
			031 ó 051	No function
			052 ó 101	Linear dimmer
			102 ó 152	Nonlinear dimming curve 1 (fastest)
			153 ó 203	Nonlinear dimming curve 2
	204 ó 255	Nonlinear dimming curve 3 (slowest)		

5-Channel

5Ch	Channel	Function	Value	Percent/Setting
	1	Dimmer	000 ó 255	0–100%
	2	Red	000 ó 255	0–100%
	3	Green	000 ó 255	0–100%
	4	Blue	000 ó 255	0–100%
	5	Strobe	000 ó 010 011 ó 255	No function 0–20 Hz

3-Channel

3Ch	Channel	Function	Value	Percent/Setting
	1	Red	000 ó 255	0–100%
	2	Green	000 ó 255	0–100%
	3	Blue	000 ó 255	0–100%

5. Technical Information

Product Maintenance

To maintain optimum performance and minimize wear, you should clean this product frequently. Usage and environment are contributing factors in determining the cleaning frequency.

As a rule, clean this product at least twice a month. Dust build-up reduces light output performance and can cause overheating. This can lead to reduced light source life and increased mechanical wear.

To clean your product:

1. Unplug the product from power.
2. Wait until the product has reached room temperature.
3. Use a vacuum (or dry compressed air) and a soft brush to remove dust collected on the external vents.
4. Clean all external surfaces with a mild solution of non-ammonia glass cleaner or isopropyl alcohol.
5. Apply the solution directly to a soft, lint-free cotton cloth or a lens cleaning tissue.
6. Wipe any dirt or grime to the outside edges of the lens surface.
7. Gently polish the lens surfaces until they are free of haze and lint.



Always dry the external surfaces thoroughly and carefully after cleaning them.



Do not spin the cooling fans using compressed air because you could damage them.

Returns

- The product must be sent prepaid, in the original box, and with the original packing and accessories. Chauvet will not issue call tags.
- Call Chauvet and request a Return Merchandise Authorization (RMA) number before shipping the product. Be prepared to provide the model number, serial number, and a brief description of the cause(s) for the return.
- Clearly label the package with an RMA number. Chauvet will refuse any product returned without an RMA number.



Do not write the RMA number directly on the box. Write it on a label affixed to the box.

Once you have received the RMA number, include the following information on a piece of paper inside the box:

- Your name
- Your address
- Your phone number
- The RMA number
- A brief description of the problem(s)

Be sure to pack the product properly. Any shipping damage resulting from inadequate packaging will be the customer's responsibility. FedEx packing or double boxing is recommended.



Chauvet reserves the right to use its own discretion to repair or replace returned product(s).

6. Technical Specifications

Dimensions and Weight	Length	Width	Height	Weight
	18.07 in (462 mm)	6.61 in (168 mm)	18.07 in (462 mm)	28.6 lb (13 kg)

Dimensions in inches rounded to the nearest decimal digit.

Electrical	Power Supply Type	Range		Voltage Selection
	Switching (internal)	100 to 240 VAC, 50/60 Hz		Auto-ranging
	Parameter	120 VAC, 60 Hz	208 VAC, 50 Hz	230 VAC, 50 Hz
	Consumption	401 W	393 W	394 W
	Operating current	3.35 A	1.9 A	1.71 A
	Power linking (products)	4	7	8
	Fuse	T 5 A, 250 V	T 5 A, 250 V	T 5 A, 250 V

Power I/O	U.S./Worldwide	Europe
Power input connector	Neutrik® powerCON® A	Neutrik® powerCON® A
Power output connector	Neutrik® powerCON® B	Neutrik® powerCON® B
Power cord plug	Edison (U.S.)	Local plug

Light Source	Type	Power	Lifespan
	LED	27 W	50,000 hours
	Color	Quantity	Current
	Tri-color (RGB)	16	2 A

Photo Optic	Parameter	Standard Optics
	Illuminance @ 5 m	484 lux
	Beam angle	45°
	Field angle	75°

Thermal	Max. External Temperature	Cooling System
	113 °F (45 °C)	Fan-assisted Convection

DMX	I/O Connectors	Connector Type	Channel Range
	3- and 5-pin XLR	Sockets	3, 5, 9, 48 or 53

Art-Net™/Kling-Net	I/O Connectors	Connector Type	Channel Range
	Neutrik® etherCON®	Sockets	48 (Art-Net™)

Ordering	Product Name	Item Code	UPC Number
	Nexus™ 4x4 (1-pack)	03090656	781462210045
	Nexus™ 4x4 (4-pack)	03090677	781462210250



UL 1573
CSA C22.2 No. 166
E113093



Contact Us

WORLD HEADQUARTERS - Chauvet

General Information

Address: 5200 NW 108th Avenue
Sunrise, FL 33351
Voice: (954) 577-4455
Fax: (954) 929-5560
Toll free: (800) 762-1084

Technical Support

Voice: (954) 577-4455 (Press 4)
Fax: (954) 756-8015
Email: tech@chauvetlighting.com

World Wide Web

www.chauvetlighting.com

UNITED KINGDOM AND IRELAND - Chauvet Europe Ltd.

General Information

Address: Unit 1C
Brookhill Road Industrial Estate
Pinxton, Nottingham, UK
NG16 6NT
Voice: +44 (0)1773 511115
Fax: +44 (0)1773 511110

Technical Support

Email: uktech@chauvetlighting.com

World Wide Web

www.chauvetlighting.co.uk

MEXICO - Chauvet Mexico

General Information

Address: Av. Santa Ana 30
Parque Industrial Lerma
Lerma, Mexico C.P. 52000
Voice: +52 (728) 285-5000

Technical Support

Email: servicio@chauvet.com.mx

World Wide Web

www.chauvet.com.mx

Outside the U.S., United Kingdom, Ireland, or Mexico, contact your dealer. Follow their instructions to request support or to return a product. Visit our website for contact details.