



CMA162

Cluster mounting set 2 x ATEO6 speaker

Product information:

The CMA162 is a cluster mounting set, allowing assembly for 2 pcs of ATEO6 speakers to any ceiling. This solution is designed for applications in large open indoor spaces where a uniform sound dispersion in all directions is required. Some typical application examples are sports facilities, gym's, large warehouses, hallways, and many more.

The CMA162 is constructed of solid steel and comes fully assembled, including pole and ceiling mount. The distance to the ceiling measures 360 mm and the pole allows cable integration, so a clean and elegant solution is offered.

The tilted mounting plates in combination with the Clevermount™ bracket structure allows optimal directional placement in any application.

The CMA series also come in a 4 speaker model (CMA164), allowing mounting of speakers in all 4 directions and are available in both Black (/B) or White (/W) colours, to match the speakers colour and blend in with the environment.

The CMA162 comes delivered excluding the loudspeakers.



Product Features:

Dimensions	179.2 x 357.5 x 140 mm (W x H x D)
Construction	Steel
Finish	Structured powder coating
Max. load	10 kg (5 kg / each side)
Suited for	ATEO6 loudspeakers
Accessories	Included Speaker mounting screws

Variants:

- CMA162/B - Black
- CMA162/W - White

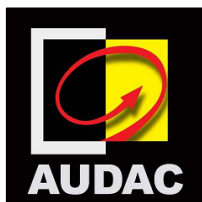
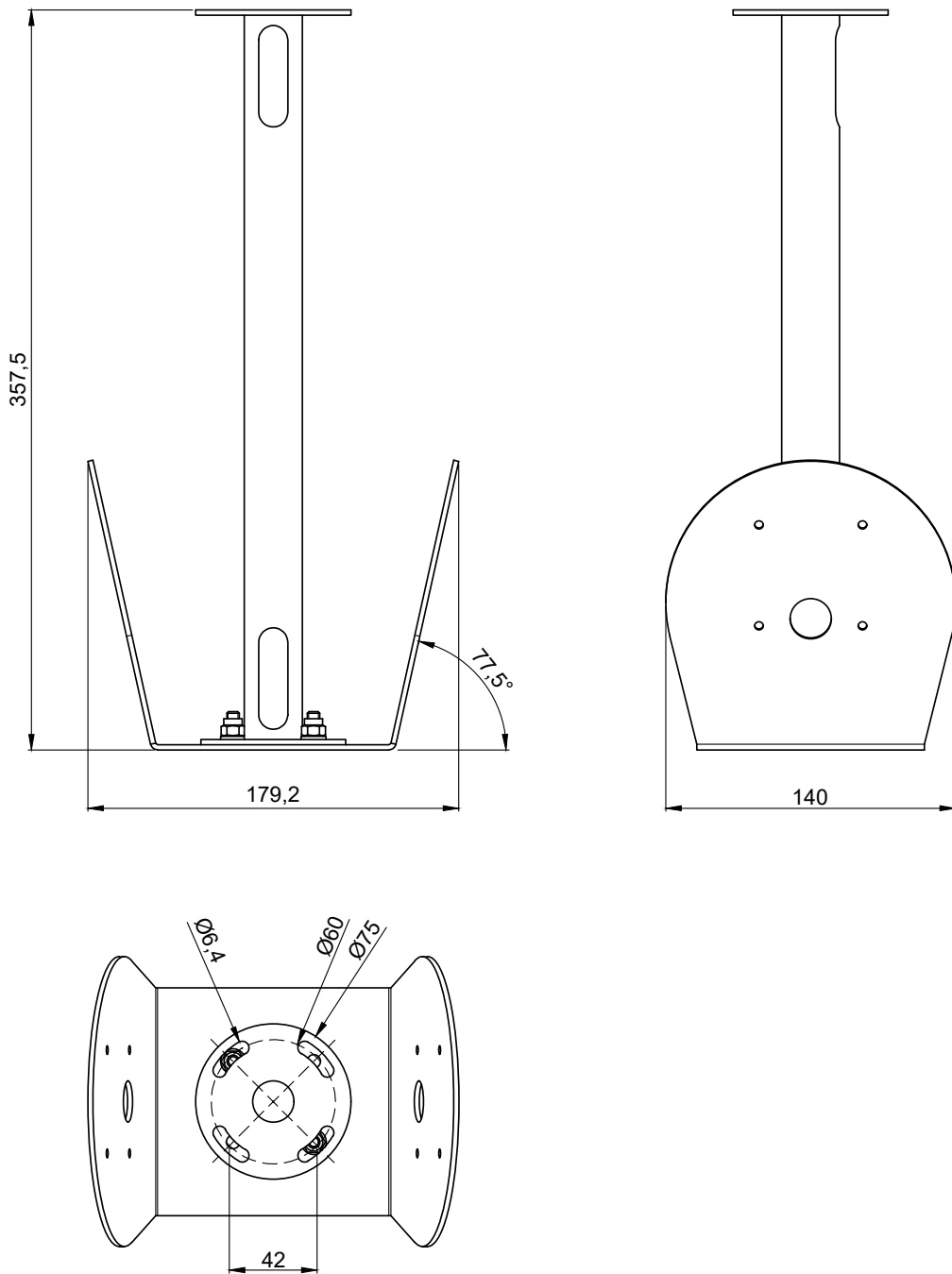

CMA162

Product description:
CLUSTER MOUNTING SET 2 x ATEO6
SPEAKER

Weight:
1,36 kg

Outer dimensions:
(w x h x d)
179,2 x 357,5 x 140

Unit height:
N/A