



Spectrum W1

QUICK START GUIDE

1

Tilslut den medfølgende strømforsyning.

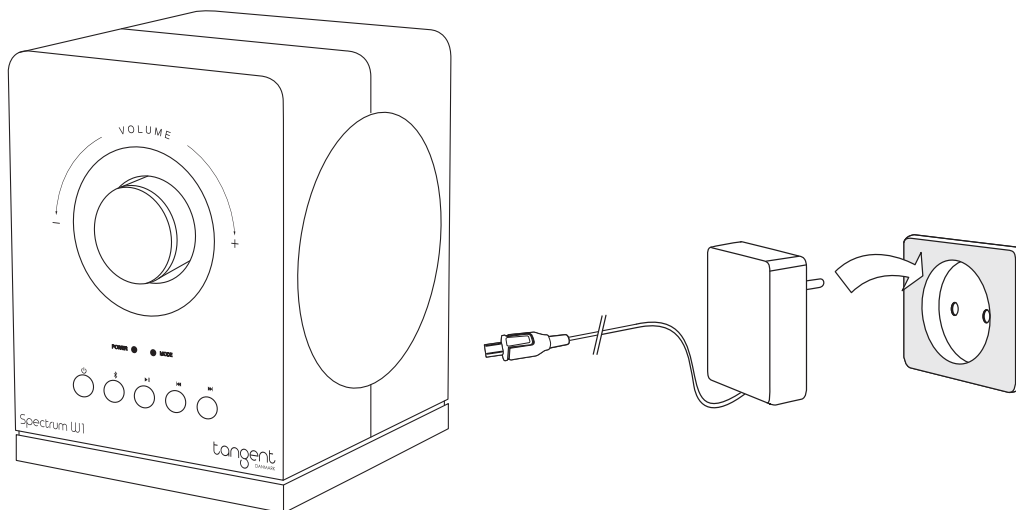

Når du tilslutter strømmen første gang, lyser POWER led rød efter 3sek slukker den igen. De næste 35sek er der ikke noget lys, men så vil POWER led blive hvid og MODE LED vil blinke hvidt. Så er din Spectrum W1 klar til at blive konfigureret.

2 Configurer netværket på Spectrum W1, ved at bruge Google Home app'en.

Hvis du ikke allerede har app'en, så kan du downloade den direkte fra Google Play eller Apple App Store.

Åbn appen og følg instruktionerne. For yderligere hjælp, gå ind på Google Home support side.

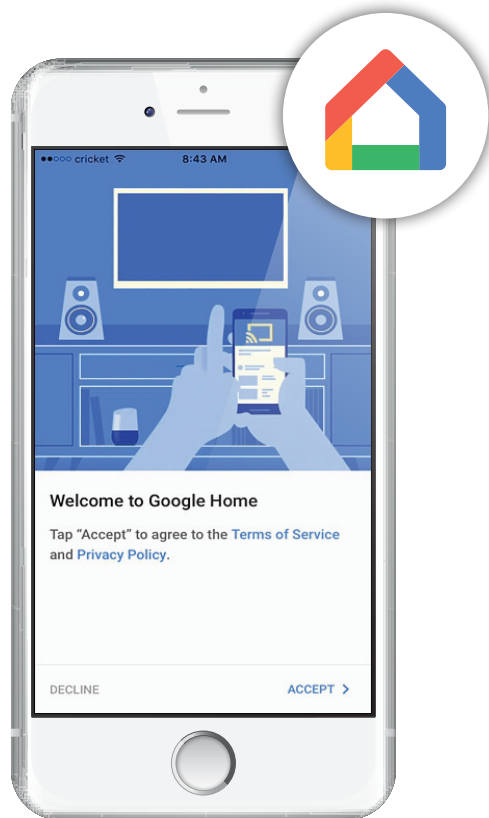

3 Tryk på For at slukke og tænde.

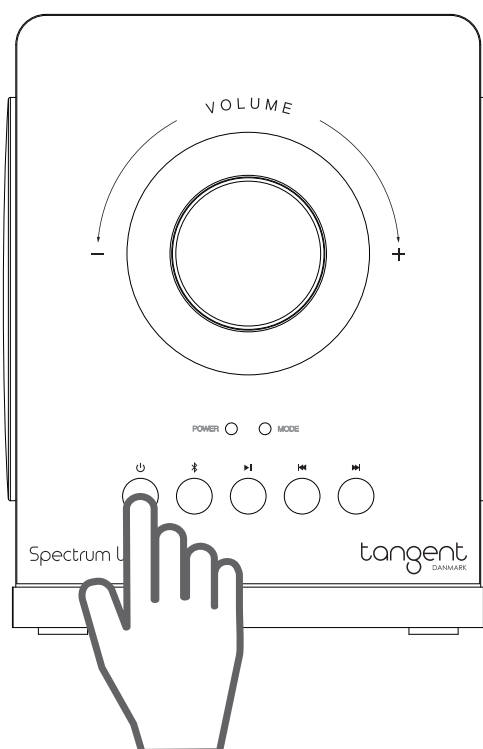

4

Chromecast mode (Grøn Led)

Åben en app der er Chromecast-enabled (Spotify, Google Play Music, Yousee Musik osv...).

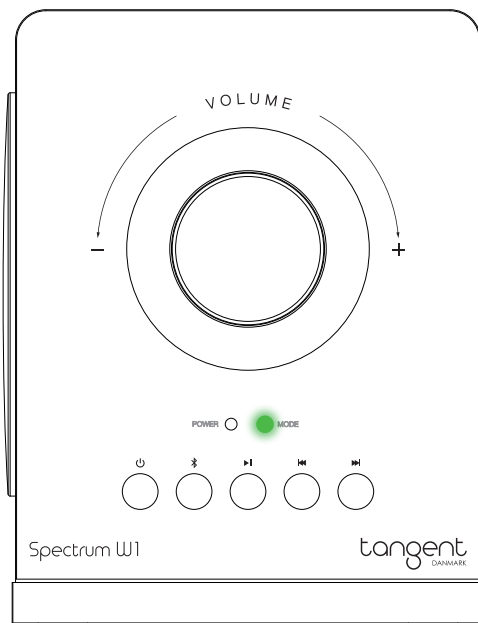

I app'en skal du blot trykke på cast ikon'et  og vælge den højttaler eller eller højttaler gruppe du ønsker at afspille på.



Besøg Google Chromecast hjemmesiden for kompatible apps og for mere information.

5

Bluetooth mode (Blå LED)

Tryk  for at vælge Bluetooth mode.

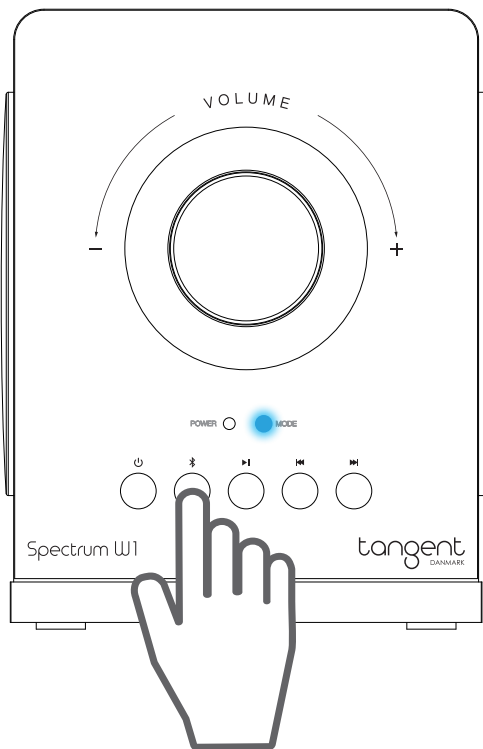

Højttaleren vil nu gå i pairing mode. Tænd Bluetooth på din afspiller og vælg "Spectrum W1 XXXX" på bluetooth listen

6

AUX In mode (Lilla LED)

Tilslut din lydkilde via 3.5mm audio kabel, og Spectrum W1 vil automatisk skifte til AUX mode.

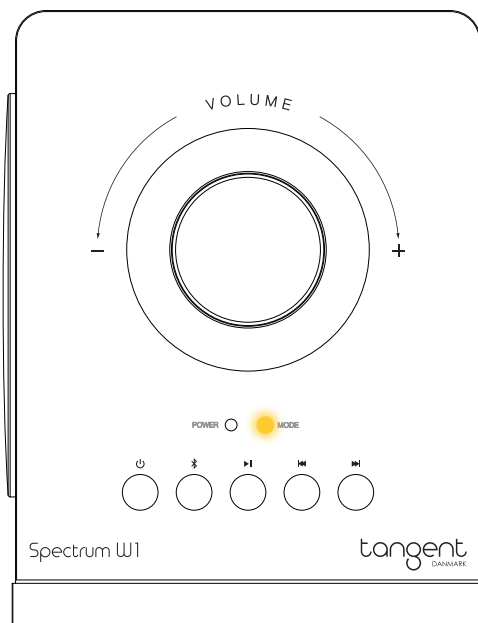



Spectrum W1

GUIDE DE DÉMARRAGE RAPIDE

1

Connectez le câble d'alimentation à l'enceinte, puis branchez la prise secteur.

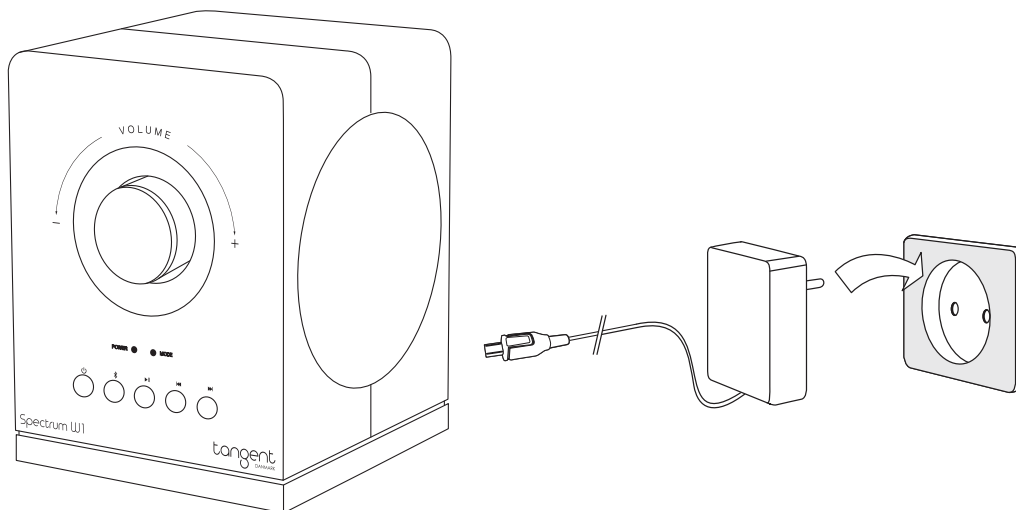

Lors du premier branchement, la LED Power devient rouge après 3 secondes, puis s'éteint. Au bout de 35 secondes, la LED Power devient blanche, et la LED Mode clignote blanc. L'enceinte est désormais prête à être configurée.

- 2** Configurez les paramètres réseau à l'aide de l'application Google Home sur votre appareil.

Si vous n'avez pas l'application, vous pouvez la télécharger directement depuis Google Play ou l'App Store Apple.

Lancez l'application et suivez les instructions. Pour toute aide supplémentaire, consultez la page d'assistance de Google Home.

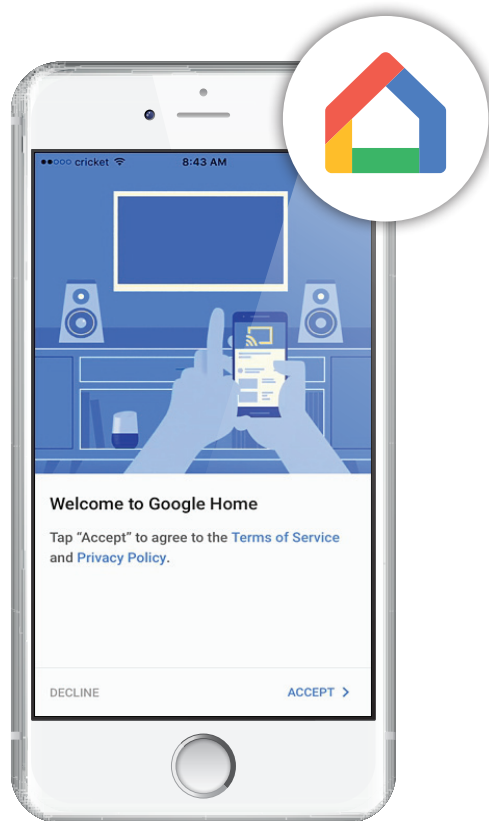

- 3** Appuyez sur  pour changer de mode.

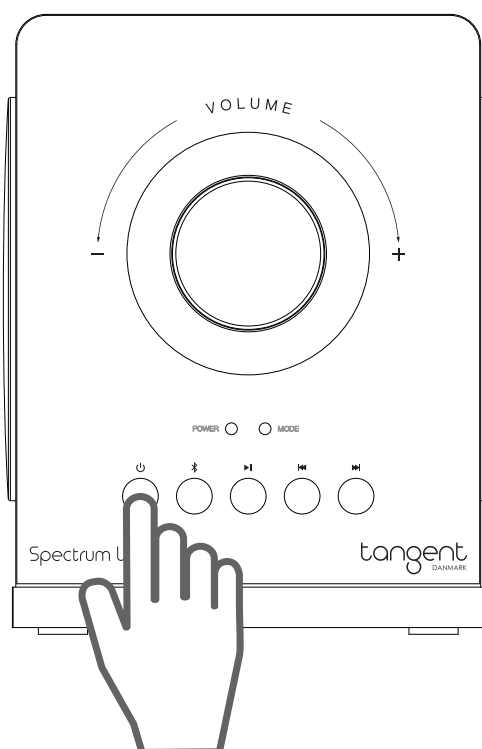

4

Mode Chromecast (LED verte)

Lancez n'importe quelle application compatible Chromecast (Spotify, Google Play Music...).

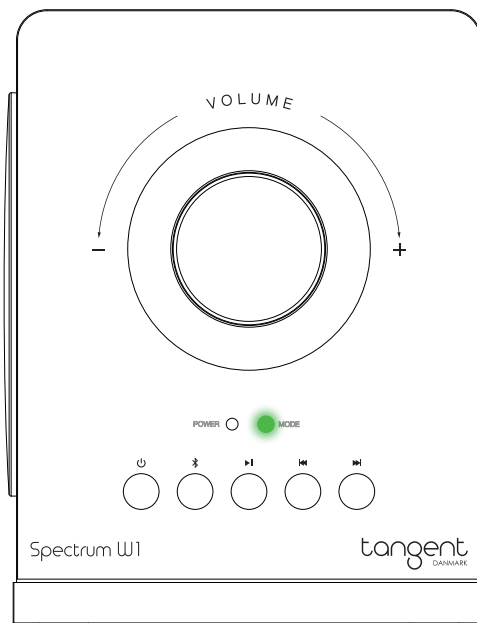

Cliquez sur l'icône  de votre application et sélectionnez l'enceinte ou le groupe d'enceinte pour écouter.



Retrouvez toutes les applications compatibles sur le site Google Chromecast. Pour plus d'informations, consultez le site de l'application concernée.

5

Mode Bluetooth (LED bleue)

Appuyez sur  pour lancer le mode Bluetooth.

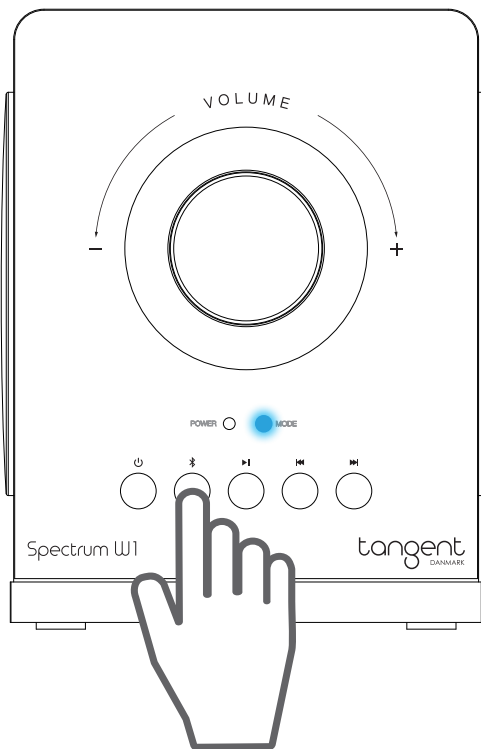

L'enceinte entre automatiquement en mode appairage. Allumez votre appareil Bluetooth et sélectionnez "Spectrum W1 XXXX" dans la liste.

6

Mode AUX (LED orange)

Connectez la source audio à l'aide du câble 3,5 mm, l'enceinte entre automatiquement en mode AUX.

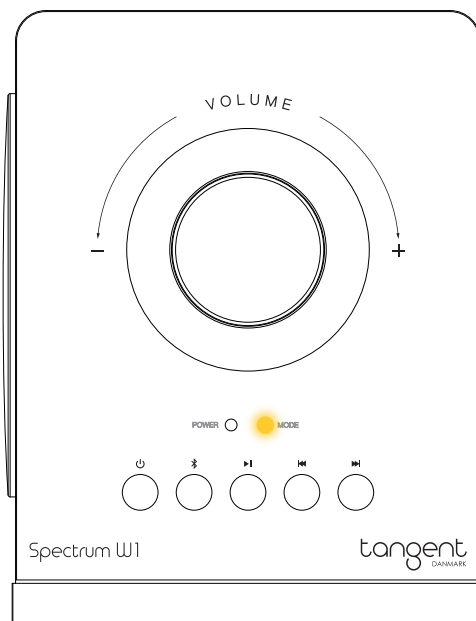



Spectrum W1

QUICK START GUIDE

1

Connect the power adaptor to the speaker and plug into power socket.

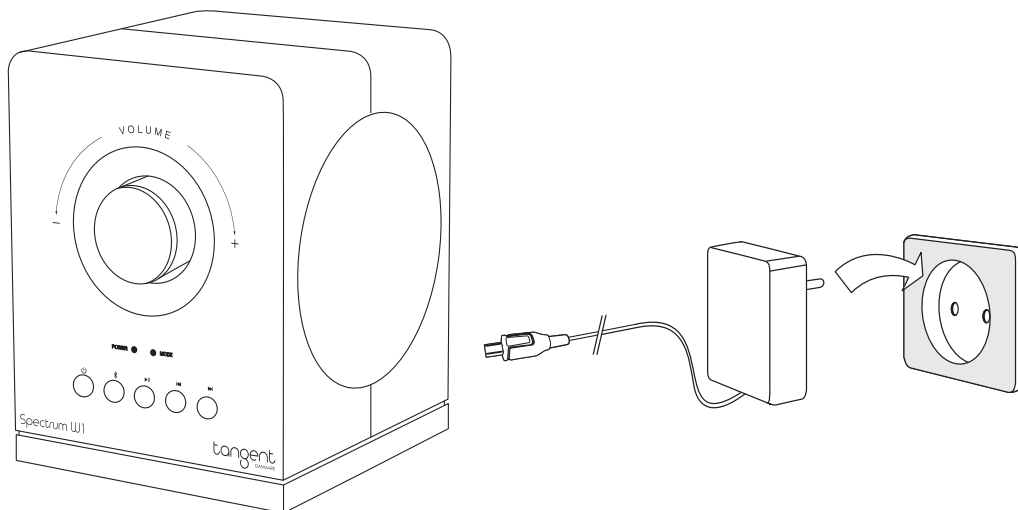

When first connected to power, power LED will light up red after 3 sec, and then light off. After 35s of waiting, the power LED will light up white, and the MODE LED will be flashing white. Your speaker is now ready for configuration.

2

Set up the network configuration using Google Home app.

If you don't have it yet, you can download it directly from Google Play or the Apple App Store.

Open the app and follow the instructions. For additional help, visit Google Home support page.

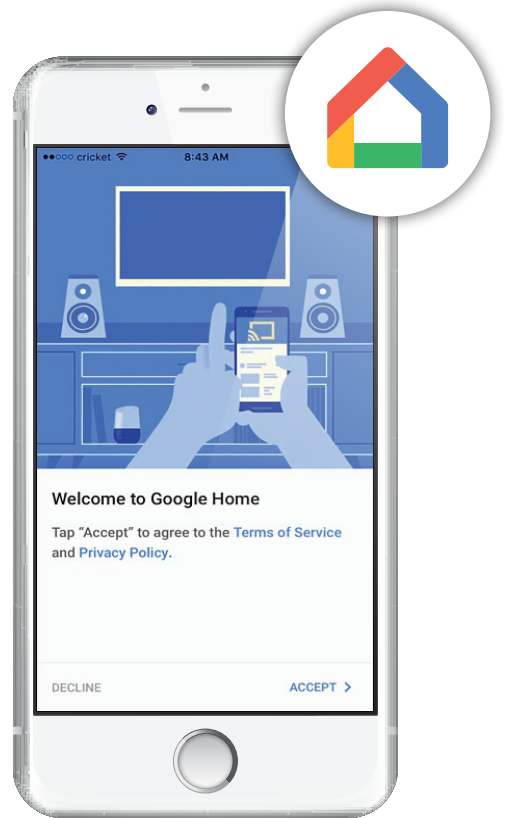

3

Press  to switch between modes.

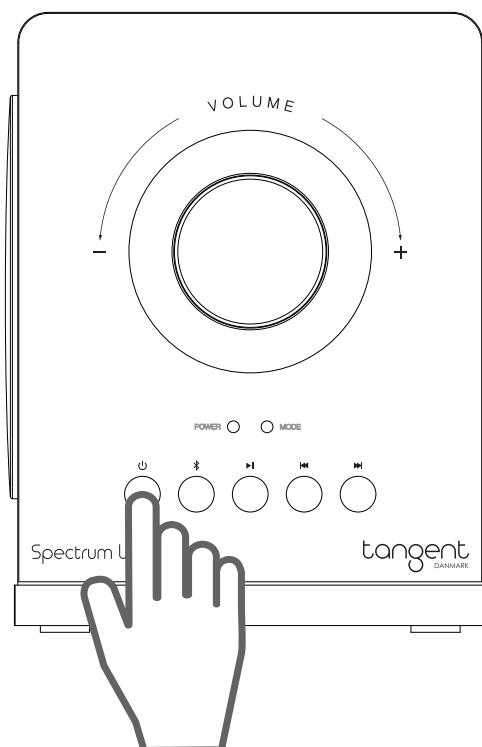

4

Chromecast mode (green light)

Open any Chromecast-enabled app (Spotify, Google Play Music...).

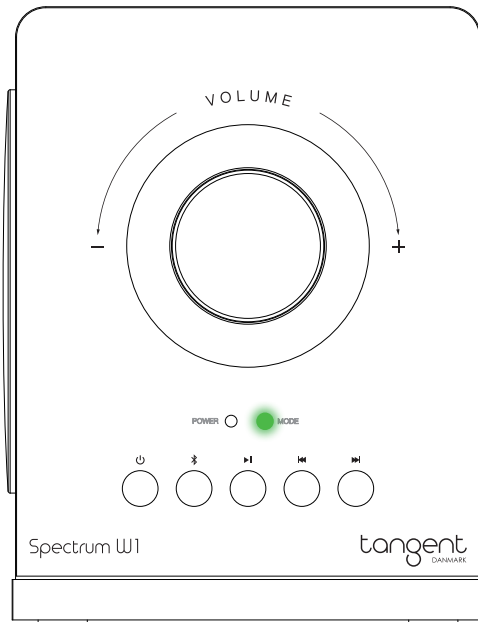

Tap the cast icon  on the app and select the speaker or group of speaker to play.



Visit Google Chromecast page for a list of compatible apps and app provider for further information.

5

Bluetooth mode (blue light)

Press  to go Bluetooth mode.

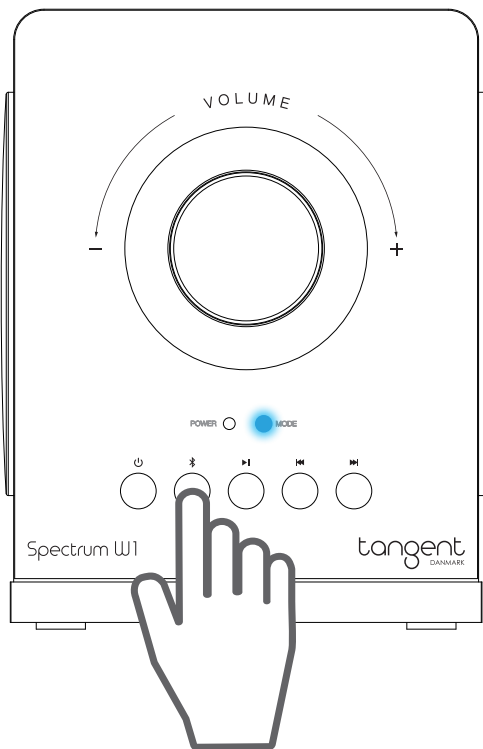

The W1 will enter pairing stage. Turn on your Bluetooth device and select "Spectrum W1 XXXX" in the list.

6

AUX In mode (amber light)

Connect the audio source via 3.5 mm audio cable, the speaker will automatically enter AUX mode.

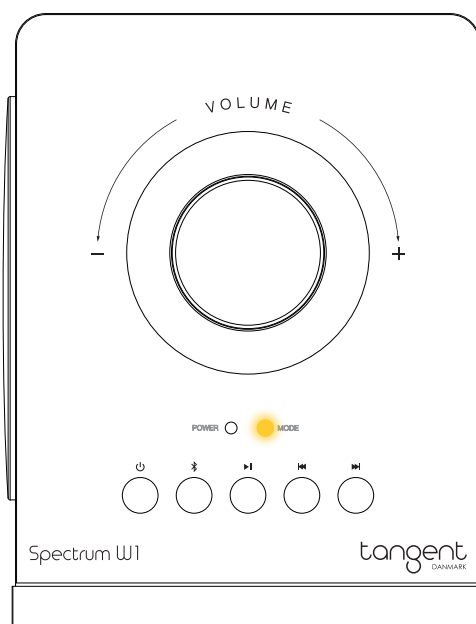



Spectrum W1

KURZANLEITUNG

1

Schließen Sie das Netzteil an das W1 an und stecken Sie es in die Steckdose.

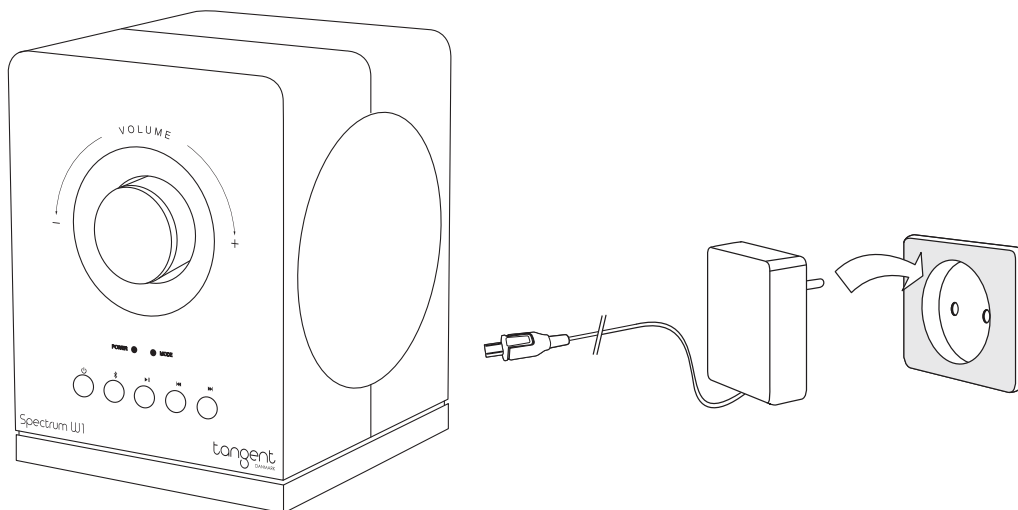



Beim ersten Einschalten leuchtet die Betriebs-LED nach 3 Sekunden rot und erlischt dann. Nach 35 Sekunden leuchtet die Power-LED weiß und die MODE-LED blinkt weiß. Ihr Lautsprecher ist nun bereit für die Konfiguration.

2 Richten Sie die Netzwerkkonfiguration mit der Google Home App ein.

Wenn Sie es noch nicht haben, können Sie es direkt von Google Play oder dem Apple App Store herunterladen.

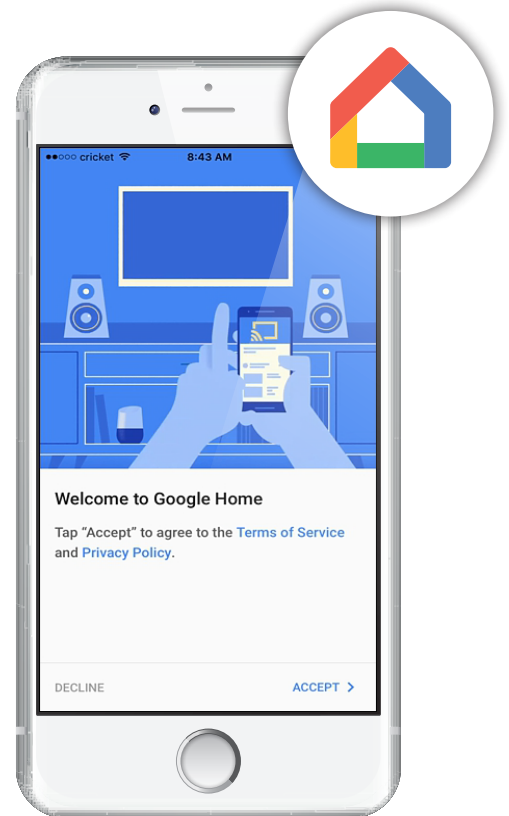
Öffne die App und folge den Anweisungen. Weitere Informationen erhalten Sie auf der Google Home-Supportseite.



3 Trykk  for å slå på / av. I standby-modus slår W1 på automatisk når du velger den som Cast enhet

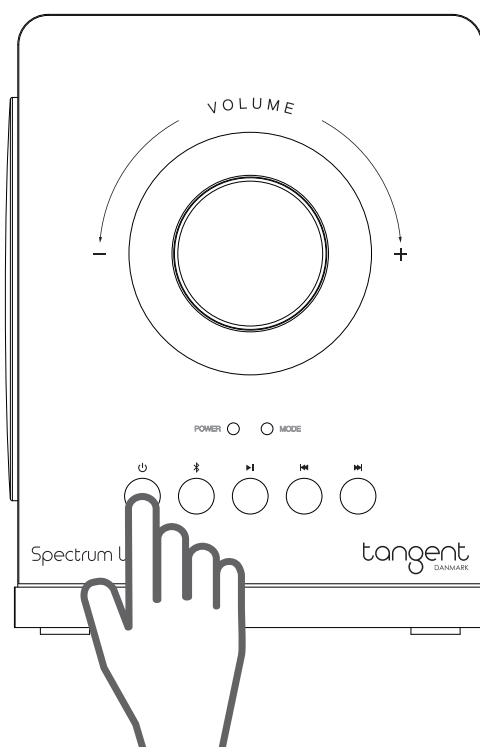

4

Chromecast-Modus (grünes Licht)

Öffnen Sie eine Chromecast-fähige App (Spotify, Google Play Music ...).

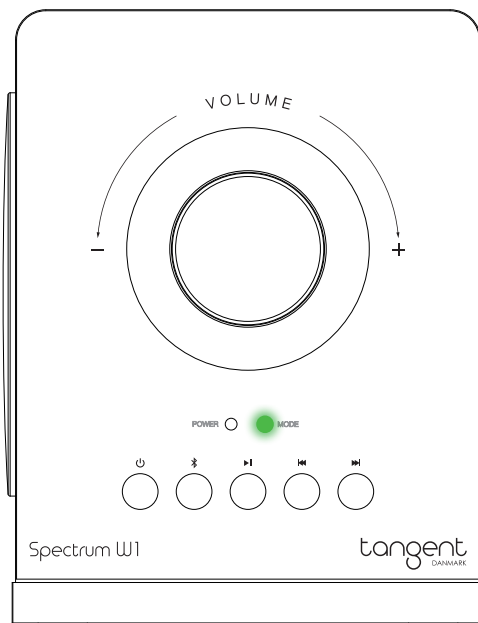

Tippen Sie auf das Cast-Symbol  in der App und wählen Sie den Lautsprecher oder die Gruppe von Lautsprechern für die Wiedergabe aus.



Auf der Google Chromecast-Seite finden Sie eine Liste kompatibler Apps und Anbieter für weitere Informationen.

5

Bluetooth-Modus (blaues Licht)

Drücken Sie , um in den Bluetooth-Modus zu wechseln.

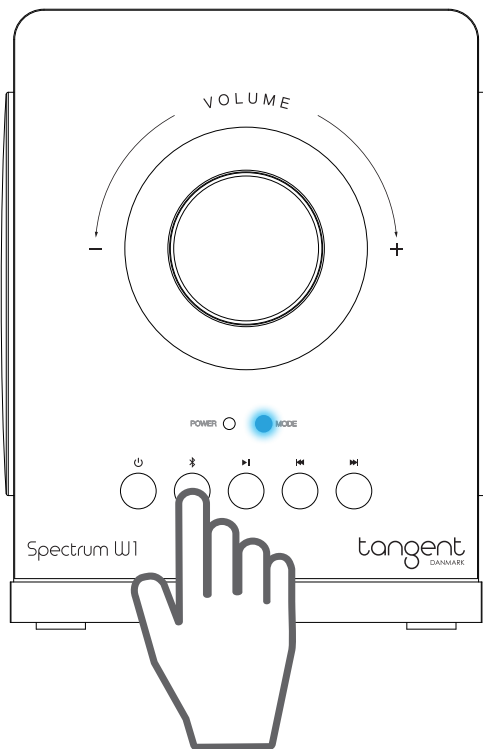

Das W1 wechselt in die Pairing-Phase. Schalten Sie Ihr Bluetooth-Gerät ein und wählen Sie "Spectrum W1 XXXX" in der Liste.

6

AUX In-Modus (Gelb Licht)

Schließen Sie die Audioquelle über ein 3,5-mm-Audiokabel an, der Lautsprecher wechselt automatisch in den AUX-Modus.

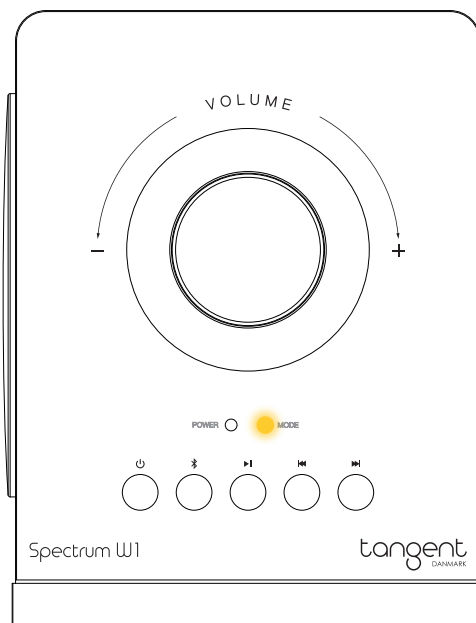



Spectrum W1

PIKAOPAS

1

Kytke virtalähde kaiuttimeen ja liitä se pistorasiaan.

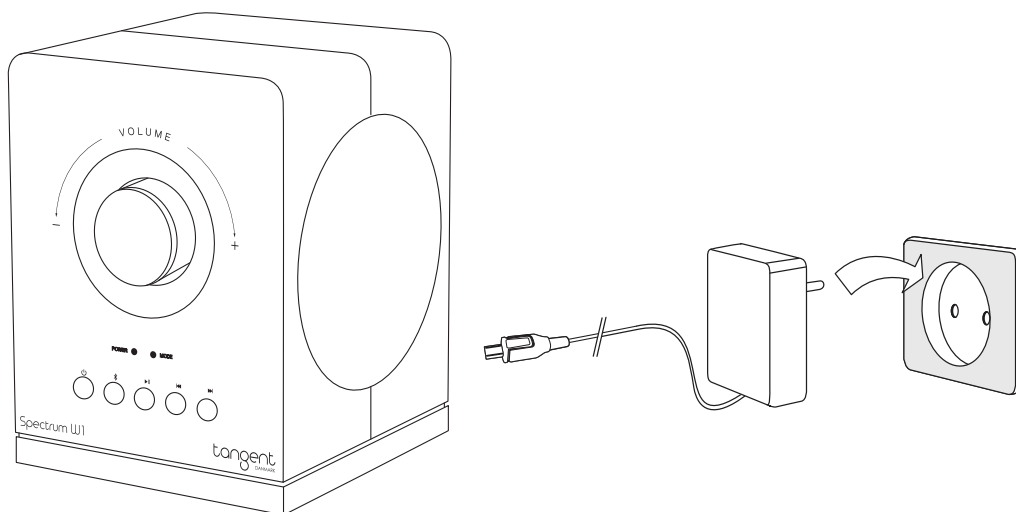

Kun virta kytketään ensimmäistä kertaa, virran merkkivalo palaa punaisena 3 sekunnin kuluttua ja sammuu sitten. 35:n odotustilan jälkeen virran merkkivalo syttyy valkoiseksi ja MODE-merkkivalo vilkkuu valkoisena. Kaiutin on nyt valmis kokoonpanoon.

2

Määritä verkkoasetukset Google Home -sovelluksella.

Jos sinulla ei vielä ole, voit ladata sen suoraan Google Playsta tai Applen App Storesta.

Avaa sovellus ja noudata ohjeita.

Lisätietoja on Googlen kotisivujen tukisivulla.

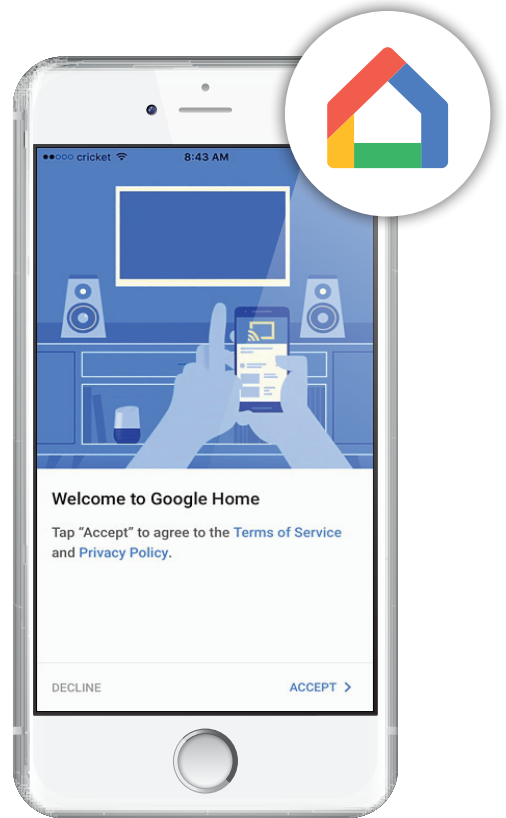

3

Paina  ON / OFF-painiketta.

Valmiustilassa W1 käynnistyy automaattisesti, kun valitset sen Cast-laitteena

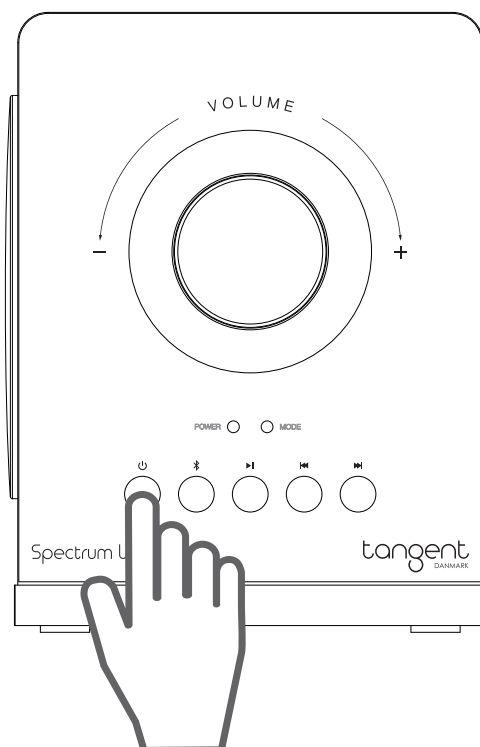

4

Chromecast-tila (vihreä valo)

Avaa Chromecast-yhteensopiva sovellus (Spotify, Google Play -musiikki jne.).

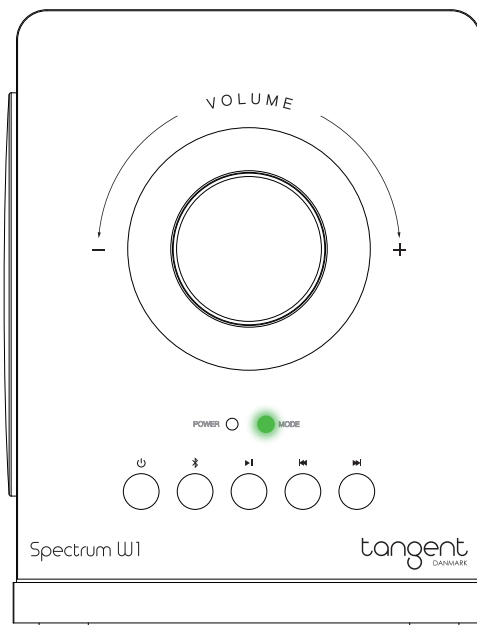

Napauta valokuvan  kuvaketta sovelluksessa ja valitse kaiutin tai kaiuteryhmä, jota haluat pelata.



Saat lisätietoja Googlen Chromecast -sivulta luettelosta yhteensopivista sovelluksista ja sovelluspalveluntarjoajasta.

5**Bluetooth-tila (sininen valo)**

Siirry  Bluetooth-tilaan painamalla.

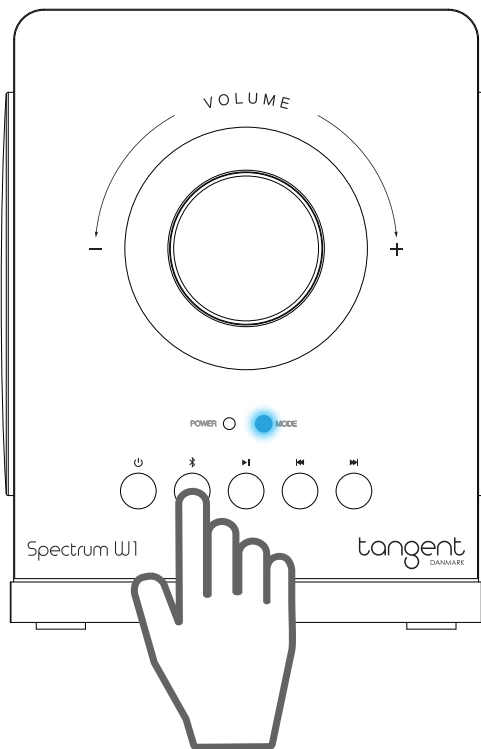

Puhuja tulee pariliitoksen vaiheeseen. Käynnistä Bluetooth-laite ja valitse luettelosta "Spectrum W1 XXXX".

6**AUX-tilassa (keltainen valo)**

Liitä äänilähde 3,5 mm: n äänikaapelilla, kaiutin siirtyy automaattisesti AUX-tilaan.

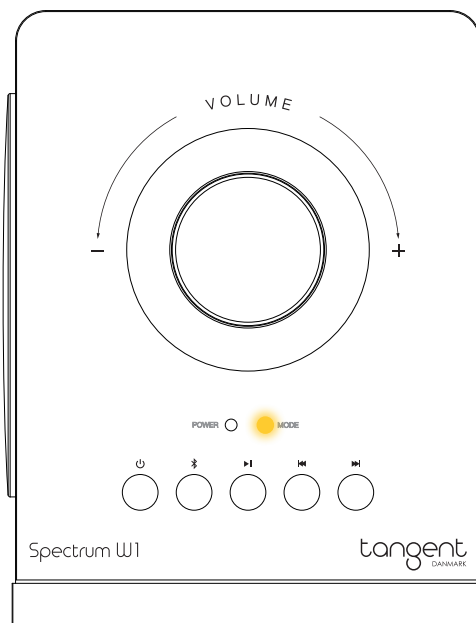



Spectrum W1

HURTIGSTARTVEILEDNING

1

Koble strømadapteren til høyttaleren og koble til strømuttaket.

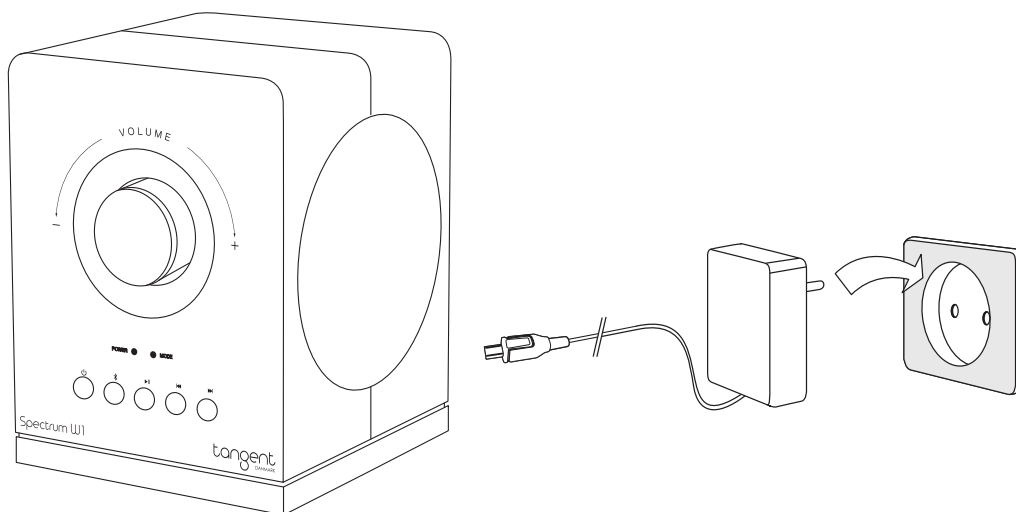

Når strømtilførselen først kobles til strøm, lyser den rødt etter 3 sekunder, og lyser deretter av. Etter 35 sekunder med venting lyser strømlampen hvit, og MODE-LED blinker hvitt. Din høyttaler er nå klar for konfigurering.

2 Konfigurer nettverkskonfigurasjonen ved hjelp av Google Home-app.

Hvis du ikke har det ennå, kan du laste den ned direkte fra Google Play eller Apple App Store.

Åpne appen og følg instruksjonene.
Hvis du vil ha mer hjelp, kan du gå til Googles startside for support.

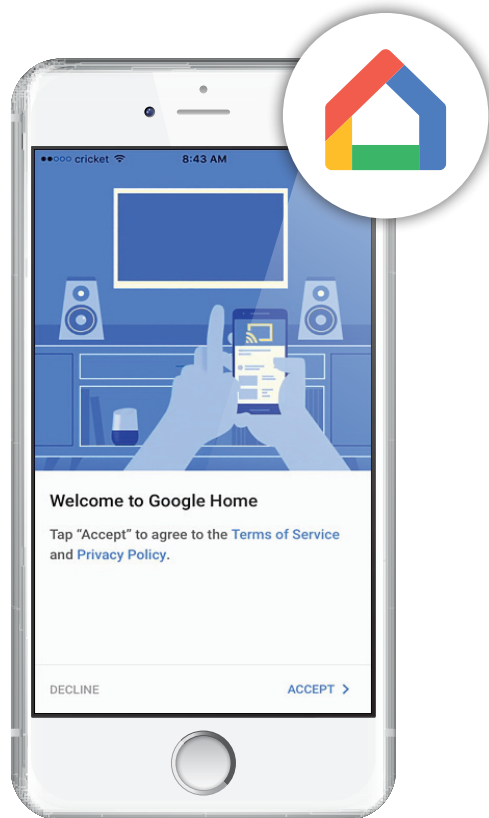

3 Trykk for å slå på / av. I standby-modus slår W1 på automatisk når du velger den som Cast-enhet

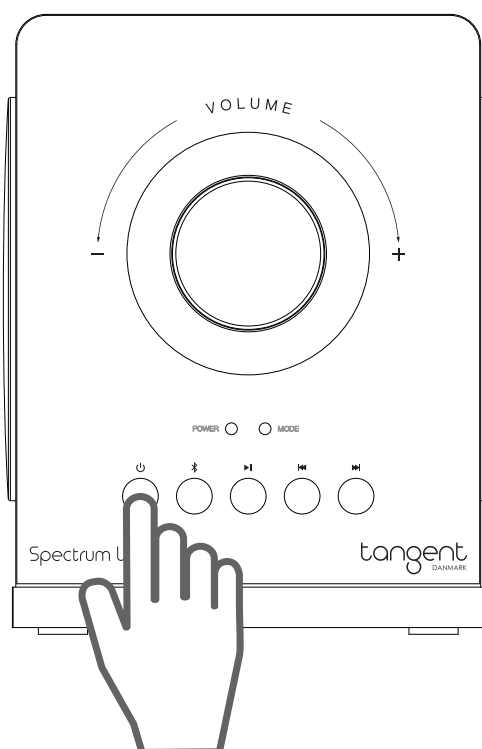

4

Chromecast-modus (grønt lys)

Åpne en Chromecast-aktivert app (Spotify, Google Play Musikk ...).

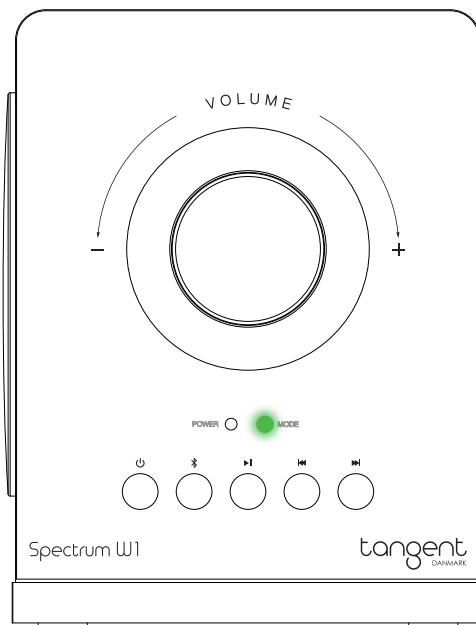

Trykk på cast-ikonet  på appen, og velg høyttaler eller gruppe av høyttaler for å spille.



Gå til Google Chromecast-siden for en liste over kompatible apper og appleverandører for ytterligere informasjon.

5

Bluetooth-modus (blått lys)

Trykk  for å gå til Bluetooth-modus.

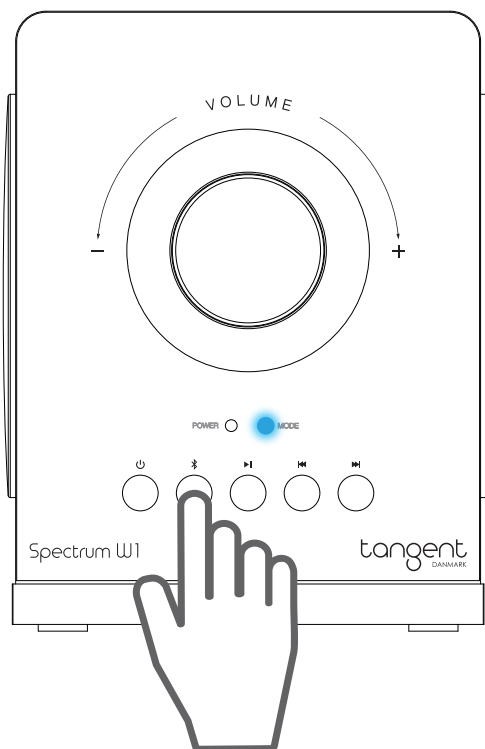

Høytaleren kommer inn i parringsstadiet. Slå på Bluetooth-enheten din og velg "Spectrum W1 XXXX" i listen.

6

AUX-inn-modus (gul lys)

Koble lydkilden via 3,5 mm lydkabel, høytaleren vil automatisk gå inn i AUX-modus.

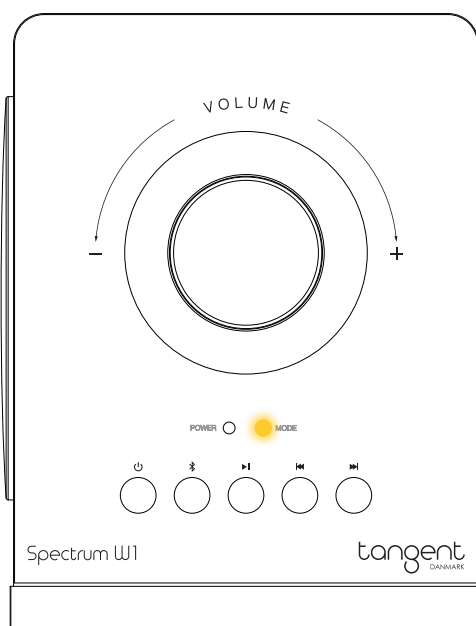



Spectrum W1

SNABBSTARTSGUIDE

1

Anslut nätadaptern till högtalaren och sätt i eluttaget.

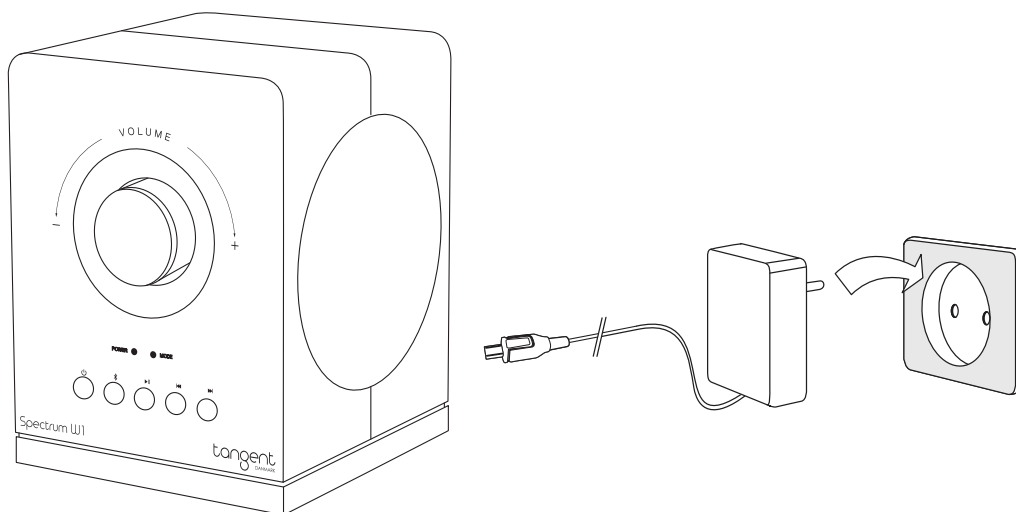



När den först ansluts till strömmen tänds lysdioden röd efter 3 sekunder och tänds sedan av. Efter 35-talet väntar lysdioden lyser vit och MODE-LED blinkar vitt. Din högtalare är nu klar för konfiguration.

- 2** Ställ in nätverkskonfigurationen med hjälp av Google Home app.

Om du inte har det ännu kan du hämta det direkt från Google Play eller Apple App Store.

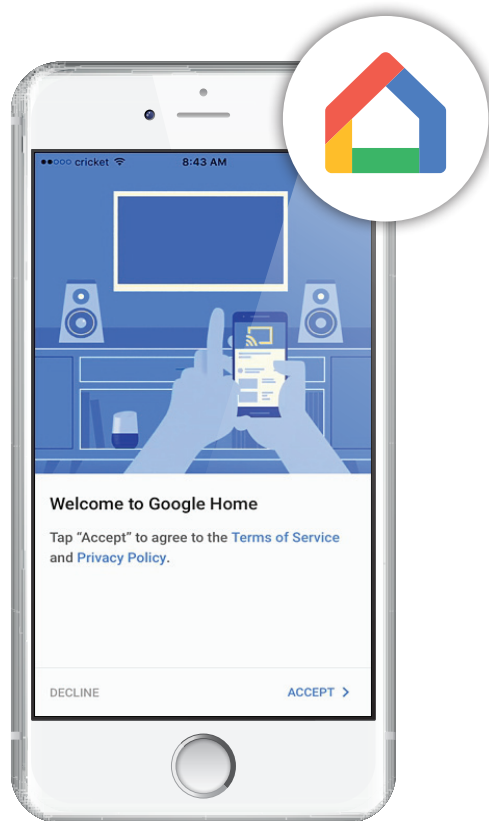
Öppna appen och följ anvisningarna. För ytterligare hjälp, besök Googles startsida för support.



- 3** Tryck  för att slå PÅ / AV. I vänteläge aktiveras W1 automatiskt när du väljer det som Cast-enhet

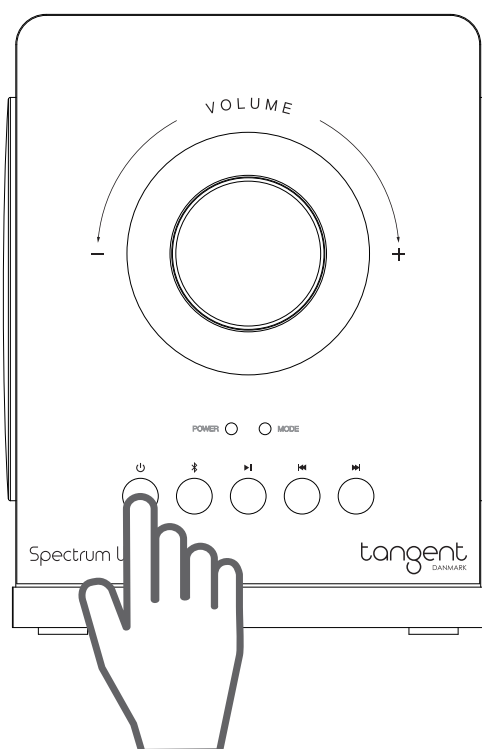

4

Chromecast-läge (grönt ljus)

Öppna alla Chromecast-aktiverade appar (Spotify, Google Play Music ...).

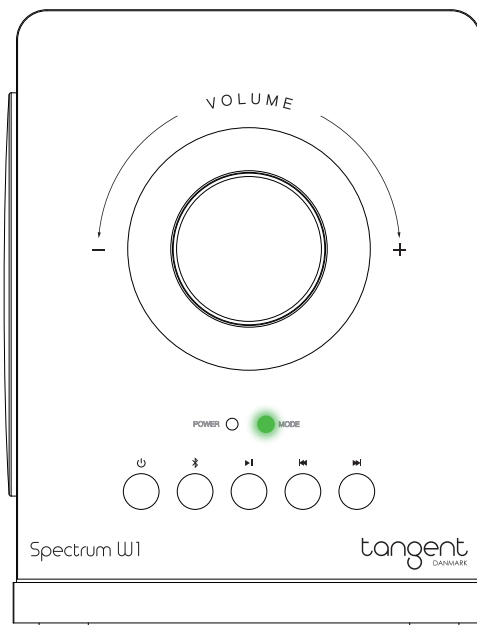
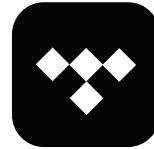

Tryck på cast-ikonen  i appen och välj högtalaren eller gruppen av högtalare för att spela upp.



Besök Google Chromecast-sidan för en lista över kompatibla appar och appleverantörer för mer information.

5

Bluetooth-läge (blått ljus)

Tryck  för att gå till Bluetooth-läge.

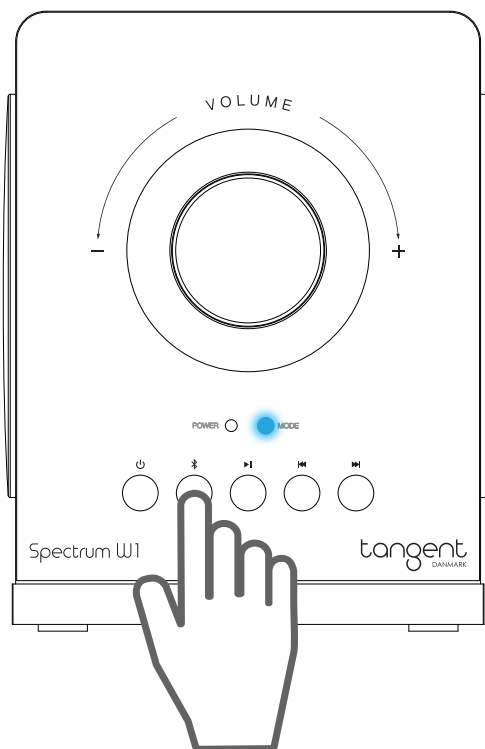

Högtalaren kommer ange parringssteget. Slå på din Bluetooth-enhet och välj "Spectrum W1 XXXX" i listan.

6

AUX in-läge (gult ljus)

Anslut ljudkällan via 3,5 mm ljudkabel, högtalaren går automatiskt in i AUX-läge.

