

Assembly Instructions

English

GSS
Grundig SAT Systems GmbH
Beuthener Strasse 43
D-90471 Nuremberg

Phone: +49 (0) 911 / 703 8877
Fax: +49 (0) 911 / 703 9210
E-mail: info@gss.de
Internet: <http://www.gss.de>



Grundig SAT Systems

Head-End Digital Modulator COFDM - PAL

HDMT 2180 P CI



Contents

1	Safety regulations and notes	4
2	General information	5
2.1	Packing contents	5
2.2	Meaning of the symbols used	5
2.3	Technical data	5
2.4	Description	6
2.5	Software query	7
3	Assembly	7
3.1	Installing the cassette	7
3.2	EMC regulations	8
3.3	Overview of the cassette	9
3.4	Connecting the cassette	9
3.5	Updating the software	9
3.6	Retrofitting a CA module	10
4	The control panel at a glance	11
4.1	Menu items	11
4.2	Control panel	11
5	Programming	12
5.1	Preparation	12
5.2	Programming procedure	12
5.3	Programming the cassette	16
	Selecting the cassette, displaying the software version	16
	Selecting the channel strip	17
	Switching the modulator off or on	18
	Adjusting the output levels of the channel strips	18
	Setting the TV standard of the output signal	19
	Selecting channel / frequency setting	19
	Setting the output channel	20
	Setting the fine-tuning	20
	Setting the output frequency	20
	Selecting the Tuner (only channel strip B)	21
	Selecting channel or frequency setting (input)	21
	Configuring the CA module (only channel strip A)	21
	Setting the input channel	23
	Setting the input frequency	23
	Setting the input signal	24
	Setting the input symbol rate	24
	Channel selection	25
	Selecting the TV station sound	26
	Setting the volume level	26

Setting the audio mode.....	26
Setting the audio output.....	26
Adjusting the picture format	27
Switching teletext mode off/on.....	27
Activating test lines	28
Locking the regional window.....	28
Subtitle settings.....	28
Setting the time zone and summer time.....	30
Setting time-controlled, alternative channels.....	31
Switching the timer on and off.....	31
Setting the duty cycle	31
Setting the days of the week.....	32
Selecting channel or frequency setting (timer, input)	32
Selecting input channel or input frequency setting (timer)	33
Setting the input signal / symbol rate (timer)	33
Channel selection (timer).....	33
Selecting the TV station sound / Setting the volume level (timer).....	34
Saving settings	34
6 Final procedures.....	35
7 Channel and frequency tables	36

1 Safety regulations and notes



- Assembly, installation and servicing should be carried out by authorised electricians.
- Switch off the operating voltage of the system before beginning with assembly or service work or pull out the mains plug.
- Do not perform installation and service work during thunderstorms.
- Install the system so it will not be able to vibrate...
 - in a dust-free, dry environment
 - in such a manner that it is protected from moisture, fumes, splashing water and dampness
 - somewhere protected from direct sunlight
 - not within the immediate vicinity of heat sources
 - in an ambient temperature of 0 °C to +50 °C. In case of the formation of condensation wait until the system is completely dried.
- Ensure that the head-end station is adequately ventilated. Do not cover the ventilation slots.
- Beware of short circuits
- No liability is accepted for any damage caused by faulty connections or inappropriate handling.
- Observe the relevant standards, regulations and guidelines on the installation and operation of antenna systems.
- The standards IEC/EN/DIN EN 50083 and IEC/EN/DIN EN 60728 must be observed.
- **For further information please read the assembly instructions for the head-end station used.**
- **Test the software versions of the head-end station and the cassette and update them if necessary. The current software versions can be found at "www.gss.de".**



Take action to prevent static discharge when working on the device!



Electronic devices should never be disposed of in the household rubbish. In accordance with directive 2002/96/EC of the European Parliament and the European Council from January 27, 2003 which addresses old electronic and electrical devices, such devices must be disposed of at a designated collection facility. At the end of its service life, please take your device to one of these public collection facilities for proper disposal.

2 General information

2.1 Packing contents

- | | |
|-------------------------------|------------------------------|
| 1 cassette HDMT 2180 P CI | |
| 2 HF cables | 1 CD (assembly instructions) |
| 1 Brief assembly instructions | |

2.2 Meaning of the symbols used



Important note



General note

- Performing works

2.3 Technical data

The devices meet the following EU directives:

2006/95/EC, 2004/108/EC

The product fulfils the guidelines and standards for CE labelling.

Unless otherwise noted all values are specified as "typical".

HF input

Frequency range:.....	177,5 ... 858 MHz
Level range:	60 dB μ V ... 80 dB μ V
Channels DVB-T:	C5 ... C12, C21 ... C69
Bandwidth DVB-T.....	7MHz/8MHz
Modulation / Symbol rate DVB-T:	acc. to EN 300744
Channels DVB-C:.....	C5 ... C69
Modulation DVB-C:.....	QAM 16/32/64/128/256
Symbol rate DVB-C:	1...7 MBaud

HF output

Channels:	C2 ... C69 (incl. S2 ... S41)
Frequency range:.....	48.25 MHz ... 855.25 MHz
Standard:	CCIR PAL B/G
Output level:	98 dB μ V
Output level attenuation:.....	0 ... 7 dB
Output impedance:	75 Ω

Video interference level:	57 dB
Video band width:	20 Hz ... 5 MHz
Audio interference level:	60 dB
Audio band width:	40 Hz ... 15 kHz

Connections

HF inputs:	2 IEC sockets
HF output:	1 IEC socket
Connection strip (10-pin):	for supply voltages and control circuits
RS 232 socket:	serial interface for software update
Conditional access:	1 (2 channels can be descrambled)

2.4 Description

The twin transmodulator cassette converts all stations modulated according to DVB-T or DVB-C standard into two PAL-modulated cable signals. The cassette has two HF inputs and one HF output. It is equipped with two channel strips. Each channel strip consists of a digital tuner, a digital signal preparation unit and a modulator. The cassette's channel strips are indicated by "Bx ...A" or "Bx ...B" in the control unit display.

The channel strip "A" can descramble scrambled channels via a corresponding CA module. Depending on the CA module and the smart card, two channels can be descrambled simultaneously with one CA module, with the second one supplied via channel strip "B". Time controlled channel switching is possible by the integrated time control. The control of the cassette takes place via the control unit of the head-end station.

Two LEDs provide an indication of the SAT IF input signal quality based on their colour. If the data of channel strip "A" are used in channel strip "B" the status LED of channel strip "B" is switched off.

The prepared input signals reach the HF output collector of the head-end station via the HF output socket. The common output level of the channel strips can be set at the HF output collector of the head-end station.

When the head-end station is switched on, the two-line LC display briefly shows the software version of the control unit. To operate this cassette the software version of the control unit must be "V 41" or higher. You can find the current operating software for the control unit and the cassette, the software "BE-Flash" and the current assembly instructions on the website "www.gss.de".

The cassette is designed for use in the following head-end stations:
STC 1200, STC 816 and PST 19-1.

2.5 Software query

Control unit

If necessary, you can activate the indication of the software version of the control unit manually:

- Press any two keys on the control unit of the head-end station simultaneously until the display goes dark and afterwards the software version, e.g. “V 41” appears.

Cassette

After activating the cassette the software version of the cassette is displayed (see page 16).

3 Assembly

3.1 Installing the cassette



- Ensure the head-end station is mounted so it will not be able to vibrate. Avoid, for example, mounting the head-end station onto a lift shaft or any other wall or floor construction that vibrates in a similar way.
- Before installing or changing a cassette unplug the power cable from the mains power socket.
- Remove the fastening screws ① of an unoccupied slot from the bracket of the head-end station.
- Insert the cassette in this slot and push it into the housing.
- Align the cassette and apply slight pressure to connect it to the connections of the board and the HF bus bar.
- Fasten the cassette with the screws ①.

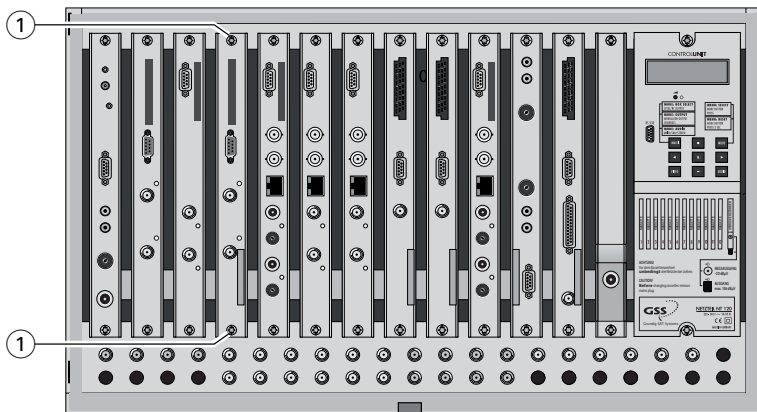

3.2 EMC regulations



To comply with the current EMC regulations, it is necessary to connect the lines leading in and out of the head-end station using cable terminals.



The attenuation of shielding of the connection lines must meet the requirements for "Class A".



When mounting the cassette in a head-end station which is installed in a 19" cabinet, make sure the connections leading in and out for the 19" cabinet are made using cable terminals.

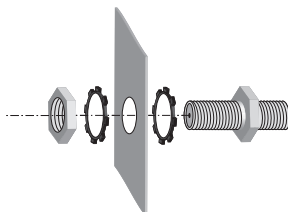

- Insert the required number of cable terminals in the openings provided in the head-end station or in the 19" cabinet.
 → Cable terminals are not included in the scope of delivery.



Tighten the nut on the cable terminal until the teeth on the lock washer have penetrated the exterior coating and a good connection is made between the housing and cable terminal.

3.3 Overview of the cassette

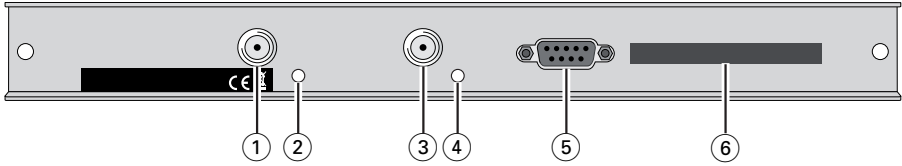

- ① HF input (channel strip "B")
- ② Status LED of the channel strip "B"
- ③ HF input (channel strip "A")
- ④ Status LED of the channel strip "A"
- ⑤ D-SUB socket "RS 232"
- ⑥ Slot for a CA module

3.4 Connecting the cassette

- Connect the HF input ③ (channel strip "A") and HF input ① (channel strip "B") to the respective outputs of the HF input distributor.
- Connect the head-end station to the mains power supply.

3.5 Updating the software

The RS 232 interface of the cassette ⑤ enables you to use a PC or a notebook and the "BE-Flash" software to update the software of the cassette. You can find the "BE-Flash" software and the current operating software of the cassette at the website "www.gss.de".

- Use a "one-to-one cable" to connect the cassette's RS 232 interface and the PC according to the wiring scheme below.



→ If necessary use a standard RS-232/USB adapter.

- Start the "BE-Flash" software and update the software of the cassette.

3.6 Retrofitting a CA module

The cassette is equipped with a common interface. It allows you to connect a CA module for various scrambling systems and service providers. Scrambled channels can only be descrambled with a CA module suitable for the scrambling system and the corresponding smart card. The smart card contains all the information for authorisation, descrambling and subscription.



- Check with the distributor or manufacturer of the CA module to be used to ensure that it is suitable for descrambling several channels.
- **The hardware and software of this cassette have been thoroughly prepared and tested.**
- **Any changes made by program providers to the structures in the program data might impair or even prevent this function.**
- When working with the CA module, please read the corresponding operating manual from the respective provider.

- Insert the smart card (1) into the CA module (2) so that the chip (3) on the smart card faces the thicker side (top) of the CA module.
- Insert the CA module into the guide rails of the CA slot (4) with the top side of the CA module facing the top side of the cassette.
- Push the CA module without canting into the guide rails of the CA slot (4) and contact it to the common interface.

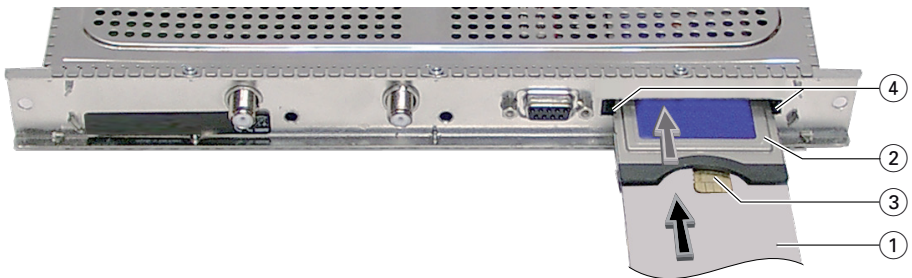

4 The control panel at a glance

4.1 Menu items

Program the cassette using the buttons on the control unit of the head-end station. The two-line display of the control unit then shows the menus. The parameters and functions to be set are underlined.

Use the **MODE** key to select the following main menu items:

- Cassette
- Channel strip
- Modulator / output level
- TV standard
- Channel- / frequency selection
- Output channel / output frequency
- Input channel / input frequency
- Input signal / - symbol rate
- Channel selection
- TV station sound / Volume
- Audio mode / Audio output
- Picture format / Teletext
- Test lines
- Regional window
- Subtitle
- Time zone and summer time
- Timer settings

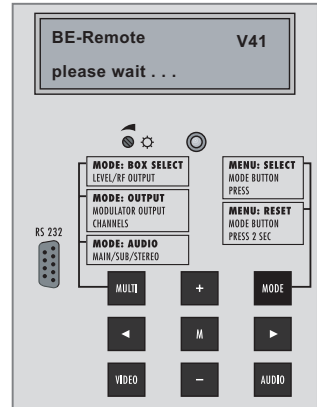

4.2 Control panel

The key pad on the head-end station is used to scroll through the menus and menu items one at a time:

- MODE** scrolls forward through the menus.
- ◀ / ▶** select parameters in the menus.
- + / -** set values, initiate actions.
- MULTI** selects sub-menus.
- AUDIO** scrolls backward through the menus.
- M** saves all entries.



5 Programming

5.1 Preparation

- Test the software versions of the head-end station and the cassette and update them if necessary.
The current software versions can be found on the website "www.gss.de".
- Connect the test receiver to the HF output or the test output of the head-end station.
- Set the output channel / output frequency of the cassette (page 20) and adjust the TV test receiver to this channel / this frequency.
- Switch on the modulator if necessary (page 18).
- Balance the output levels of the channel strips "A" and "B" if the difference in level is ≥ 1 dB (see chapter "Modulator settings / Adjusting the output levels of the channel strips", page 18).

5.2 Programming procedure

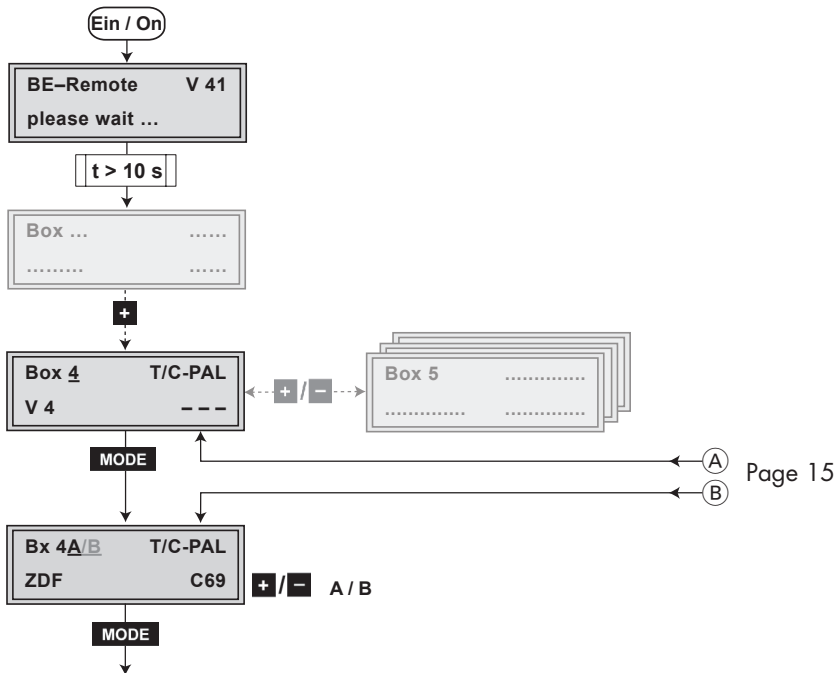

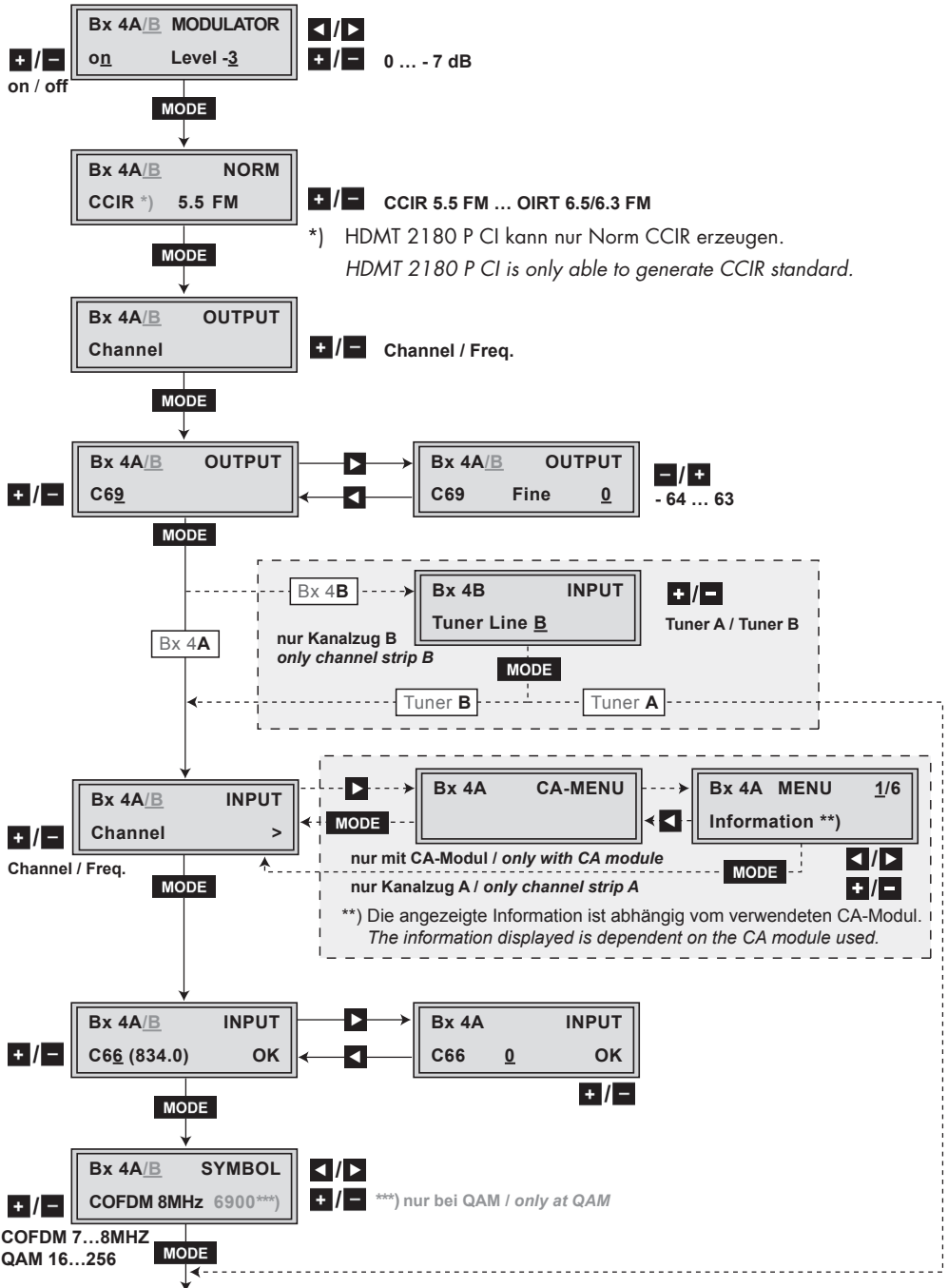

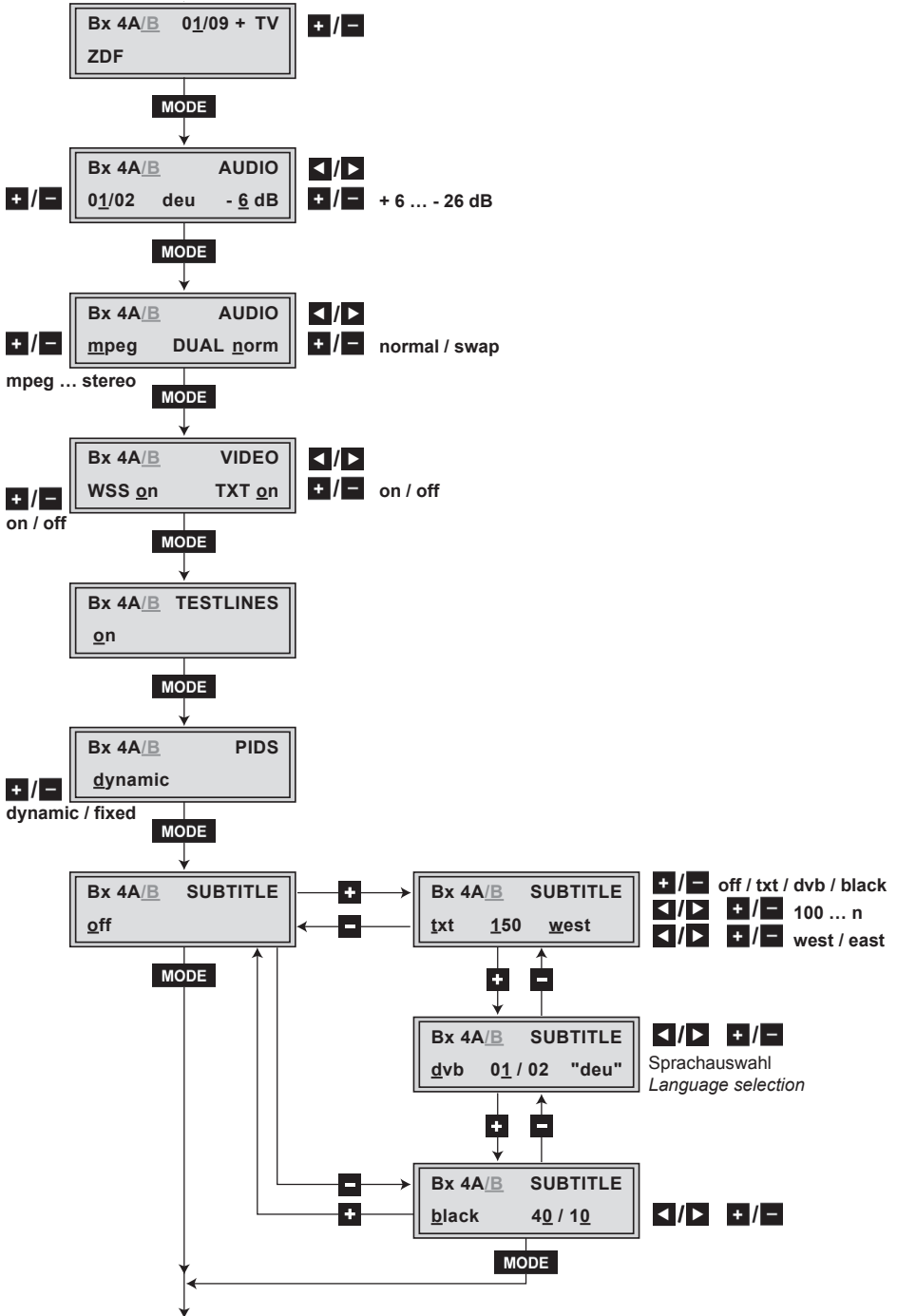

5.3 Programming the cassette

- Pressing the **MODE** button for longer than 2 seconds cancels the programming procedure. This takes you back to the program item "Selecting the cassette" from any menu. Any entries that have not been saved are reset to the previous settings.
- Entries in the menus can be saved by pressing the **M** key. You are taken back to the "Selecting the cassette" menu item.
- Using the **AUDIO** button previous menus can be activated.
- Switch on the head-end station
 - The display shows the software version of the head-end station (e.g. "V 41").
 - The processor reads the cassettes' data (approx. 10 seconds).

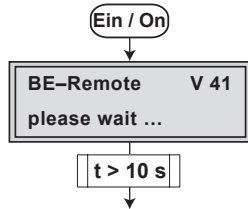

Selecting the cassette, displaying the software version

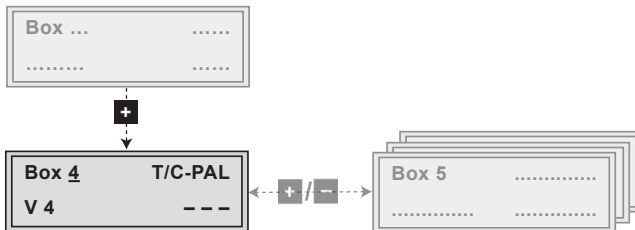

- Select the cassette you want to program (e.g. **Box 4**) by repeatedly pressing the button **+**.
 - The display shows e.g. the menu "Box 4 T/C-PAL":
 - "Box 4" stands for slot 4
 - "T/C-PAL" type of cassette
 - "V 4" software version of the cassette

Selecting the channel strip

Selecting channel strip "A"

- Press the **MODE** button to select channel strip "A".

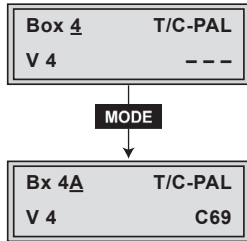

→ Button **-** selects the previous cassette.

Selecting channel strip "B"

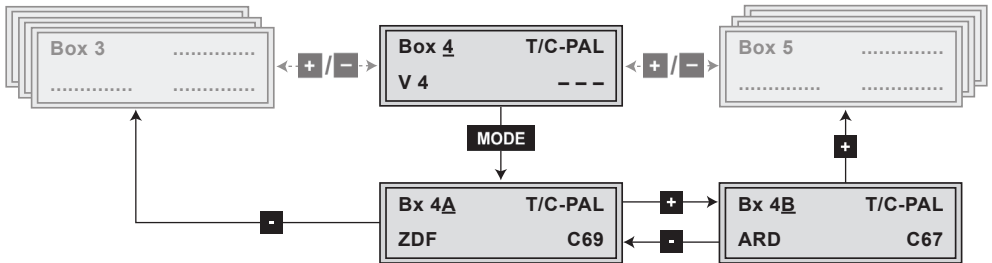

- Press the **+** button to select channel strip "B".

→ The display shows e.g. the menu **"Bx 4B T/C-PAL"**
ARD C67

"Bx" stands for cassette (box),
 "4" for slot 4,
 "B" for channel strip "B"
 "QPSK-PAL" Type of cassette
 "C67" adjusted channel

→ Button **-** selects channel strip "A".

→ Button **+** selects the following cassette.

- Press the **MODE** button.

→ The "Switching the modulator off or on", "Adjusting the output levels of the channel strips" – **"MODULATOR"** menu is activated.

Switching the modulator off or on

Adjusting the output levels of the channel strips

In this menu, you can switch off and on the modulator and set the HF output levels of the channel strips "A" and "B" to the same values.



Switching the modulator off or on

- By pressing **+** / **-**, switch the modulator of the channel strip "off" or "on".
→ In position "off" the menu item "Level" is inactive.

Adjusting the output levels of the channel strips

- Measure and note down the output level of channel strip "A".
 - Activate menu item "Selecting the channel strip" using the **AUDIO** button and select channel strip "B".
 - Activate the "MODULATOR Level" menu.
 - If necessary switch on the modulator.
 - Measure and note down the output level of channel strip "B".
 - Select the channel strip with the higher HF output level.
 - Activate the "MODULATOR" menu and position the cursor under "Level ...".
 - By pressing **-** adjust the higher output level of one channel strip to the lower output level of the other channel strip incrementally from "0" to "-7"dB.
 - Activate channel strip "A".
-
- Press the **MODE** button.
→ The "Setting the TV standard of the output signal" – "NORM" menu is activated.

Setting the TV standard of the output signal

In this menu you can set the TV standard of the output signal.

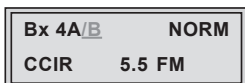

- Press **+/ -** to select the TV standard of the output signal.
→ Select **"CCIR 5.5 FM"** for cassette HDMT 2180 P CI
- Press the **MODE** button.
→ The "Selecting channel / frequency setting" – **"OUTPUT"** menu is activated.

Selecting channel / frequency setting

In this menu, you can choose the channel or frequency setting for the adjustment of the HF output.

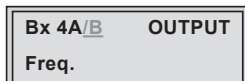
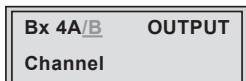

- Use **+/ -** to select channel setting **"Channel"** or frequency setting **"Freq."**.
- Press the **MODE** button.
→ The "Setting the output channel" or "Setting the output frequency" – **"OUTPUT"** menu is activated.

Setting the output channel

In this menu you set the output channel of the channel strip.

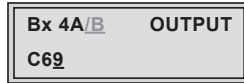

- Use the **+**/**-** buttons to set the output channel.

Setting the fine-tuning



Only change the fine-tuning in exceptional circumstances, since once you change it, all connected television sets of the cable system must be adjusted to match it by means of corresponding fine-tuning corrections.

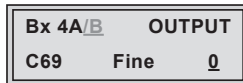

- Press the **▶** button.
→ "FINE 0" appears in the display.
- Set the fine-tuning using the **+**/**-** buttons ("-64" ... "63").
- Press the **◀** button to return to the main menu.
- Press the **MODE** button (continue on page 21).

Setting the output frequency

In this menu you set the output frequency of the channel strip.

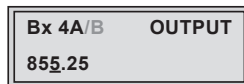

- Use the **◀**/**▶** buttons to place the cursor under the digit to be set for the frequency display then use **+**/**-** to set the output frequency wished.
- Press the **MODE** button.

Channel strip A:

—> The “Selecting channel or frequency setting (input)” – “**INPUT Channel**” menu is activated (page 21).

Channel strip B:

—> The “Selecting the Tuner” – “**INPUT Tuner Line**” menu is activated.

Selecting the Tuner (only channel strip B)

In this menu you can select which tuner (input A or B) is to use (only for channel strip B). So the transport streams of the receiving stage “**A**” can be split into two output transport streams. If “Tuner Line A” is selected **it is possible to descramble two scrambled channels** using a CA module and a corresponding smart card.

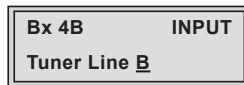

- Press the **+**/**-** buttons to select the tuner wished.
- Press the **MODE** button.

Selection Tuner Line A:

—> The “Channel selection” – e.g. “**Bx 4B 01 / 09+ TV**” menu is activated (page 24).

Selection Tuner Line B:

—> The “Selecting channel or frequency setting” – “**INPUT Channel**” menu is activated (page 21).

Selecting channel or frequency setting (input)

Configuring the CA module (only channel strip A)

In this menu, you can select the channel or frequency setting for the adjustment of the HF input.

If used, in this menu the settings of a CA module can be done (dependent on the CA module).

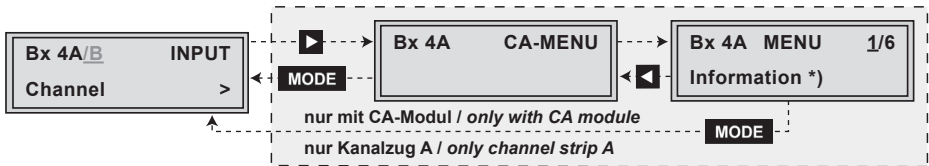

Selecting channel or frequency setting (input)

- Use **+**/**-** buttons to select channel setting “**Channel**” or frequency setting “**Freq.**”.

Configuring the CA module (only channel strip A)

- Press the **▶** button to activate the menu of the CA module.



—> The display shows e.g.: **Bx 4A MENU 01/06**
Information

Meaning of the indicators:

- “**Bx 4A**” – Slot 4, channel strip “**Tuner A**”
- “**MENU**” – The menu of the CA module is activated.
- “**01/06**” – The first of six menu items is activated.
- “**Information**” – dependent on the CA module.

For the explanation of further details please use the operating instructions of the CA module used.

- Use the **+**/**-** buttons to select the menu desired.
- Press the **▶** button to activate the menu.
- Use the **+**/**-** buttons to select the function desired.
- To set the CA module use the **◀**/**▶** and **+**/**-** buttons.
- All settings are saved by pressing the **M** button.
- Press the **MODE** button to return to the “Selecting channel or frequency setting (input)” – “**INPUT Channel**” menu.

- Press the **MODE** button.

—> Depending on the setting the “Setting the input channel” or “Setting the input frequency” – “**INPUT**” menu is activated.

Setting the input channel

Setting the input frequency

In this menu you set the input channel or the input frequency of the channel strip.



If three dots " ..." appear in the second line of the display, the cassette is in the "station search" mode. Please wait until the process has finished.

Once the HF receiver has synchronised to the input signal "OK" is shown in the display.

If "--" appears in the second line of the display, there is no input signal present. Check the configuration of the antenna system and head-end station as well as the preceding settings of the cassette.

Setting the input channel

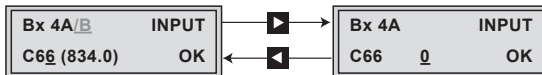

- Use the **+**/**-** buttons to set the input channel wished.
- If required, press the **▶** button to activate the menu for the fine tuning (additionally "0" appears in the display).
- Use the **+**/**-** buttons for the fine tuning of the input channel.
- Press the **◀** button to return to the main menu.

Setting the input frequency

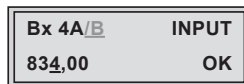

- Use **◀**/**▶** buttons to position the cursor under the digit of the frequency displayed to be set.
- Press **+**/**-** to set the respective digit of the input frequency needed.

A status LED indicates the quality of the received transport stream:

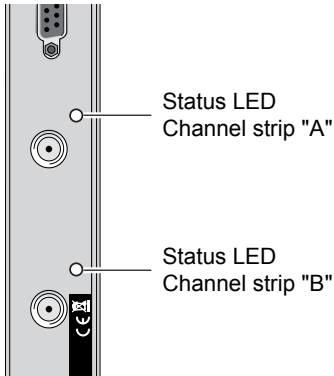

LED indicator	Indication
Green	Signal quality is good
Yellow	Signal quality is poor
Red	No signal
The LED of channel strip "B" is switched off.	In the channel strip "B" the data of channel strip "A" are used.

- ② Status LED (channel strip "B")
- ④ Status LED (channel strip "A")

- Press the **MODE** button.
- The "Setting the input signal / symbol rate" – **"SYMBOL"** menu is activated.

Setting the input signal

Setting the input symbol rate

In this menu you can select the kind of modulation of the input signal. If a QAM modulated signal is selected the symbol rate can be set.

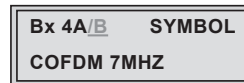
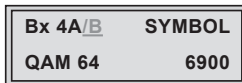

Set the input signal

- With the **+**/**-** buttons set the input signal wished: COFDM 7MHz/8MHz or QAM 16/32/64/128/256

Set the input signal rate (only if a QAM input signal is selected)

- With the **◀**/**▶** buttons to position the cursor the digit of the symbol rate to be set.
- With the **+**/**-** buttons set the symbol rate wished.
- Press the **MODE** button.
- The "Channel selection" – e.g. **"Bx 4A 01/09+ TV"** menu is activated.

Channel selection

As soon as the automatic station search has found all of the TV or radio channels, the corresponding data appear in the display of the head-end station.

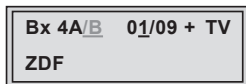

Meaning of the terms displayed in this example:

"**Bx 4A**" Slot 4, channel strip "**A**".

"**01/09**" The 1st of 9 channels is displayed

"**+**" means that the sound of the TV programme currently being shown is being broadcast in several languages.

"**TV**" Television channel type

"**ZDF**" Station name

Further possible terms displayed:

"**RA**" Radio channel type

For radio stations, the screen of the connected TV or test receiver is darkened. A menu appears on the screen informing you about the radio station currently selected, the name of the broadcaster, the current time, the title of the current programme along with what time it started and finishes, as well as the title of the following programme.

"*****" The star means that the TV or radio station selected is scrambled. To enable the stations, the CA module and the appropriate smart card of the station provider are required.

→ If a service number (e.g. "131") appears instead of "**TV**" or "**RA**", this indicates that an unnamed station or an undefined data stream is being received.

- To select the TV or radio station wished out of the transport stream, use the **+/ -** buttons.

- Press the **MODE** button.

→ The "Selecting the TV station sound", "Setting the volume level" – "**AUDIO**" menu is activated.

Selecting the TV station sound

Setting the volume level

If two sound options in different languages or Dual sound ("2ch") are broadcast for a TV station, you can select the desired audio stream from the transport stream in this menu.

Additionally in this menu, you can balance unequal volume levels of TV and radio stations in the various channel strips.



Selecting the TV station sound

- Press **+**/**-** to select the desired sound option (e.g. "deu" – German).

Setting the volume level

- Use **◀**/**▶** to position the cursor under the audio level set (e.g. "- 6 dB").
- Set the volume level to the same level as the levels of the other output channels using the **+**/**-** buttons (+6 dB ... -26 dB), if necessary.

- Press the **MODE** button.

→ The "Setting the audio mode", "Setting audio output" – "AUDIO mpeg / Dual ..." menu is activated.

Setting the audio mode

Setting the audio output

In this menu you can define whether the **Mono**, **Stereo** or **Dual Tone** signal from the MPEG data stream or the VPS signaling (if available) is to be used ("mpeg" ... "stereo").

In addition in this menu you can swap the languages for TV channels with dual tone.

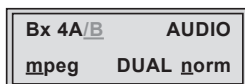

Setting the audio mode

- Press the **+**/**-** buttons to set the data stream ("mpeg" ... "stereo").

Setting the audio output

- Use **◀/▶** to position the cursor under **"DUAL ..."**.
- Press **+/-** to swap languages (**"Dual normal"** / **"Dual swap"**).

- Press the **MODE** button.
→ The **"Adjusting the picture format"**, **"Switching teletext mode off/on"** – **"VIDEO"** menu is activated.

Adjusting the picture format

Switching teletext mode off/on

If problems with the automatic picture format switchover (e.g. 4:3, 16:9, Letter-box) arise with the connected devices, you can switch **"off"** the Wide-Screen-Signaling (WSS) in this menu.

In addition in this menu you can define whether the teletext of the channel set is transmitted or not.

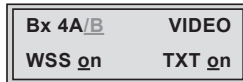

Adjusting the picture format

- Press **+/-** to switch Wide-Screen-Signaling **"on"** or **"off"**.

Switching teletext mode off/on

- Use **◀/▶** to position the cursor under **"TXT ..."**.
- By pressing **+/-** the teletext mode can be switched **"on"** or **"off"**.

- Press the **MODE** button.
→ The **"Activating test lines"** – **"TESTLINES"** menu is activated.

Activating test lines

For specific applications test lines can be inserted in the teletext in this menu.

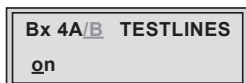

- Using the **+**/**-** buttons switch the test lines **"on"** or **"off"**.
- Press the **MODE** button.
→ The "Locking the regional window" – **PIDS:**" menu is activated.

Locking the regional window

In this menu the dynamic switch over between the main channel and the associated regional channels can be deactivated.

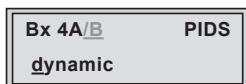

- Press **+**/**-** to switch on the dynamic regional switch over (**"dynamic"**) or off (**"fixed"**).
- Press the **MODE** button.
→ The "Subtitle settings" – **"SUBTITLE"** menu is activated.

Subtitle settings

In this menu you define whether subtitles are to be transmitted or not. If the transmission of subtitles is switched on (**"txt"**) subtitles transmitted in the teletext are displayed directly in the station. For this you can activate the page wished. In addition in this menu you define the characters to display the languages. For the Western European languages set **"West"**; for Eastern European languages set **"East"**.

If DVB subtitles are received, the language can be selected in this menu. But the respective menu only is displayed if the DVB data stream contains subtitles. Additionally in this menu a part of the TV picture is blanked, i. e. covered by a black strip. The vertical dimension and the position of the strip can be set.

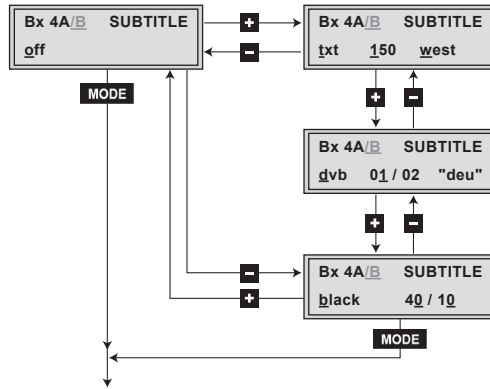

- Press **+**/**-** to switch on the "Teletext operation" ("**txt**"), "Transmission of subtitles" ("**dvb**") or "Frame suppression" ("**black**") or to switch off the "Subtitle settings" ("**off**").
- If the subtitle settings menu is switched "**off**" press the **MODE** button and continue with chapter "Setting the time zone and summer time" (page 30).

Setting teletext subtitle pages

- If teletext operation / transmission of subtitles is switched on ("**txt**") use the **◀**/**▶** buttons to position the cursor under e.g. "**150**".
- If necessary, press **◀**/**▶** to set the cursor under the 100th, 10th and 1st digit positions of the teletext subtitle page displayed and enter the numbers of the teletext subtitle page wished with the **+**/**-** buttons.

Setting the teletext standard

- To set the teletext standard, if necessary, position the cursor under e.g. "**west**".
- Press **+**/**-** to set teletext standard wished ("**west**" / "**east**").

DVB subtitle

- If you want to activate subtitle pages from the DVB data stream, if available, activate "**SUBTITLE dvb**" menu in the "**txt**" menu item using the **+**/**-** buttons.
- Position the cursor under language selection (e.g. "**01/02**") using the **◀**/**▶** buttons.
- Activate the language you want using **+**/**-**.
- The language selected is displayed in the menu (e.g. "**deu**" for German).

Frame suppression

- If frame suppression is wished, activate the "**SUBTITLE black**" menu in the "**txt**" menu item using the **+**/**-** buttons.
- Position the cursor under the vertical position display of the frame suppression (e.g. "**40**") using the **◀**/**▶** buttons and set the position wished in the TV picture.
- Position the cursor under the vertical dimension display of the frame suppression (e.g. "**10**") using the **◀**/**▶** buttons and set the dimension wished.
- Press the **MODE** button.
→ The "Setting the time zone and summer time" – "**TIME**" menu is activated.

Setting the time zone and summer time

This setting is necessary for "Radio display" and time-controlled channel switching. The internal clock of the cassette synchronises automatically to Greenwich Mean Time, longitude "0" (GMT). So that the programmes can be correctly displayed, the time zone (offset) that your location is in relation to GMT can be changed. Normally the time zone is taken from the transponder used.

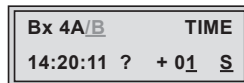

- "14:20:11 ?" Time (GMT + offset)
The current time is displayed when the question mark "?" disappears.
- " + 01" + 1 hour (offset to GMT) is set.
- "S" Summer time support is switched on.

Example:

Summertime support for the time zone of Germany (GMT + 1 hour) is in: If "**S**" is switched on, one hour is added in addition to offset ("**+ 01**") during summer time.

- Using the **+**/**-** buttons set the time zone you live in ("**-12**" ... "**+12**").
- To set summer time support position the cursor under "**S**" using the **◀**/**▶** buttons.
- Using the **+**/**-** buttons switch summer time support on ("**S**") or off ("**-**").
- Press the **MODE** button.

→ The "Setting time-controlled, alternative channels" – "**TIMER**" menu is activated.

Setting time-controlled, alternative channels

In this menu alternative channels can be switched on or off time-controlled. During the time set ("**TIMER on**") the channel set in the timer is transmitted.

Switching the timer on and off

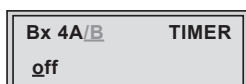

- Use the **+**/**-** buttons to switch the timer "**on**" or "**off**".
- If the timer is switched off continue with chapter "Saving settings" (page 34).

Setting the duty cycle

In this menu you set the duty cycle of the alternative channel.

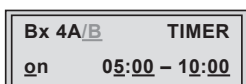

- Use the **◀**/**▶** buttons to position the cursor under the digits of the switch on time to be set (e.g. "**05:00**").
- Press **+**/**-** to set the desired switch on time.
- Use the **◀**/**▶** buttons to position the cursor under the digits of the switch off time to be set (e.g. "**10:00**").
- Press **+**/**-** to set the desired switch off time.
- Press the **MODE** button.
- The "Setting the days of the week" – "**TIMER Days**" menu is activated.

Setting the days of the week

In this menu you set the days on which the timer has to be active.

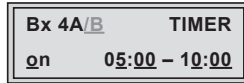

The letters "M T W T F S S" mean:

- M – Monday
- T – Tuesday
- W – Wednesday
- T – Thursday
- F – Friday
- S – Saturday
- S – Sunday

- Use the ◀/▶ buttons to position the cursor under the day to be set.
- Press +/- to switch on (e.g. "M") or off ("–") the day on which the timer should and should not be active.

- Press the **MODE** button.
 - The "Selecting channel / frequency setting (input)" – "TIMER INPUT Channel" menu is activated.

 - If the combination "channel strip B" with "tuner line A" is set in the menu "Selecting the Tuner" – "INPUT" (page 21) is set, the menu "Channel selection (timer)" – e.g. "Bx 4A 01/07+ TV" is activated (page 33).

Selecting channel or frequency setting (timer, input)



- For setting see page 21.

- Press the **MODE** button.
 - The "Selecting input channel or input frequency setting (timer)" – "TIMER INPUT" menu is activated (page 33).

Selecting input channel or input frequency setting (timer)

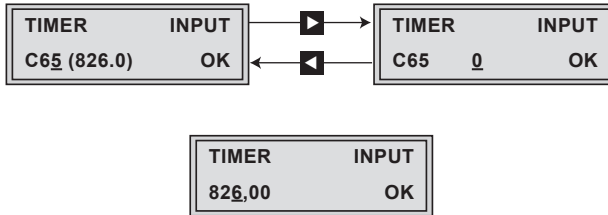

—> For setting see page 21.

- Press the **MODE** button.

—> The “Setting the input signal / symbol rate” – “**TIMER SYMBOL**” menu is activated.

Setting the input signal / symbol rate (timer)



—> For setting see page 23.

- Press the **MODE** button.

—> The “Channel selection (timer)” – e.g. “**Bx 4A 01/07+ TV**” menu is activated.

Channel selection (timer)

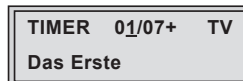

—> For setting see page 24.

- Press the **MODE** button.

—> The “Selecting the TV station sound / Setting the volume level (timer)” – “**TIMER AUDIO**” menu is activated.

Selecting the TV station sound / Setting the volume level (timer)

TIMER	AUDIO
01/02	deu - 6 dB

—> For setting see page 25.

Saving settings

- Press the **M** button.
 - > The settings are saved.
 - > You are returned to the “Selecting the cassette” menu (page 16).
 - > By pressing the **MODE** button, you will be returned to the menu item “Selecting the channel strip” **without** saving the programmed data (page 17).

6 Final procedures



After installing the head-end station, upgrading accessories or installing cassettes it is necessary to tighten all cable connections, cable terminals and cover screws in order to maintain compliance with current EMC regulations securely.

- Securely tighten the cable connections fingertight using an appropriate open-ended spanner.
- Measure the output levels of the other cassettes and tune them to a uniform output level using the appropriate level controls or software dependent on the head-end station used. Please regard the assembly instructions of the respective head-end station.
 - > In order to prevent interference within the head-end station and the cable system, the output levels of the analogue cassettes must be set higher by 8 dB compared to digital cassettes.
- Mount the front cover (see assembly instructions of the head-end station).

7 Channel and frequency tables

CCIR – Band I/III (Frequency grid 7 MHz)

Kanal Channel	Bildträgerfrequenz Picture carrier frequency [MHz]	Kanal Channel	Bildträgerfrequenz Picture carrier frequency [MHz]	Kanal Channel	Bildträgerfrequenz Picture carrier frequency [MHz]	Kanal Channel	Bildträgerfrequenz Picture carrier frequency [MHz]	Kanal Channel	Bildträgerfrequenz Picture carrier frequency [MHz]
C 2	48.25	S 5	133.25	C 5	175.25	C 11	217.25	S 15	259.25
C 3	55.25	S 6	140.25	C 6	182.25	C 12	224.25	S 16	266.25
C 4	62.25	S 7	147.25	C 7	189.25	S 11	231.25	S 17	273.25
S 2	112.25	S 8	154.25	C 8	196.25	S 12	238.25	S 18	280.25
S 3	119.25	S 9	161.25	C 9	203.25	S 13	245.25	S 19	287.25
S 4	126.25	S 10	168.25	C 10	210.25	S 14	252.25	S 20	294.25

CCIR – Hyperband (Frequency grid 8 MHz)

Kanal Channel	Bildträgerfrequenz Picture carrier frequency [MHz]	Kanal Channel	Bildträgerfrequenz Picture carrier frequency [MHz]	Kanal Channel	Bildträgerfrequenz Picture carrier frequency [MHz]	Kanal Channel	Bildträgerfrequenz Picture carrier frequency [MHz]	Kanal Channel	Bildträgerfrequenz Picture carrier frequency [MHz]
S 21	303.25	S 25	335.25	S 29	367.25	S 33	399.25	S 37	431.25
S 22	311.25	S 26	343.25	S 30	375.25	S 34	407.25	S 38	439.25
S 23	319.25	S 27	351.25	S 31	383.25	S 35	415.25	S 39	447.25
S 24	327.25	S 28	359.25	S 32	391.25	S 36	423.25	S 40	455.25
								S 41	463.25

CCIR – Band IV/V (Frequency grid 8 MHz)

Kanal Channel	Bildträgerfrequenz Picture carrier frequency [MHz]	Kanal Channel	Bildträgerfrequenz Picture carrier frequency [MHz]	Kanal Channel	Bildträgerfrequenz Picture carrier frequency [MHz]	Kanal Channel	Bildträgerfrequenz Picture carrier frequency [MHz]	Kanal Channel	Bildträgerfrequenz Picture carrier frequency [MHz]
C 21	471.25	C 31	551.25	C 41	631.25	C 51	711.25	C 61	791.25
C 22	479.25	C 32	559.25	C 42	639.25	C 52	719.25	C 62	799.25
C 23	487.25	C 33	567.25	C 43	647.25	C 53	727.25	C 63	807.25
C 24	495.25	C 34	575.25	C 44	655.25	C 54	735.25	C 64	815.25
C 25	503.25	C 35	583.25	C 45	663.25	C 55	743.25	C 65	823.25
C 26	511.25	C 36	591.25	C 46	671.25	C 56	751.25	C 66	831.25
C 27	519.25	C 37	599.25	C 47	679.25	C 57	759.25	C 67	839.25
C 28	527.25	C 38	607.25	C 48	687.25	C 58	767.25	C 68	847.25
C 29	535.25	C 39	615.25	C 49	695.25	C 59	775.25	C 69	855.25
C 30	543.25	C 40	623.25	C 50	703.25	C 60	783.25		

Service:

Phone: +49 (0) 911 / 703 2221

Fax: +49 (0) 911 / 703 2326

Email: service@gss.de